

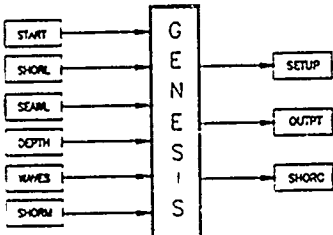

US Army Corps of Engineers

AD-A217 305

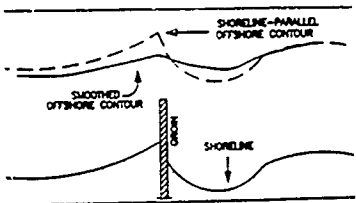
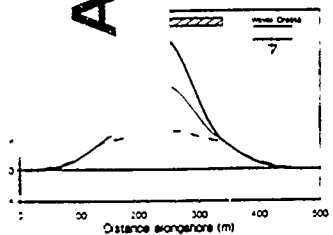
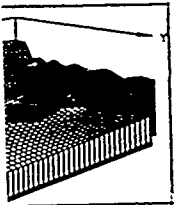

GENESIS: GENERALIZED MODEL FOR SIMULATING SHORELINE CHANGE

Report 1

TECHNICAL REFERENCE

by

Hans Hanson

Department of Water Resources Engineering
Lund Institute of Science and Technology
University of Lund
Box 118, Lund, Sweden S-221 00

and

Nicholas C. Kraus

Coastal Engineering Research Center

DEPARTMENT OF THE ARMY
Waterways Experiment Station, Corps of Engineers
3909 Halls Ferry Road, Vicksburg, Mississippi 39180-6199

DTIC
ELECTE
JAN 29 1990
D & D



December 1989

Report 1 of a Series

Approved For Public Release; Distribution Unlimited

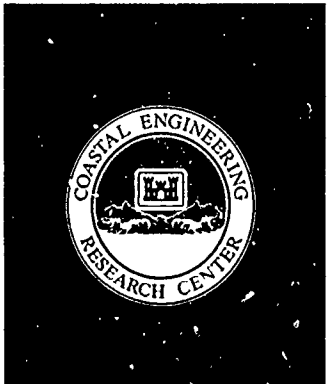

Prepared for DEPARTMENT OF THE ARMY
US Army Corps of Engineers
Washington, DC 20314-1000

Under Surf Zone Sediment Transport Processes
Work Unit 34321 and Shoreline and Beach
Topography Response Modeling Work Unit 32530

90 01 29 003

**Destroy this report when no longer needed. Do not return
it to the originator.**

**The findings in this report are not to be construed as an official
Department of the Army position unless so designated
by other authorized documents.**

**The contents of this report are not to be used for
advertising, publication, or promotional purposes.
Citation of trade names does not constitute an
official endorsement or approval of the use of
such commercial products.**

REPORT DOCUMENTATION PAGE				Form Approved OMB No. 0704-0188	
1a. REPORT SECURITY CLASSIFICATION Unclassified			1b. RESTRICTIVE MARKINGS		
2a. SECURITY CLASSIFICATION AUTHORITY		3. DISTRIBUTION/AVAILABILITY OF REPORT Approved for public release; distribution unlimited.			
2b. DECLASSIFICATION/DOWNGRADING SCHEDULE					
4. PERFORMING ORGANIZATION REPORT NUMBER(S) Technical Report CERC-89-19			5. MONITORING ORGANIZATION REPORT NUMBER(S)		
6a. NAME OF PERFORMING ORGANIZATION See reverse.		6b. OFFICE SYMBOL (If applicable)	7a. NAME OF MONITORING ORGANIZATION		
6c. ADDRESS (City, State, and ZIP Code) See reverse.			7b. ADDRESS (City, State, and ZIP Code)		
8a. NAME OF FUNDING/SPONSORING ORGANIZATION US Army Corps of Engineers		8b. OFFICE SYMBOL (If applicable)	9. PROCUREMENT INSTRUMENT IDENTIFICATION NUMBER		
8c. ADDRESS (City, State, and ZIP Code) Washington, DC 20314-1000			10. SOURCE OF FUNDING NUMBERS		
			PROGRAM ELEMENT NO.	PROJECT NO.	TASK NO.
			WORK UNIT ACCESSION NO. 34321 and 32530		
11. TITLE (Include Security Classification) GENESIS: Generalized Model for Simulating Shoreline Change; Report 1, Technical Reference					
12. PERSONAL AUTHOR(S) Hanson, Hans; Kraus, Nicholas C.					
13a. TYPE OF REPORT Report 1 of a series		13b. TIME COVERED FROM _____ TO _____	14. DATE OF REPORT (Year, Month, Day) December 1989		15. PAGE COUNT 247
16. SUPPLEMENTARY NOTATION Available from National Technical Information Service, 5285 Port Royal Road, Springfield, VA 22161.					
17. COSATI CODES			18. SUBJECT TERMS (Continue on reverse if necessary and identify by block number)		
FIELD	GROUP	SUB-GROUP			
			Beach change	Shoreline change	
			Longshore sand transport	Shoreline change model	
			Numerical model	Shore protection	
19. ABSTRACT (Continue on reverse if necessary and identify by block number) This report documents a numerical modeling system named GENESIS _A which is designed to simulate long-term shoreline change at coastal engineering projects as produced by spatial and temporal changes in longshore sand transport. The name "GENESIS" is an acronym that stands for GENERALized Model for SIMulating Shoreline Change. Typical longshore extents and time periods of modeled projects can be in the ranges of 1 to 100 km and 1 to 100 months, respectively, and almost arbitrary numbers and combinations of groins, detached breakwaters, seawalls, jetties, and beach fills can be represented. GENESIS contains what is believed to be a reasonable balance between present capabilities to efficiently and accurately calculate coastal sediment processes from engineering data and the limitations in both the data and knowledge of sediment transport and beach change.					
20. DISTRIBUTION/AVAILABILITY OF ABSTRACT <input checked="" type="checkbox"/> UNCLASSIFIED/UNLIMITED <input type="checkbox"/> SAME AS RPT <input type="checkbox"/> DTIC USERS			21. ABSTRACT SECURITY CLASSIFICATION Unclassified		
22a. NAME OF RESPONSIBLE INDIVIDUAL			22b. TELEPHONE (Include Area Code)	22c. OFFICE SYMBOL	

A

Unclassified

SECURITY CLASSIFICATION OF THIS PAGE

6. NAME AND ADDRESS OF PERFORMING ORGANIZATION (Continued)

University of Lund
Lund Institute of Science and Technology
Department of Water Resources Engineering
Box 118, Lund, Sweden S-221 00

USAEWES, Coastal Engineering Research Center
3909 Halls Ferry Road
Vicksburg, MS 39180-6199

19. ABSTRACT (Continued).

The modeling system is operated through a structured and user-friendly interface so that the operator need not become familiar with detailed aspects of the computer code. This report serves as a technical reference to Version 2 of GENESIS and is also designed to be an operator's manual by providing instructions for using the interface. The methodology for application of the modeling system is described from the perspective of the needs of both engineers and planners who deal with evaluations of shore-protection projects. Capabilities and limitations of the modeling system are presented in the text and through examples, and the report concludes with a fully documented case study involving application of the modeling system and exercise of many of its features, as provided.

Sweden. (ESC)

*



Accession For	
NTIS CRA&I	<input checked="" type="checkbox"/>
DTIC TAB	<input type="checkbox"/>
Unannounced	<input type="checkbox"/>
Justification	
By	
Distribution/	
Availability Codes	
Dist	Area and/or Special
A-1	

Unclassified

SECURITY CLASSIFICATION OF THIS PAGE

PREFACE

The work described herein was authorized as a part of the Civil Works Research and Development Program by Headquarters, US Army Corps of Engineers (HQUSACE). Work was performed under the Surf Zone Sediment Transport Processes Work Unit 34321 and the Shoreline and Beach Topography Response Modeling Work Unit 32592, which are part of the Shore Protection and Restoration Program at the Coastal Engineering Research Center (CERC) at the US Army Engineer Waterways Experiment Station (WES). Messrs. John H. Lockhart, Jr., and John G. Housley were HQUSACE Technical Monitors.

This report was written and the shoreline change modeling system improved over the period from 1 May 1988 through 30 September 1989 by Dr. Hans Hanson, Associate Professor, Department of Water Resources Engineering (DWRE), Lund Institute of Science and Technology, University of Lund (UL), Sweden, and Dr. Nicholas C. Kraus, Senior Scientist, Research Division (RD), CERC. Work performed at the UL was under the administrative supervision of Professor Dr. Gunnar Lindh, Head, DWRE. The CERC portion of the study was under the general administrative supervision of Dr. James R. Houston, Chief, CERC; Mr. Charles C. Calhoun, Jr., Assistant Chief, CERC; Dr. Charles L. Vincent, Program Manager, Shore Protection and Restoration Program, CERC; and Mr. H. Lee Butler, Chief, RD, CERC. The framework of this report was developed and a detailed draft outline written while Dr. Kraus was in residence at DWRE over the period May-June 1988.

Dr. Kraus was Principal Investigator of Work Unit 34321 during the conceptual and model development phase of this study; Ms. Kathryn J. Gingerich, Coastal Processes Branch (CPB), RD, was Principal Investigator during preparation of the working draft of this report, which was used in a September 1989 workshop. Final revision and publication of this report were made under the Shoreline and Beach Topography Response Modeling Work Unit 32592. Mr. Mark B. Gravens, CPB, was Principal Investigator of Work Unit 32592, under the direct supervision of Mr. Bruce A. Ebersole, Chief, CPB.

Ms. Gingerich, Mr. Gravens, and Ms. Julie Dean Rosati, CPB, provided valuable reviews of the report. Ms. Joan Pope, Chief, Coastal Structures and Evaluation Branch, Engineering Development Division, reviewed the case study

and made many clarifications. Ms. Gingerich made substantial editorial contributions in preparation of the draft report used in the workshop and assisted in many details involved with production of this report. Ms. Carolyn Dickson and Mr. Fulton Carson, CPB, prepared most of the computer-generated figures. Ms. Carrie E. Williford, RD, assisted in editing and formatting preliminary drafts of this report. Participants of the September 1989 workshop are acknowledged for suggestions on improvement of this report. This report was edited by Ms. Lee Byrne, Information Technology Laboratory, WES.

COL Larry B. Fulton, EN, was Commander and Director of WES during final report preparation and publication. Dr. Robert W. Whalin was Technical Director.

CONTENTS

	<u>Page</u>
PREFACE	1
LIST OF TABLES	6
LIST OF FIGURES	6
CONVERSION FACTORS, NON-SI TO SI (METRIC) UNITS OF MEASUREMENT	8
PART I: INTRODUCTION	9
GENESIS	9
Mode of Interaction with GENESIS	11
Cautions	13
Scope of This Report	13
PART II: OVERVIEW OF BEACH CHANGE MODELS	15
Need for Models of Shoreline Change	15
Shoreline Change Model and Capabilities	16
Duration and Extent of Simulation	17
Comparison of Beach Change Models	20
Conclusions	24
PART III: SHORELINE CHANGE MODELING AS A TOOL IN THE PLANNING PROCESS	25
Elements of the Planning Process	25
Role of Shoreline Change Modeling	29
Conclusions	31
PART IV: PROJECT EVALUATION AND USES OF GENESIS	32
Scoping Mode and Design Mode	32
Input Data	33
Boundary Conditions	41
Variability in Coastal Processes	42
Calibration and Verification	44
Sensitivity Testing	45
Interpretation of Results	45
PART V: THEORY OF SHORELINE RESPONSE MODELING AND GENESIS	47
Basic Assumptions of Shoreline Change Modeling	47
Governing Equation for Shoreline Change	50
Sand Transport Rates	52
Empirical Parameters	54
Wave Calculation	61
Internal Wave Transformation Model	62
External Wave Transformation Model: RCPWAVE	74

CONTENTS (Continued)

	<u>Page</u>
Limiting Deepwater Wave Steepness	76
Wave Energy Windows	77
Numerical Solution Scheme	81
Grid System and Finite Difference Solution Scheme	84
Lateral Boundary Conditions and Constraints	86
Beach Fill	90
Longshore Transport Rate: Practical Considerations	91
 PART VI: STRUCTURE OF GENESIS	 97
Preparation to Run GENESIS	97
Input Files	102
START	104
SHORL	123
SHORM	124
SEAWL	125
DEPTH	126
WAVES	126
Output Files	129
Error and Warning Messages	136
 PART VII: REPRESENTATION OF STRUCTURES AND BEACH FILL	 138
Types of Structures and Their Effects	138
Grid Cells and Numbers of Structures	138
Representation of Structures	139
Complex Groin Configurations	143
Seawalls	145
Beach Fills	146
Time-Varying Structure Configurations	148
 PART VIII: CASE STUDY OF LAKEVIEW PARK, LORAIN, OHIO	 149
Background	149
Existing Project	152
Assembly of Data	155
Calibration and Verification	166
Sensitivity and Variability Tests	169
Alternative Structure Configurations	173
Five-Year Simulation	175
Summary and Discussion	176
 REFERENCES	 179
 APPENDIX A: REVIEW OF RELATED GENESIS STUDIES	 A1
 APPENDIX B: BLANK INPUT FILES	 B1
START	B1

CONTENTS (Continued)

	<u>Page</u>
SHORL	B4
SEAWL	B5
DEPTH	B5
WAVES	B6
APPENDIX C: ERROR AND WARNING MESSAGES AND RECOVERY PROCEDURES	C1
Error Messages	C1
Warning Messages	C12
Error Messages Issued by the Computer	C13
APPENDIX D: INPUT AND OUTPUT FILES FOR CASE STUDY	D1
START Files	D1
SHORL Files	D8
SEAWL File	D8
WAVES File	D9
OUTPT Files	D16
APPENDIX E: NOTATION	E1
Mathematical Notation	E1
Program Variable Names	E4
APPENDIX F: INDEX	F1

LIST OF TABLES

<u>No.</u>	<u>Page</u>
1 Major Capabilities and Limitations of GENESIS Version 2	20
2 Data Required for Shoreline Change Modeling	36
3 Example Inputs for Complex Structure Configurations in START.DAT . . .	145
4 Sample Entries Illustrating Development of the WAVES File	162
5 Comparison Between Measured and Hindcast Waves	163
6 Calculated Annual Potential Transport Rates	164
7 Modified Average Wave Height Because of Shadowing by Lorain Harbor .	166

LIST OF FIGURES

<u>No.</u>	<u>Page</u>
1 Operation of GENESIS through an interface	10
2 Shoreline change measured near a long groin	18
3 Comparison of beach change models	21
4 Major steps in project planning and execution	26
5 Model coordinate system	34
6 Definition sketch for shoreline change calculation	51
7 Template to determine the effective sand grain size	58
8 Empirical determination of the depth of closure	60
9 Operation of wave transformation models	63
10 Definition of breaking wave angles	66
11 Definition sketch for wave calculation	68
12 Wave angles in contour modification	70
13 Shoreline change as a function of transmission	72
14 Example of representative contour	73
15 GENESIS, RCPWAVE, and the overall calculation flow	75
16 Energy windows and transport calculation domains	78
17 Diffraction coefficient for two sources	80
18 Finite difference staggered grid	85
19 Example of a coordinate system and grid used by GENESIS	98
20 Gated boundary condition	100
21 Combinations of lateral boundary conditions	101
22 Schematic of input and output file structure of GENESIS	102
23 Example START file	120
24 Example SHORL file	123
25 Example SHORM file	125
26 Example SEAWL file	126
27 Example WAVES files	130
28 Example SETUP file	131
29 Example OUTPT file	133
30 Example legal structure placements	140
31 Example illegal structure placements	141
32 Parameters associated with detached breakwaters	142
33 Legal placement of simple groins	143
34 Examples of complex groin and jetty configurations	144

LIST OF FIGURES (Continued)

<u>No.</u>	<u>Page</u>
35 Example illustrating simple seawall configuration	146
36 Example illustrating simple beach fill configuration	147
37 Location map for Lorain, Ohio	150
38 Aerial view of Lakeview Park, 17 November 1979	152
39 Project design, Lakeview Park	154
40 Adjusted measured shoreline positions	160
41 Measured volume changes within the study area	160
42 Result of model calibration	168
43 Result of model verification	169
44 Model sensitivity to changes in K_1 , K_2 , and D_{50}	171
45 Model sensitivity to changes in K_T , $HCNGF$, and $ZCNGA$	172
46 Shoreline change for alternative structure configurations	174
47 Volume change, October 1977-December 1982	177
48 Shoreline change, October 1977-December 1982	177
B1 START file template	B1
B2 SHORL file template	B4
B3 SEAWL file template	B5
B4 DEPTH file template	B5
B5 WAVES file template	B6

CONVERSION FACTORS, NON-SI TO SI (METRIC)
UNITS OF MEASUREMENT

Non-SI units of measurement used in this report can be converted to SI
(metric) units as follows:

<u>Multiply</u>	<u>By</u>	<u>To Obtain</u>
cubic feet	0.02832	cubic meters
cubic yards	0.7646	cubic meters
feet	0.3048	meters
inches	25.4	millimeters
miles (US statute)	1.6093	kilometers
yards	0.9144	meters

GENESIS: GENERALIZED MODEL FOR SIMULATING SHORELINE CHANGE

TECHNICAL REFERENCE

PART I: INTRODUCTION

GENESIS

1. This report documents a numerical modeling system called GENESIS, which is designed to simulate long-term shoreline change at coastal engineering projects. The name GENESIS is an acronym that stands for GENERalized Model for SImulating Shoreline Change. The longshore extent of a typical modeled reach can be in the range of 1 to 100 km, and the time frame of a simulation can be in the range of 1 to 100 months. GENESIS contains what is believed to be a reasonable balance between present capabilities to efficiently and accurately calculate coastal sediment processes from engineering data and the limitations in both the data and knowledge of sediment transport and beach change. The modeling system and methodology for its use have matured through application to numerous types of projects, yet the framework of the system permits enhancements and capabilities to be added in the future.

2. GENESIS simulates shoreline change produced by spatial and temporal differences in longshore sand transport. Shoreline movement such as that produced by beach fills and river sediment discharges can also be represented. The main utility of the modeling system lies in simulating the response of the shoreline to structures sited in the nearshore. Shoreline change produced by cross-shore sediment transport as associated with storms and seasonal variations in wave climate cannot be simulated; such cross-shore processes are assumed to average out over a sufficiently long simulation interval or, in the case of a new project, be dominated by rapid changes in shoreline position from a nonequilibrium to an equilibrium configuration.

3. The modeling system is generalized in that it allows simulation of a wide variety of user-specified offshore wave inputs, initial beach configurations, coastal structures, and beach fills by means of an interface, as depicted in Figure 1. To run the system, the user need only become familiar with its capabilities and the rules of operation of the interface; details of

the internal structure and algorithms of the computer code need not be learned. Instructions and data are entered through the interface, which, in turn, drives the shoreline change calculation.

4. This report provides the background of GENESIS as a coastal engineering tool, describing both its capabilities and limitations, and serves as a technical reference for operating the modeling system. The methodology of shoreline change modeling is also presented from the perspective of the total developmental environment of a shore protection project, since such modeling cannot be done in isolation from the planning and design processes.

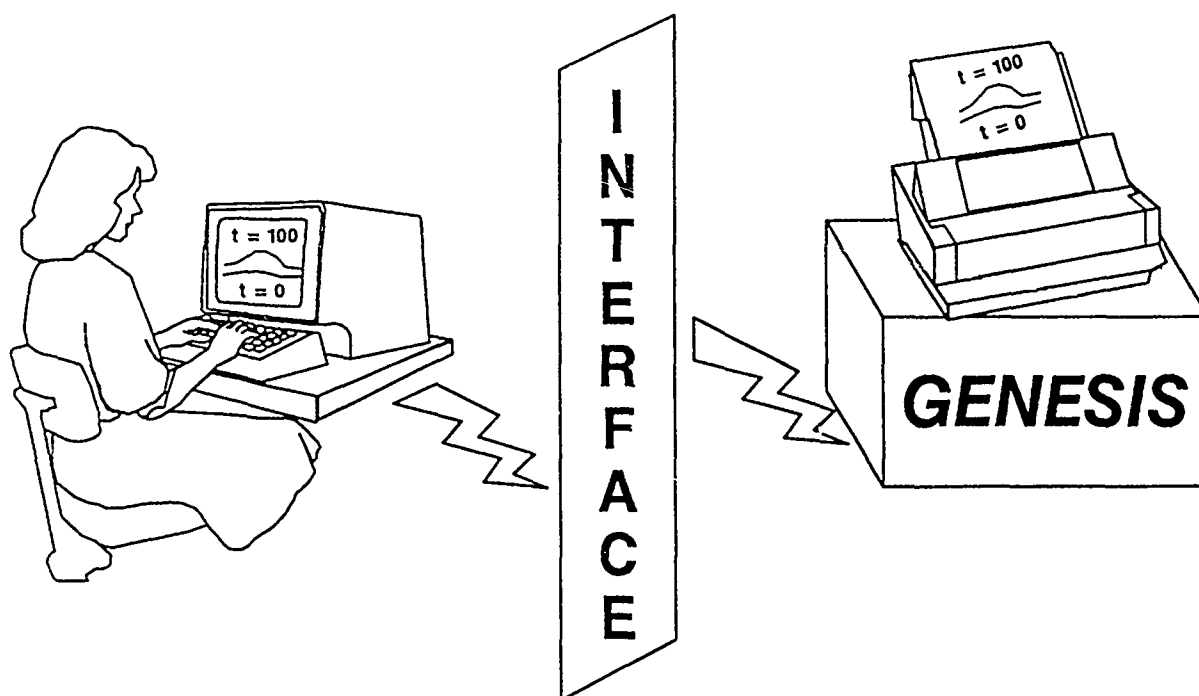

Figure 1. Operation of GENESIS through an interface

5. Prior to development of GENESIS, each application of a shoreline change numerical model required extensive modification of an existing model and, usually, incorporation of special enhancements for the particular application. Considerable time was spent in altering the internal structure of the model computer code and testing the predictions. Through experience gained in a variety of applications over several years, the possibility became

apparent of combining all major features of previous site-specific models into one generalized shoreline change modeling system. A framework for unifying model applications was devised by Hanson (1987, 1989) and centers on the concept of "wave energy windows," described in Part V. Also, an important task was the development of an interface that would allow a user to interact easily with the modeling system without demanding specialized knowledge of the internal code. Much of this report deals with the interface, and technical details and examples are provided to demonstrate use of the interface as well as capabilities and limitations of the modeling system.

6. The predecessor model to GENESIS (Kraus 1988a,b,c,d) was developed in the course of the Nearshore Environment Research Center project conducted in Japan (Horikawa and Hattori 1987). The structure of GENESIS was developed by Hanson (1987) in a joint research project between the University of Lund, Sweden, and the Coastal Engineering Research Center (CERC), US Army Engineer Waterways Experiment Station. Descriptions of GENESIS Version 1 have been given by Hanson (1987, 1989).

7. Version 2 of GENESIS, described here, represents a substantial upgrading of the original model. Major enhancements include:

- a. Wave transmission at detached breakwaters.
- b. Capability to place either a diffracting or nondiffracting groin or jetty on a lateral boundary.
- c. Inclusion of an arbitrary number of wave sources.
- d. Improvement in the interface.
- e. Inclusion of warning messages.

Mode of Interaction with GENESIS

8. GENESIS may be installed on various operating systems having different job control procedures. In this report, discussion of computer hardware and job control, which vary from office to office and change as systems change, is not given. System-dependent details are provided separately with the version of GENESIS at the user's site. For the purpose of this manual, it is assumed that an executable file containing GENESIS is loaded on the system and that it is available to be run. It is also assumed that the

user has familiarity with his or her computer system and basic knowledge of a computer language such as FORTRAN.

9. In general, there are three basic ways to enter data (instructions and numerical values) into a model:

- a. Direct manipulation method (alteration of the source code).
- b. Interactive method (through screen prompts).
- c. Interface method (through data files).

10. The direct manipulation method is not a practical alternative for a large model such as GENESIS because it requires specialized knowledge of the code, admits the possibility of accidentally altering lines of the code, and expends computer resources and time in recompilation. Undocumented or accidental changes in the code at a particular site would greatly increase the difficulty for CERC to support GENESIS users in the field.

11. The interactive input method is popular in commercial software and simple modeling systems, such as the Automated Coastal Engineering System (Leenknecht and Szuwalski 1990), which is composed of modules with relatively small data input. This method was temporarily rejected for use with GENESIS because of the great amount of data input required and difficulty of recovering from an input mistake. For example, a mistype might necessitate restarting the session and rekeying previously entered values. Sophisticated and system-dependent screen control programs would therefore need to be developed to streamline the data entry and allow recovery from errors. In the future, however, it is likely that some portion of the data input for GENESIS (in particular, the "START" file discussed in Part VI) will take advantage of the interactive data input method in the desktop computer version.

12. GENESIS requires input of several data sets that normally do not change from run to run (e.g., measured shoreline positions, offshore wave conditions, and positions of structures). This information must be entered and accessible from data files for production applications. With consideration of the weaknesses of the direct manipulation and interactive methods, input to GENESIS is accomplished through use of data files. By using the interface method, accidental alteration of the code is eliminated, as is time lost in program compilation, and changes in a few instructions or data values do not necessitate reentry of unchanged or correct information. Minor changes

in model input occur frequently during model testing and verification, and the data files serve as a record of the run. The interface method is also compatible with a batch mode of computer operation, whereby jobs are submitted for execution (launched) in an automated manner according to rules of the particular operating system.

Cautions

13. Numerical modeling of shoreline change is a specialized and highly technical area of coastal engineering. Firm understanding of coastal hydrodynamic and sediment transport processes is a prerequisite to operation of a shoreline change simulation model. Incautious use of models and incorrect interpretation of results can lead to costly mistakes. Sophisticated models such as GENESIS should be operated by trained individuals familiar with the coast, and results should be examined in light of the observed behavior of the waves, currents, sediment movement, and beach change that occur along that coast. To operate GENESIS properly, careful reading of this report is required.

Scope of This Report

14. This report has two functions. First, it is an introductory technical reference to GENESIS. The technical material covers the internal working of GENESIS and is intended to increase understanding of the assumptions on which the modeling system is based. Discussion of numerical models of beach change in general and project planning in association with GENESIS are given in Parts II and III, respectively. Planners and coastal managers should read Parts I-IV, as these chapters provide the methodology for use of the modeling system, a background on shoreline change and other coastal processes simulation models, and discussion of the limitations and capabilities of GENESIS. Hands-on users of GENESIS should study the entire report, especially technical aspects presented in Parts V and VI, whereas those who will not operate GENESIS but only interact with modelers may omit this material. Because of the nature of addressing the needs of both planners and

engineers, some material is repeated in the different contexts to allow both groups to achieve understanding of the modeling system.

15. The second function of this report is to serve as an operating manual for GENESIS, including practice in implementing its principal features. Part VI begins the manual portion and concerns the structure and use of the interface consisting of input files and output files. The potential of GENESIS is demonstrated in Part VII through simple examples that show various combinations of capabilities of the modeling system. Part VIII presents a realistic case study that draws on theory and practice developed in Parts V-VII.

16. Appendix A gives a review of the literature dealing with GENESIS and its predecessor, covering model development, tests, case studies, and findings of general interest. Appendix B contains blank input files, which may be photocopied in preparatory work for running GENESIS. Common error messages and suggested recovery procedures are given in Appendix C. Input files for the case study are given in Appendix D. Notation used in this report is listed in Appendix E. Appendix F is an index.

17. The present report documents Version 2 of GENESIS. It is anticipated that additional volumes will provide updates on improvements of GENESIS that lead to significant enhancements and new versions of the shoreline change modeling system. Report 2 in the series is scheduled to be a workbook for power users of GENESIS and will be referred to as the "GENESIS Workbook." The GENESIS Workbook will be a toolbox containing computer routines developed for preparing and analyzing data in conjunction with GENESIS. It will also describe analysis strategies and provide more detailed information on the use of an external wave transformation model with GENESIS than was possible here.

PART II: OVERVIEW OF BEACH CHANGE MODELS

Need for Models of Shoreline Change

18. Shore protection and beach stabilization are major responsibilities in the field of coastal engineering. Beach erosion, accretion, and changes in the offshore bottom topography occur naturally, and engineering in the coastal zone also influences sediment movement along and across the shore, altering the beach plan shape and depth contours. Beach change is controlled by wind, waves, current, water level, nature of the sediment (assumed here to be composed primarily of sand), and its supply. These littoral constituents interact as well as adjust to perturbations introduced by coastal structures, beach fills, and other engineering activities. Most coastal processes and responses are nonlinear and have high variability in space and time. Although it is a challenging problem to predict the course of beach change, such estimations must be made to design and maintain shore-protection projects.

19. In the planning of projects located in the nearshore zone, prediction of beach evolution with numerical models has proven to be a powerful technique to assist in the selection of the most appropriate design. Models provide a framework for developing problem formulation and solution statements, for organizing the collection and analysis of data, and, importantly, for efficiently evaluating alternative designs and optimizing the selected design. It should be cautioned that models are tools that can be misused and their correct or incorrect results misinterpreted. Ultimately, it is the modeler who has responsibility for results and actions taken, not the model.

20. Given the complexity of beach processes, efforts to predict shoreline change should be firmly grounded on coastal experience, i.e., adaptation and extrapolation from other projects on coasts similar to the target site. However, prediction through coastal experience alone, without the support of a numerical model, suffers limitations.

- a. It relies on the judgment of specialists familiar with the coast and on experience with or histories of previous projects, which may be limited, inapplicable, or anachronistic. Also, conflicting opinions can lead to confusion and ambiguity.

- b. It is subjective and does not readily allow comparison of alternative designs with quantifiable evaluations of relative advantages and disadvantages.
- c. It is not systematic in that it may not include all pertinent factors in an equally weighted manner.
- d. It does not allow for estimation of the functioning of novel or complex designs. This is particularly true if the project is built in stages separated by long time intervals.
- e. It cannot account for the time history of sand transport as produced, for example, by natural variations in wave climate, modifications in coastal structures, and modification in the beach, as through beach nourishment or sand mining.
- f. It does not provide a methodology or criteria to optimize project design.

21. In summary, complete reliance on coastal experience means that project decisions are based mainly on the judgment of the engineer and planner without recourse to external and alternative evaluation procedures. Although the project engineer must assume full responsibility, use of GENESIS in applicable situations introduces a means to make objective assessments and promotes collective analysis of the results.

Shoreline Change Model and Capabilities

22. Over the past decade, a powerful class of numerical models has been developed that is applicable to the prediction of beach change. These models are referred to as shoreline change or shoreline response models because they simulate changes in position of the shoreline in response to wave action and boundary conditions. The framework for shoreline change models was established by Pelnard-Considere (1956), who set down the basic assumptions, derived a mathematical model, and verified the solution of shoreline change at a groin with laboratory experiments. Under certain assumptions (to be discussed) that are valid for many conditions encountered on sandy coasts, these models can calculate the response of the shoreline to wave action for a wide variety of engineering situations. Shoreline change models have been applied in numerous projects, and their usefulness as a planning and design tool has been confirmed.

23. The shoreline change model predicts shoreline position changes that occur over a period from several months to several years. The model is best suited to situations where there is a systematic trend of long-term change in shoreline position, such as shoreline regression downdrift of a groin or jetty and advance of the shoreline behind a detached breakwater. The dominant cause of shoreline change in the model is spatial change in the longshore sand transport rate along the coast. Cross-shore transport effects such as storm-induced erosion and cyclical movement of shoreline position as associated with seasonal variations in wave climate are assumed to cancel over a long simulation period. Cross-shore effects are implicitly included in the model if measured shoreline positions are used in verification of predictions.

24. Figures 2a-c show an example of shoreline change that is well suited for modeling. The site is Oarai Beach, located about 180 km north of Tokyo on the Pacific Ocean coast of Japan. A 500-m-long groin was constructed to protect a fishing harbor from infiltration by sand carried by the longshore current. Because of the availability of extensive wave, shoreline position, and other needed data, this beach proved ideal for development and refinement of a predecessor shoreline change model of GENESIS (Kraus 1981; Kraus and Harikai 1983; Kraus, Hanson, and Harikai 1984; Hanson and Kraus 1986b; Kraus 1988a,b,c,d). Figures 2a and 2b show that the shoreline had a clear tendency to advance on the updrift side of the long groin independent of season if the interval between compared surveys is taken to be 1 year. Figure 2c gives a plot of shoreline positions surveyed during each season of 1 year. The tendency of the shoreline to advance is partially obscured because the relatively short interval of 3 months includes the effects of individual storms and other seasonal changes in wave climate, such as change in predominant wave direction, on shoreline position.

Duration and Extent of Simulation

25. The length of the time that can be modeled depends on the wave and sand transport conditions, accuracy of the boundary conditions, characteristics of the project, and whether the beach is near or far from equilibrium.

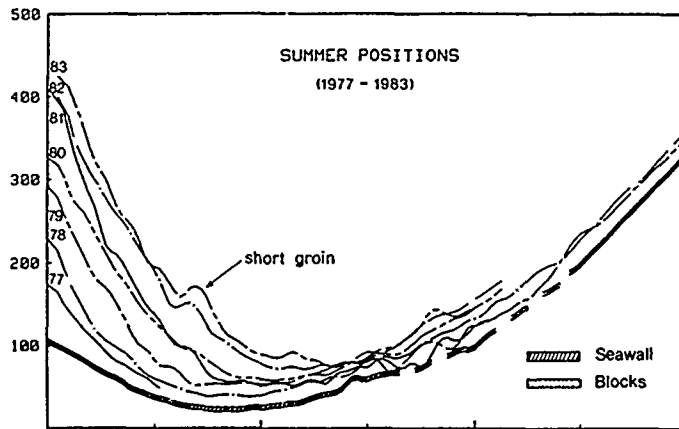

a. Summer shoreline positions

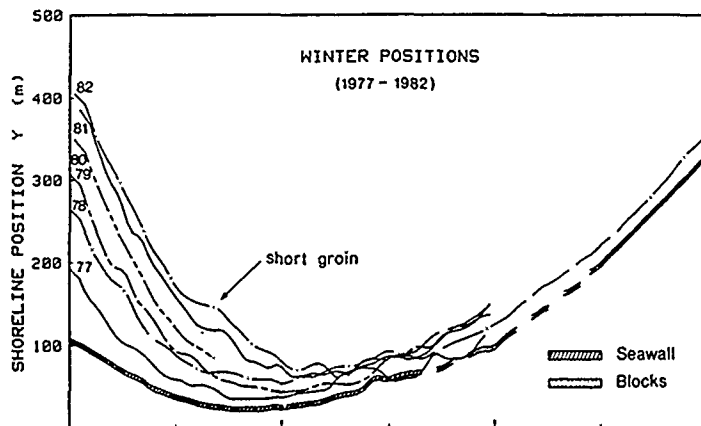

b. Winter shoreline positions

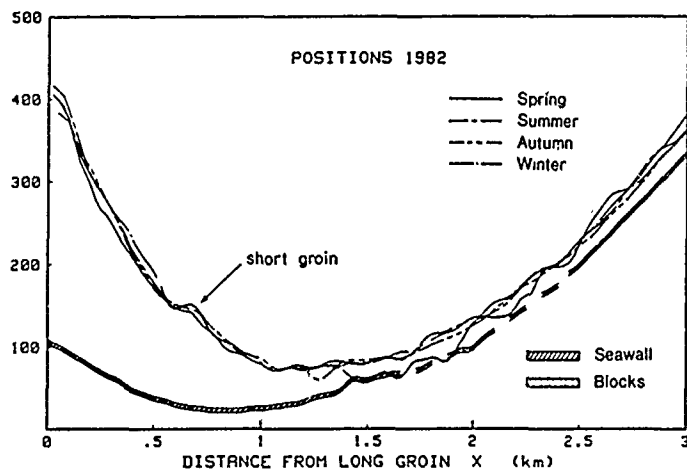

c. Shoreline positions in four seasons

Figure 2. Shoreline change near a long groin

Immediately after completion of a project, the beach is far from equilibrium, and changes resulting from longshore sand transport usually dominate over storm and seasonal changes, with the possible exception of a beach fill. Shoreline change calculated over a short interval will probably be reliable in such a case. As the beach approaches equilibrium with the project, the simulation interval must extend to a number of years. Stated differently, the shoreline change model best calculates shoreline movement in transition from one equilibrium state to another.

26. The spatial extent of a target region ranges from the single project scale of hundreds of meters to the regional scale of tens of kilometers. The modeled longshore extent will depend on the physical dimensions of the project and boundary conditions controlling the sand transport. Dimensions of the project are typically at a local scale, whereas placement of appropriate model boundary conditions may require extension to a more regional scale. Evaluation of possible effects of the project on neighboring beaches may also dictate extension of the spatial range of the simulation. Shoreline change numerical models require modest computer resources and are well suited for regional scale engineering studies.

27. Shoreline change models are designed to describe long-term trends of the beach plan shape in the course of its approach to an equilibrium form. This change is usually caused by a notable perturbation, for example, by jetties constructed at a harbor or inlet. Shoreline change models are not applicable to simulating a randomly fluctuating beach system in which no trend in shoreline position is evident. In particular, GENESIS is not applicable to calculating shoreline change in the following situations which involve beach change unrelated to coastal structures, boundary conditions, or spatial differences in wave-induced longshore sand transport: beach change inside inlets or in areas dominated by tidal flow; beach change produced by wind-generated currents; storm-induced beach erosion in which cross-shore sediment transport processes are dominant; and scour at structures. Table 1 gives a summary of major capabilities and limitations of Version 2 of GENESIS, which will be discussed in succeeding chapters.

Table 1

Major Capabilities and Limitations of GENESIS Version 2

Capabilities

Almost arbitrary numbers and combinations of groins, jetties, detached breakwaters, beach fills, and seawalls
Compound structures such as T-shaped, Y-shaped, and spur groins
Bypassing of sand around and transmission through groins and jetties
Diffraction at detached breakwaters, jetties, and groins
Coverage of wide spatial extent
Offshore input waves of arbitrary height, period, and direction
Multiple wave trains (as from independent wave generation sources)
Sand transport due to oblique wave incidence and longshore gradient in height
Wave transmission at detached breakwaters

Limitations

No wave reflection from structures
No tombolo development (shoreline cannot touch a detached breakwater)
Minor restrictions on placement, shape, and orientation of structures
No direct provision for changing tide level
Basic limitations of shoreline change modeling theory

Comparison of Beach Change Models

28. In this section, capabilities of the shoreline change model are compared with those of other types of beach change models. Figure 3 extends and updates the classification scheme of Kraus (1983, 1989), developed for comparing the capabilities of beach evolution models by their spatial and temporal domains of applicability. Ranges of model domains were estimated by consideration of model accuracy and computation costs. These ranges will expand as knowledge of coastal sediment processes improves, experience is gained in model usage, wave and shoreline position data become available, numerical schemes become optimized, and computer costs decrease.

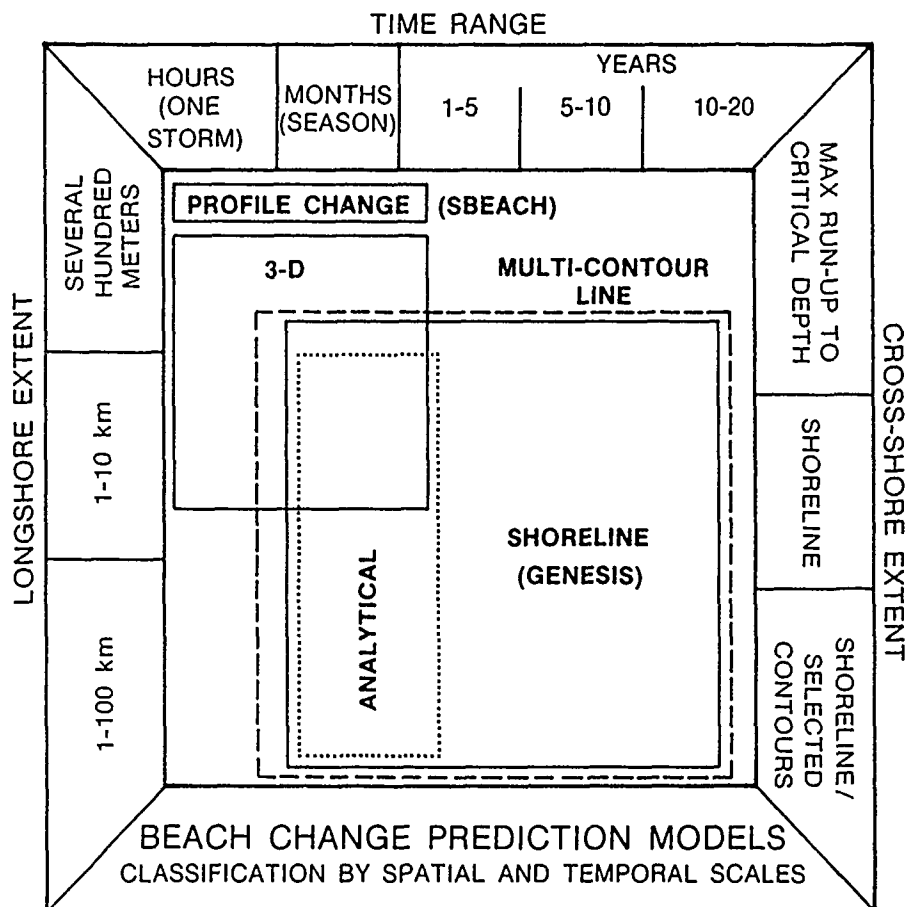

Figure 3. Comparison of beach change models

Analytical models of shoreline change

29. Analytical models are closed-form mathematical solutions of a simplified differential equation for shoreline change. Because of the many idealizations needed to obtain a closed-form solution, particularly the requirement of constant waves in space and time, analytical models are too crude for use in planning or design, except possibly in the preliminary stage of project scoping. Analytical solutions serve mainly as a means to identify characteristic trends in shoreline change through time and to investigate basic dependencies of the change on the incident waves and the initial and boundary conditions. Larson, Hanson, and Kraus (1987) have given a comprehensive survey of more than 25 new and previously derived analytical solutions of the shoreline change equation.

Profile erosion models

30. Principal uses of profile erosion models are prediction of beach change on the upper beach profile produced by storms (Kriebel 1982; Kriebel and Dean 1985; Larson 1988; Larson, Kraus, and Sunamura 1988; Larson and Kraus 1989b; Larson, Kraus, and Byrnes, in preparation) and initial adjustment of beach fills to wave action (Kraus and Larson 1988, Larson and Kraus 1989a). This type of model is simplified by omitting longshore transport processes; i.e., constancy in longshore processes is assumed so that only one profile at a time along the coast is treated. In principle, the profile change and shoreline change models could be used in combination to predict both long- and short-term changes in shoreline position.

Shoreline change model

31. The shoreline change numerical model, the subject of this report, is a generalization of analytical shoreline change models. It enables calculation of the evolution of the shoreline under a wide range of beach, coastal structure, wave, and initial and boundary conditions, which may vary in space and time, as appropriate. Despite the assumption of constancy of beach profile shape alongshore, the shoreline change numerical model has proved to be robust in predictions and provides a general solution of the equation governing shoreline change (described in Part V). Because the profile shape is assumed to remain constant, in principle, landward and seaward movement of any contour could be used in the modeling to represent beach position change. Thus, this type of model is sometimes referred to as a "one-contour line" model or, simply, "one-line" model. Since the mean shoreline position (zero-depth contour) or similar datum is conveniently measured, the representative contour line is taken to be the shoreline. Longshore sand transport together with lateral boundary conditions on each of the two ends of the model grid are the dominant causes of beach change in the shoreline change model. Sources of sediment, such as beach fills and river discharges, as well as sediment sinks, such as inlets and sand mining, can be accounted for in a phenomenological manner. From this perspective, the shoreline change numerical model provides an automated means to perform a time-dependent sediment budget analysis.

Schematic three-dimensional (3-D) models

32. Three-dimensional beach change models describe bottom elevation changes, which can vary in both horizontal (cross-shore and longshore) directions. Therefore, the fundamental assumptions of constant profile shape used in shoreline change models and constant longshore transport in profile erosion models are removed. Although 3-D beach change models represent the ultimate goal of deterministic calculation of sediment transport and beach change, achievement of this goal is limited by the capability to predict wave climates and sediment transport rates. Therefore, simplifying assumptions are made in schematic 3-D models, for example, to restrict the shape of the profile or to calculate global rather than point transport rates. Perlin and Dean (1978) extended the "two-line model" of Bakker (1968) to an n-line model in which depths were restricted to monotonically decrease with distance offshore for any particular profile. Larson, Kraus, and Hanson (in preparation) treated longshore and cross-shore transport independently in an iterative process and allowed for nonmonotonic depth change, i.e., formation of bars and berms. Schematized 3-D beach change models have not yet reached the stage of wide application; they are limited in capabilities because of their complexity and require considerable computational resources and expertise to operate. This class of model will probably be the next to be introduced into engineering practice.

Fully 3-D models

33. Fully 3-D beach change models represent the state of the art of research and are not widely available for application. Waves, currents (wave-induced and/or tidal), sediment transport, and changes in bottom elevation are calculated point by point in small areas defined by a horizontal grid placed over the region of interest. Use of these models requires special expertise and powerful computers. Only limited applications have been made on large and well-funded projects (for example, Vemulakonda et al. 1988, Watanabe 1988). Because fully 3-D beach change models are used in attempts to simulate local characteristics of waves, currents, and sediment transport, they require extensive verification and sensitivity analyses.

Conclusions

34. The shoreline change numerical model is the only general purpose engineering model presently available for wide application in simulating long-term evolution of the beach plan shape. This type of model provides a framework for performing a time-dependent sediment budget analysis under a wide range of situations encountered in shore-protection projects and requires only generally available or estimated input data. With the advent of GENESIS, the potential of the shoreline change model has reached a stage where it can be operated without expertise in numerical modeling. Numerous refinements can be expected as the model is tested and adapted to include other phenomena and engineering activities responsible for causing long-term beach change.

PART III: SHORELINE CHANGE MODELING AS A TOOL IN THE PLANNING PROCESS

Elements of the Planning Process

35. This chapter discusses the role of shoreline change modeling in the overall process of planning, designing, constructing, and evaluating the performance of a shore-protection project. The material addresses the question of how a shoreline change model may be used in the decision-making process of coastal management and shore protection (Kraus 1989). The purpose of such planning is to determine the most effective socioeconomic engineering solution to a shore-protection problem.

36. The planning process broadly consists of the following steps:

- a. Formulate problem statement, identify constraints, and develop criteria for judging the performance or intent of the project.
- b. Assemble and analyze relevant data.
- c. Determine project alternatives.
- d. Evaluate alternatives. (Return to Step a, as necessary.)
- e. Select and optimize project design.
- f. Construct the project.
- g. Monitor the project.
- h. Evaluate project according to Step a and report the results.

These steps and their interrelation are shown diagrammatically in Figure 4. Stages in the planning process where modeling can take an active role are designated by the word "model."

"Plan regional, engineer local"

37. The problem statement and judgment criteria will usually encompass diverse factors, requiring comprehensive planning as opposed to single-project planning. It is essential to imbed the functioning of a project within the regional coastal processes. Question 1: Will regional processes (for example, a wide-area tendency to erode) affect the long-term success of a project; i.e., will the project contradict nature? Question 2: Will the project have a detrimental impact beyond the immediate area, or will it have a beneficial effect, such as the downdrift benefit of a beach fill? These types of considerations lead to the approach "plan regional, engineer local."

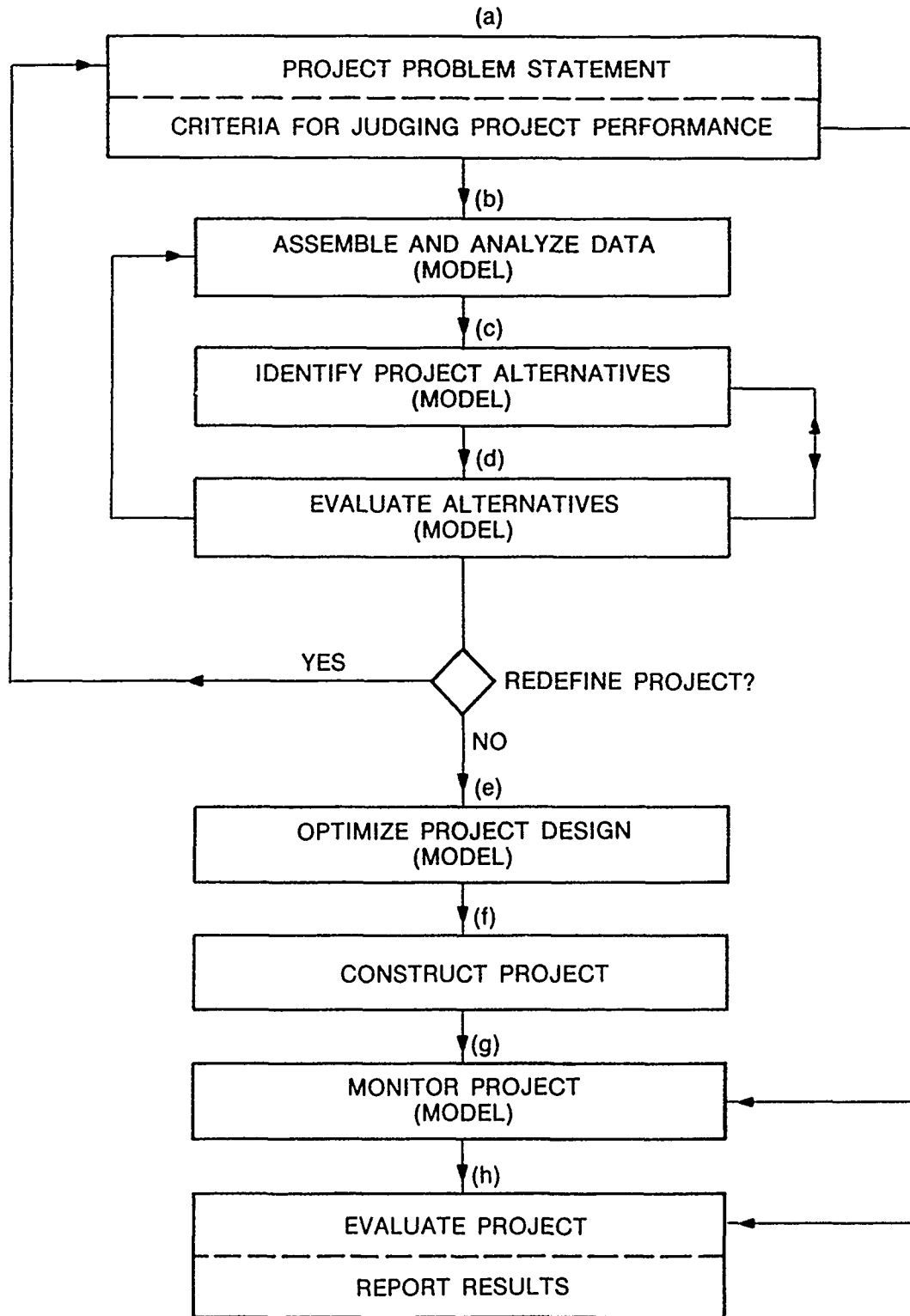

Figure 4. Major steps in project planning and execution

Step a

38. A clear problem statement and criteria for judging the project's functioning must be formulated to determine objectively its degree of success or failure. The problem statement and judgment criteria should be explicit. Otherwise, the passage of time between project planning and performance evaluation may obscure the original purpose, and the functioning or intent of the project may be evaluated out of context.

39. For example, suppose a section of road along a coast is threatened by erosion. One possible problem statement is that erosion is endangering a road between points A and B. A criterion for judging the performance of the project would be to mitigate or halt the erosion for less than X dollars in initial construction and less than Y dollars in annual maintenance. Suppose also that a revetment is selected as the optimal solution and is constructed and maintained within budget. Also, monitoring shows that the project performed as intended in protecting the road. The project has satisfied the original objectives under single-project planning. However, if after construction it was determined that the beach downdrift of the project had eroded because of sand deprivation (caused, for example, by impoundment of sand by the structure and loss of sand to the system through encasement by the revetment), it might be judged that the project was a failure. A similar project might have as its comprehensive planning problem statement protection of the road and mitigation of anticipated erosion at the downdrift beach. This would probably lead to a different solution, for example, a revetment to protect the road fronted by a feeder beach to nourish the downdrift beach. It is important to distinguish between failures in the planning process and failures in projects themselves if lessons are to be learned from experience.

Step b

40. All relevant data should be assembled and analyzed with a view of both defining the problem statement and deciding on a solution approach. In the example given above, an evaluation of information on shoreline change and the predominant direction of longshore sand transport would have led to a more comprehensive problem statement.

Steps c and d

41. Development of a project from the point of problem identification through construction and performance evaluation involves consideration of five general issues:

- a. Technical feasibility.
- b. Economic justification.
- c. Political feasibility.
- d. Social acceptability.
- e. Legal permissibility.

Technical feasibility concerns the magnitude of the wave, current, and sediment transport processes at the site; availability of construction materials; potential constraints on project design because of external factors; limitations on access to the site; and experience and knowledge of the staff. Economic feasibility concerns the potential benefits of the project and is usually the major justification of a project. Funding for project planning and design staff, construction, maintenance, and monitoring also enter into the economic justification. Economic justification, political feasibility, social acceptability, and legal permissibility are closely related, since local, state, and Federal governments are usually partners in the funding and permitting of a project.

42. Evaluation of alternatives involves simultaneous assessments of technical and economic feasibility to arrive at a cost-beneficial design. During the detailed investigation of alternatives and use of the data base developed at Step b, it may become apparent that the original problem statement and judgment criteria for the project need to be refined. For example, project planning may be initiated to satisfy a local need, but later evolve to consider the primary (site-specific) problem and associated secondary effects on a regional scale.

Step e

43. Once the best alternative is selected, it is necessary to optimize the design so that the greatest benefit is obtained for the least cost. As an example, consider a hypothetical shore-protection project at a state park which has a beach that is used only lightly for bathing but attracts many beach walkers and campers. Alternatives identified at Step c are beach fill,

groins, detached breakwaters, or combinations of these elements. After analysis of park usage, it is decided that a beach fill is not required and, in any case, could not be maintained because of limited anticipated funding. The groin alternative is eliminated because a large cross-shore component of transport exists due to persistent short-period waves. A system of segmented detached breakwaters combined with a moderate initial fill placed at critically eroded sections best meets project objectives and is selected for implementation. At Step e of the planning process, the detached breakwater system would be optimized by determining the distance for placement offshore, orientation, gap width between breakwaters, crown height and structure thickness, construction material, etc., as well as the amount of fill required. Potential impacts of the project on beachfront properties located beyond the borders of the park would also be considered.

Steps f and g

44. After the project is constructed, it should be monitored to ascertain that the final design was properly implemented (and to record deviations from the design) and to evaluate its performance. The monitoring plan should be formulated to answer the question of whether the project achieved its purpose according to the criteria developed at Step a. By designing the monitoring program to address the problem statement at Step a, both a productive and economical monitoring plan can be developed. Results of the project should be published and the processed data archived for use in future assessments and research and by other projects.

Role of Shoreline Change Modeling

45. Shoreline change modeling is closely associated with and can greatly aid the planning process described in the preceding section. This section discusses those relations.

Step b

46. Data requirements of the shoreline change model (discussed in detail in Part IV) include a wide range of coastal process- and project-related information. Within the framework of shoreline change modeling, guidelines are available for collecting, reducing, and analyzing the data in a

systematic manner (as given here and in the GENESIS Workbook). Most physical data needed for evaluating and interpreting shoreline and beach evolution processes in a broad sense are used in the shoreline change modeling methodology. Certain other data may be lacking in particular applications having unique requirements, so that coastal experience and overall project planning should not be subverted by complete dependence on shoreline change modeling requirements.

47. Geological and regional factors such as earthquakes, subsidence, and structure of the sea bottom substrata may indirectly enter into shoreline change modeling. For example, interpretation of historic shoreline position change must account for subsidence if it has occurred. Environmental factors such as water circulation and quality (temperature, salinity, sediment concentration, etc.), as well as biological factors, may also have to be considered. For example, although GENESIS can model the movement of beach-fill material placed at arbitrary locations and times along the beach, the breeding habits of sea turtles and birds may restrict the season and/or location of the fill and constrain the project design and construction schedule. In summary, satisfaction of the data requirements of the shoreline change model provides an organized and comprehensive first step in assembling the necessary data for project design.

Steps c-e

48. Provided that shoreline change at the site can be modeled, GENESIS is well suited for quantitative and systematic evaluation of alternatives and for optimization of the final plan. As an example, Hanson and Kraus (1986a) simulated beach change for nine hypothetical combinations of plans to mitigate erosion at a recreational beach. The without-project ("do nothing") alternative and several shore-protection schemes were evaluated for groins of various sizes and spacings, beach fills of various quantities, and a single, long detached breakwater. Technical criteria for judging the solution involved two factors, protection of the eroding beach and minimization of the quantity of sand transported downcoast that would enter the navigation channel of a fishing harbor. For each alternative, shoreline change modeling allowed

compilation of a matrix of beach change volumes at various sections of the coast by which the technical solutions could be ranked. Economic considerations were then used to arrive at the most feasible project plan.

Step g

49. In addition to aiding in the evaluation and optimization of project designs, shoreline response modeling can provide guidance for preparing a monitoring plan (Step g). Regions of anticipated maximum and minimum shoreline change or sensitivity can be identified and the monitoring plan structured to provide data in these important regions. Initial estimates of the monitoring schedule (frequency of measurements) and density or spacing of measurement points can also be made by reference to model predictions.

Conclusions

50. Because of their great power and generality, shoreline change numerical simulation models such as GENESIS provide a framework for developing shore-protection problem and solution statements, for organizing the collection and analysis of data, and, most importantly, for evaluating alternative designs and optimizing the selected design. Numerical models of beach evolution extend the coastal experience of specialists and introduce a systematic and comprehensive project management methodology to the local engineering or planning office.

51. This chapter has attempted to demonstrate the utility and benefits of numerical modeling of coastal processes to the coastal planning and management community. Although emphasis was on numerical modeling and beach processes, it should be recognized that planning and design of a shore-protection project will involve a wide range of techniques and tools.

PART IV: PROJECT EVALUATION AND USES OF GENESIS

Scoping Mode and Design Mode

52. Depending on the stage of the project study, amount and quality of data available to operate the modeling system, and level of modeling effort required, GENESIS can be applied at two different levels, the scoping mode and the design mode. The scoping mode uses minimal data input and might be employed in a reconnaissance study to better define the problem and to identify potential project alternatives. The design mode enters in feasibility or design studies for which a substantial modeling effort is required.

53. The scoping mode requires the minimum amount of data needed to characterize a project. A scoping mode application is a schematic study with such simplifications made as initially straight shoreline and idealized wave conditions representing, for example, predominant seasonal trends in wave height, direction, and period. In the scoping mode, the model is an exploratory tool for obtaining estimates of relative trends in shoreline change for different plans. Results from the different alternatives may then be qualitatively compared without regard to absolute magnitudes. The scoping mode is a first attempt at project definition and the investigative stage of solution.

54. In the design mode, the objective is to obtain correct shoreline change as well as magnitude and direction of the longshore sand transport rate. The design mode of operation proceeds systematically through data collection, model setup, calibration and verification, and then to intensive work to evaluate alternative designs, finally being used to optimize the final project design. In the design mode, all possible data and ingenuity are brought to bear in the modeling.

55. The scoping and design modes serve distinct purposes. Similar to the choice of outpatient treatment at a clinic or full treatment at a hospital, certain functions may overlap, but the mode of solution should match the need of the problem. Scoping with GENESIS is made under highly simplified conditions; it definitely should not be considered as a substitute for a design mode application of the model, and scoping results should not be represented as such.

Input Data

56. Identification and evaluation of alternative solutions can begin once a problem statement has been formulated. Development of a solution and use of GENESIS are based on physical data and quantification of the processes involved. The necessity of satisfying data requirements prior to application of GENESIS systemizes the procedure of data collection and analysis and is a benefit to all aspects of the project.

57. Various types of data are involved in project evaluation: legal, financial, cultural, environmental, and physical. Here only physical data are considered. Physical data are required for two purposes:

- a. To obtain background information for making a general and integrated assessment of coastal processes at the site and of the geographic region.
- b. To calibrate, verify, and make predictions with GENESIS.

Complete guidance covering item a cannot be given, as each project will have unique characteristics. Coastal engineering and geological experience must be relied upon to determine special factors, physical and environmental, which may affect project design and performance. The present section deals with item b, data necessary to run GENESIS. However, since the data sets needed to run GENESIS encompass many aspects of coastal processes, clues pointing toward site-specific data requirements can be expected.

58. The first technical step in a modeling task is to establish a shoreline coordinate system. The regional trend of the coast is determined from a wide-scale chart, whereas the trend of the local shoreline is determined from a small-scale chart. The regional trend is used to identify the orientation of offshore contours for wave refraction modeling, whereas shoreline positions, structure configurations, and other project-specific information are referenced to the small-scale chart.

59. A decision is made on the trend of the shoreline, and a longshore (x) axis is drawn parallel to the trend. A shore-normal (y) axis is then drawn pointing offshore to create a right-hand system, as shown in Figure 5. Based on the availability and quality of data, extent of the modeled area, detail desired, and the level of effort, the grid spacing is specified. Typical longshore spacing is 25, 50, or 100 m if working in the metric system,

and 50, 100, 200, or 500 ft* if working in American customary units. GENESIS requires no cross-shore grid spacing. The coordinate system and grid are established early in the project, as all geographic information (shoreline positions; locations of structures, beach fills, and river mouths; bathymetry; wave input; etc.) must be referenced to the same coordinate system and datum and this information may be prepared by different individuals.

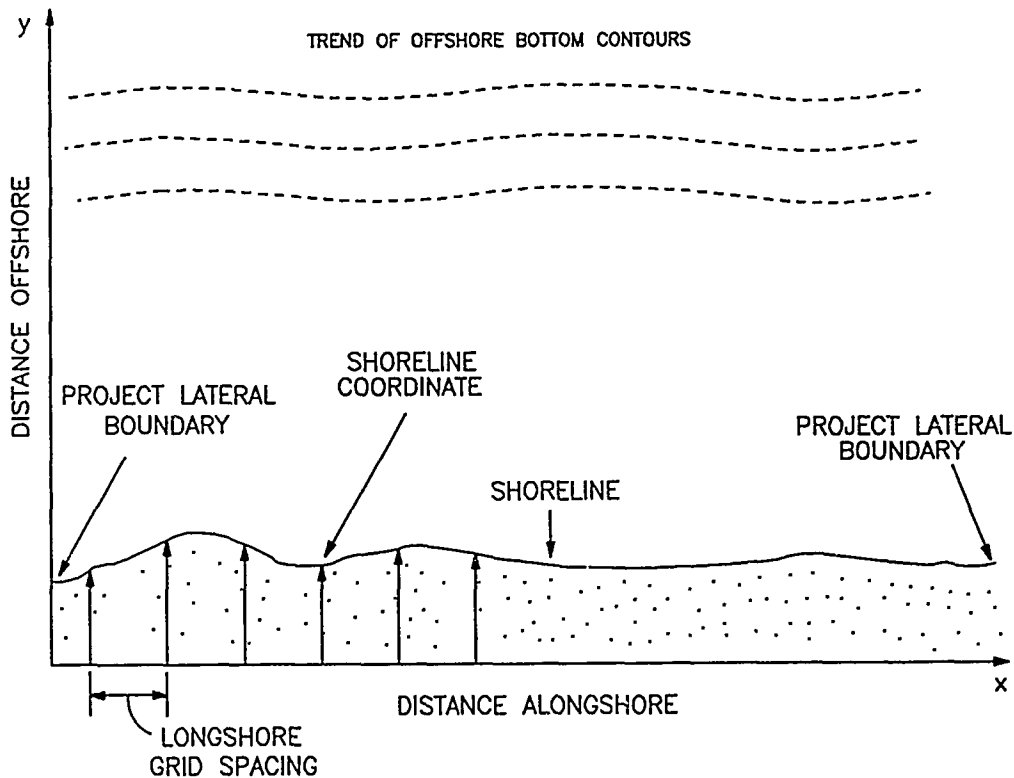

Figure 5. Model coordinate system

60. Discussion of input data requirements will center on Table 2 (see also, Tanaka 1988). This table can also be used at the start of project planning as a checklist for needed data. Only a small portion of the data listed are used directly by GENESIS. The minimal information required is:

- a. Shoreline position.
- b. Waves.

* A table of factors for converting non-SI units of measurement to SI (metric) units is presented on page 8.

- c. Structure configurations and other engineering activities.
- d. Beach profiles.
- e. Boundary conditions.

The other data listed in Table 2 are needed for interpretation of sediment transport processes and beach change. For example, coastal subsidence or an earthquake might produce an apparent trend in shoreline recession unrelated to longshore sand transport or boundary conditions.

Shoreline position

61. Shoreline position data can be obtained from shoreline surveys, beach profile surveys, aerial photographs, maps, and nautical charts. Shoreline positions should be referenced to the longshore baseline and values interpolated to longshore grid points so that shoreline positions calculated with GENESIS can be easily compared. The terminology "shoreline position" usually refers to the zero-depth contour with respect to a certain datum, for example, mean sea level (MSL) or to mean lower low water (MLLW). All shoreline position and bathymetry data for wave refraction modeling should be referenced to the same datum.

62. Plots of shoreline positions may reveal errors in the data as well as trends in shoreline change. As much as possible, the two surveys defining the calibration and verification intervals should be in the same season to minimize the effect of the seasonal cyclical displacement of the shoreline.

Offshore waves

63. It is rare to have adequate wave gage data for a modeling effort. If gage data are not available, hindcasts can be used. The Wave Information Study (WIS) (e.g., Jensen 1983a,b; Jensen, Hubertz, and Payne 1989) provides hindcast estimates of height, period, and direction at intervals along all continental US coasts. Gravens (1988) discusses a methodology for use of WIS data in calculation of potential longshore sand transport rates.

64. At the lowest level of effort, statistical summaries of hindcasts can be used. In typical design mode shoreline change modeling projects performed at CERC, offshore wave data are input at 6-hr intervals over the simulation period. Actual wave height in the time series is used, but wave period and direction are grouped into approximately 50 to 100 categories or

period-direction bands to limit the number of distinct wave transformation calculations that must be made. This topic is discussed further in Part V.

Table 2
Data Required for Shoreline Change Modeling

<u>Type of Data</u>	<u>Comments</u>
Shoreline position	Shoreline position at regularly spaced intervals alongshore by which the historic trend of beach change can be determined.
Offshore waves	Time series or, at a minimum, statistical summaries of offshore wave height, period, and direction.
Beach profiles and offshore bathymetry	Profiles to determine the average shape of the beach. Bathymetry for transforming offshore wave characteristics to values in the nearshore.
Structures and other engineering activities	Location, configuration, and construction schedule of engineering structures (groins, jetties, detached breakwaters, harbor and port breakwaters, seawalls, etc.). Structure porosity, reflection, and transmission. Location, volume, and schedule of beach fills, dredging, and sand mining. Sand bypassing rates around jetties and breakwaters.
Regional transport	Identification of littoral cells and transport paths. Sediment budget. Locations of inlets. Wind-blown sand transport.
Regional geology	Sources and sinks of sediment (river discharges, cliff erosion, submarine canyons, etc.). Sedimentary structure. Grain size distribution (native and of beach fill). Regional trends in shoreline movement. Subsidence. Sea level change.
Water level	Tidal range. Tidal and other datums.
Extreme events	Large storms (waves, surge, failure of structures, etc.). Inlet opening or closing. Earthquakes.
Other	Wave shadowing by large land masses. Strong coastal currents. Ice. Water runoff.

65. In a scoping mode, or if the offshore contours are parallel to the trend of the shoreline and the extent of the project to be modeled is small (for example, shoreline change at a single detached breakwater), the simple wave transformation routine (internal model) in GENESIS can be used to refract, shoal, and diffract waves. GENESIS will transform the waves from the depth of the offshore gage or hindcast point and produce the pattern of breaking waves alongshore for calculating the longshore sand transport rate.

66. If offshore contours are irregular or the project is of wide extent, a specialized wave transformation program must be used to propagate the waves from offshore to nearshore for use by GENESIS. Any wave model can be used to provide the required information. At CERC, the model RCPWAVE (Regional Coastal Processes WAVE model) (Ebersole, Cialone, and Prater 1986) is used to supply the needed nearshore wave information.

67. Shoreline change is sensitive to wave direction, and this quantity is the most difficult to estimate. If information on wave direction is not available, wind direction from a nearby meteorological station, buoy, Coast Guard station, or airport may be useful, as well as consideration of possible fetches. The effects of the coastal boundary layer and daily and seasonal trends in wind speed, gustiness, and direction should be taken into account.

68. The wave input interval (time step), statistics of the waves, and the period to be covered must also be determined. For shoreline change model calibration and verification, either hindcast data or the actual wave record occurring over the simulation interval should be used, if available. In simulations involving long periods and wide spatial extent, it may be impractical to handle a wave data file covering the full simulation period. Instead, a shorter wave data file can be used and repeated, a capability provided by GENESIS. The shorter record is fabricated by comparing statistics of the total available wave data set (gage or hindcast) by year, season, and month. Typical quantities that should be preserved are average significant wave height and period, maxima of these quantities, average wave direction, and occurrence of storms. For example, a 5-year record might be composed of 1 year of more frequent storms (but not the extreme year as that would not be representative), a year of relatively low waves, and 3 years judged to be "typical."

Bathymetry and profiles

69. If a wave refraction model is used, hydrographic charts are needed to digitize the bathymetry onto the numerical grid. For users with sufficient computer hardware and related capabilities, bathymetric data for US coasts may be obtained on magnetic media from the National Oceanic and Atmospheric Administration (NOAA) and then interpolated to the grid. The nearshore information from bathymetric charts can be compared with available beach profile surveys. Profile surveys often extend to a nominal depth of 10 m (30 ft), providing information to supplement the charts. If calibration and verification simulation intervals are in the far past (for example, in the 19th century), bathymetric data from that period should be used, not the present bathymetry. This is especially pertinent if an inlet is included in the wave modeling grid, since ebb shoals can greatly change.

70. Profile data are used to estimate three quantities required to operate GENESIS: the average height of the berm, the depth of closure (seaward limit of significant sediment movement), and the average profile slope.

71. Bathymetric and profile data are also used to establish a general sediment budget, to locate scour at structures, to infer sediment paths and flow channels, to identify local areas of deposition and erosion, and to qualitatively estimate and distinguish cross-shore transport and longshore transport effects at structures in some situations.

Structures and other engineering activities

72. Structures and other engineering activities, such as placement of beach fill, must be correctly located on the grid both in space and time. Procedures for accomplishing this are described in Parts VI and VII. Also, GENESIS allows representation of changes in structures through time as, for example, extension of a breakwater, construction of a groin field during the simulation interval, or multiple placements of beach fill. Therefore, in data collection and project planning, the locations, configurations, and times (and volumes in the case of beach fills, dredging, and sand mining) must be assembled.

73. Other types of data may be required in certain situations. Some of these items are difficult to quantify, such as permeability factors for groins and transmission factors for detached breakwaters; nevertheless, estimates must be made. Final values of these ambiguous quantities are usually determined in the model verification process. In these situations, special care must be given to check inferences against field data on shoreline change at the site.

Regional sediment transport

74. Sediment transport and shoreline change at the site should be interpreted within a regional context, as there may be a "far field" effect on the project from processes quite distant from it and vice versa. If possible, the project is placed within the context of a littoral cell, which is a coastal area defined by known or well-estimated sediment fluxes at lateral boundaries. Examples of good lateral boundaries are large inlets and entrances, harbor breakwaters and long jetties, and regions that have experienced little shoreline change. A sediment budget is made for the littoral cell (Shore Protection Manual (SPM) 1984, Chapter 4), and this analysis may be repeated in gradual stages of sophistication, leading into a production modeling effort with GENESIS. Such a simple budget analysis might be termed "first-order modeling" and gives an integrated and regional perspective of the dominant processes to serve as guidance in interpreting the more extensive and quantitative results produced by shoreline change models. Information that should be gathered in this task are estimates of direction and amounts of net longshore sediment transport; gross sediment transport; trends in shoreline change; and seasonal variations in waves, currents, sediment transport, and beach change.

Regional geology

75. Collection and analysis of geologic and geomorphic data are linked with the study of regional transport processes in development of the sediment budget. Typical subjects of the regional geology portion of the study include estimation of the effects of inlets, both as sources and as sinks of littoral material; river discharges; special sources of littoral material, such as cliffs; sea level rise and subsidence; and analysis of grain size. The

geologic history of the coast, the when, how, and of what it was formed, also provides important background material.

Water level

76. If the tidal range is large, wave refraction and breaking will vary significantly according to the water level. For micro- and mesotidal coasts, use of either the MSL or MLLW datums (either of which appears on NOAA bathymetric charts) is considered sufficient. If the tide variation is appreciable, refraction simulations with different water levels may be necessary. Water level also plays a role in wave overtopping and transmission through breakwaters, sediment overtopping and bypassing (shoreward and seaward) at groins, and interpretation of shoreline position from aerial photographs.

77. Version 2 of GENESIS does not allow direct representation of tidal change. However, changes in breaking waves as caused by variations in water level can be represented in the wave input.

Extreme events

78. The aim of shoreline modeling is to simulate long-term change in shoreline position; effects of extreme events are assumed to be accounted for in the verification process. An extreme event is a natural process or engineering activity that causes a substantial, perhaps irreversible, change in the shoreline position. Without documentation of such events, interpretation of shoreline change could be mistaken. Examples of extreme events are storms of record that greatly erode the beach and dredging during construction of coastal structures. It is possible that one or more extreme events may have dominated shoreline change over the interval between shoreline surveys. This is particularly likely if the calibration or verification intervals are relatively short and an extreme event is bracketed. It is important to have documentation on extreme events so that shoreline and beach processes can be properly interpreted. If possible, time intervals that span known extreme events (including, for example, beach fills of unspecified volume) should be avoided in the calibration/verification process.

Other

79. Each site or project brings novel problems, and it is rare that standard operating procedure can be completely followed in a shoreline

modeling effort. Coastal experience must be relied upon to identify unique characteristics of the site or a normally minor factor that may, for some reason, occupy a position of prominence in the coastal processes. These types of problems may often be treated by creative exercise of GENESIS's many features, but sometimes special expertise is required to allow a description of unique situations with GENESIS.

Boundary Conditions

80. As discussed further in Parts V, VI, and VII, boundary conditions must be specified at the two lateral ends of the numerical grid. Boundary conditions determine the rate at which sand may enter and leave the modeled area and can have a profound effect on shoreline change.

81. There are situations in which it may be possible to eliminate the influence of boundary conditions by placing the boundaries far from the project so as to have a negligible effect over the simulation interval. For example, if a project is highly localized, such as a single detached breakwater on a straight sandy beach, the boundaries may be placed several project lengths to either side and a condition of no shoreline change imposed, as the breakwater system is expected to modify only the local area and not completely block longshore sediment transport. In more regional applications, representation of the naturally occurring boundary conditions must be addressed as part of the problem.

82. In situations where the boundary conditions are ill-defined (which is the typical situation in applications), it is of great help to monitor the net and gross longshore sand transport rates calculated by GENESIS (Part V) in addition to shoreline change. Boundary conditions control the magnitude of the longshore sand transport rate. GENESIS provides information on the calculated transport rate for comparison to empirically determined rates or to rates that have to be specified by assumption (for example, at a rocky cliff). In many cases, one or both boundaries are an integral part of the project, such as shoreline change at a long jetty or shore-connected harbor breakwater, blockage of longshore transport at an inlet or navigation channel, or termination of the beach at a headland.

83. GENESIS allows representation of two general boundary conditions, termed a "pinned-beach" condition and a "gated" condition. If the position of the shoreline can be assumed to be stationary, this condition defines a pinned beach. A pinned beach boundary is appropriate if the sediment budget is balanced at the boundary segment of the beach, meaning that the input and output volumes of beach material at the boundary are equal on an average annual basis. A pinned beach boundary may also be imposed if the beach is constrained (e.g., by a rocky cliff or seawall), but sediment can still move alongshore and past the boundary area.

84. A gated boundary condition describes the case of some preferential gain or loss of sand at the boundary; in other words, the boundary influences the transport rate. As a simple example, if a jetty is very long, no sand is expected to flow onto or off the grid at that location. As another example, at some inlets sand may move alongshore and off the grid into the navigation channel running through the inlet, but sand cannot move onto the grid from the inlet (except possibly in an extreme wave event). The inlet thus acts as a gate or rectifier of transport, allowing sand to escape from the project reach but not to enter. Specific examples and hands-on experience in prescribing these conditions are given in Part VI.

Variability in Coastal Processes

Problem of variability

85. Waves bring an enormous amount of energy to the coast, and this energy is dissipated through wave breaking, generation of currents, water level changes, movement of sand, turbulence, and heat. Incident waves vary in space and time, and their properties also change as they move over the sea bottom. The beach is composed of sediment particles of various sizes and shapes which move along and across the shore controlled by laws that are not well known. This sediment is transported by complex three-dimensional circulation patterns of various spatial and time scales and degrees of turbulence. The beach and back-beach also exhibit different textural properties that vary alongshore, across-shore, and with time. In light of the profound variability of coastal processes, it is clear that a single answer

obtained with a deterministic simulation model must be viewed as a representative result that has smoothed over a large number of unknown and highly variable conditions.

86. Similarly, in use of a deterministic model in a predictive mode, the factors responsible for beach change (in the case of GENESIS, primarily the waves) are not known. A time series of wave height, period, and direction must be forecast for use in the prediction and can be considered as only one of many possible wave climates that might occur.

Accounting for variability

87. Since there is great variability in the nearshore system, any one prediction of shoreline change cannot be the correct answer. Several studies have been made on wave variability and shoreline change prediction (Kraus and Harikai 1983; Le Méhauté, Wang, and Lu 1983; Kraus, Hanson, and Harikai 1984; Hanson and Kraus 1986a; Hanson 1987; Walton, Liu, and Hands 1988), and some guidance has been developed for use in the prediction process. These references should be consulted to supplement discussion given here.

88. A simple procedure used at CERC to estimate the effect of wave variability is to compute the standard deviation of the wave height and direction in the input wave time series and then adjust values of the input waves through a range defined by these deviations. GENESIS allows adjustment of wave height and direction by user-specified amounts. Wave period is not normally varied, but in certain applications, such as a situation involving waves of long periods or a sea bottom with highly irregular features, the refraction pattern will be particularly sensitive to wave period. Another procedure uses different hindcast time series if such data are available. By varying the input wave height and direction within a physically reasonable range, a series of shoreline change predictions is made within which the actual change is expected to lie. Variation of input parameters is also part of the sensitivity analysis to be performed to obtain some idea of model dependence on empirical parameters, as discussed in a later section.

Calibration and Verification

89. Model calibration refers to the procedure of reproducing with a model the changes in shoreline position that were measured over a certain time interval. Verification refers to the procedure of applying the calibrated model to reproduce changes measured over a time interval different from the calibration interval. The terms "calibration" and "verification" are often referred to as "verification" alone, since verification implies that calibration has been done. Successful verification is taken to indicate that model predictions are independent of the calibration interval (i.e., that the empirical coefficients and boundary conditions remain constant for the coast), but it does not guarantee this independence, and conditions can easily change, which will void the verification process. For example, a boundary condition of unrestricted sand transport (pinned beach) may change to a gated boundary condition after construction of an entrance channel through the beach. The modeler must be aware of significant changes in the physical situation that might invalidate the original verification and require new verification. Also, the available wave data set may better represent the wave climate that existed during some calibration and verification periods than other periods.

90. In practice, data sets sufficiently complete to perform a rigorous calibration and verification procedure are usually lacking. Typically, wave gage data are not available for time intervals between available measured shoreline positions, and unambiguous and complete data on historical shoreline change are often unavailable. This situation increases the number of unknowns in the modeling process and thereby reduces reliability of the calculation. In the absence of hard data, estimates of shoreline change with the model may provide the only source of systematic and quantitative information with which to make planning decisions. In situations where data are lacking, coastal experience and experience with GENESIS must be relied upon to supply reasonable estimates of input parameters and to interpret calculated results.

91. Model predictions are readily compared by graphical means. Plots are made of calculated and measured shoreline positions, normally at exaggerated vertical scales (shoreline position coordinate). Shoreline positions can also be manipulated mathematically to determine in a least-squares sense,

for example, the combination of parameters producing the best match of calculated and measured values. This provides an objective measure of goodness of fit, whereas visual inspection is somewhat subjective. However, a mathematically based criterion should always be checked by visual inspection of shoreline position plots as cancellation of errors is prone to happen for sinuous shorelines and may produce a misleading measure of goodness of fit.

Sensitivity Testing

92. Sensitivity testing refers to the process of examining changes in the output of a model resulting from intentional changes in the input. If large variations in model predictions are produced by small changes in the input, calculated results will depend greatly on the quality of the verification, which is usually in some degree of doubt in practical applications. A second reason for conducting sensitivity tests concerns the natural variability existing in the nearshore system, as discussed in a previous section. No single model prediction can be expected to provide the correct answer, and a range of predictions should be made and judgment exercised to select the most probable or reasonable result. If the model is oversensitive to small changes in input values, the range of predictions will be too broad and, in essence, provide no information. Experience has shown that GENESIS is usually insensitive to small changes in parameter values. Nevertheless, sensitivity testing should always be done.

Interpretation of Results

93. Results should always be checked for general reasonability. In this regard, an overview of regional and local coastal processes and the sediment budget calculation or first-order modeling discussed previously should be employed to judge model results. For example, is the overall trend of the calculated shoreline position correct and not just the dominant feature? Do the magnitude and direction of the calculated longshore sand transport rate agree with independent estimates? Experience gained in the verification, sensitivity analysis, and modeling of alternative plans will

help uncover erroneous or misleading results. Plots of computed shoreline positions reveal obvious modeling mistakes, whereas more subtle errors of either the model or modeler can be found in the sensitivity analysis through understanding of basic dependencies of shoreline change on the wave input and boundary conditions.

94. Shoreline change is governed by nonlinear processes, many of which are represented in GENESIS. Complex beach configurations and time-dependent wave input will produce results that cannot be extrapolated from experience. However, as much as possible, experience should be called upon to evaluate the correctness of results and to comprehend the trends in shoreline change produced.

95. Finally, the user must maintain a certain distance from model results. It should be remembered that obliquely incident waves are not responsible for all longshore sand transport and shoreline change. Potential errors also enter the hindcast of the incident waves, in representing an irregular wave field by monochromatic waves and, sometimes, through undocumented human activities and extreme wave events that have modified the beach. The probable range in variability of coastal processes must also be considered when interpreting model results.

PART V: THEORY OF SHORELINE RESPONSE MODELING AND GENESIS

96. In this chapter the theory of shoreline response modeling and its mathematical representation in GENESIS are described, including the numerical implementation of major calculation procedures. The physical and mathematical foundation of GENESIS and its internal structure are, therefore, the main subjects. External structural elements for operating the modeling system, i.e., the user interface and input/output files, are described in Part VI.

97. The basic assumptions underlying shoreline response modeling are first presented, and the equations used in GENESIS to calculate the longshore sand transport rate and shoreline change are introduced. The chapter also gives an overview of the wave calculation model internal to GENESIS. Important constructs unique to GENESIS, notably the concepts of wave energy windows and transport domains, are discussed, as are boundary conditions and constraints on the transport rate and position of the shoreline.

Basic Assumptions of Shoreline Change Modeling

98. A common observation is that the beach profile maintains an average shape that is characteristic of the particular coast, apart from times of extreme change as produced by storms. For example, steep beaches remain steep and gently sloping beaches remain gentle in a comparative sense and in the long term. Although seasonal changes in wave climate cause the position of the shoreline to move shoreward and seaward in a cyclical manner, with corresponding change in shape and average slope of the profile, the deviation from an average beach slope over the total active profile is relatively small. Pelnard-Considere (1956) originated a mathematical theory of shoreline response to wave action under the assumption that the beach profile moves parallel to itself, i.e., that it translates shoreward and seaward without changing shape in the course of eroding and accreting. He also verified his mathematical model by comparison to beach change produced by waves obliquely incident to a beach with a groin installed in a movable-bed physical model.

99. If the profile shape does not change, any point on it is sufficient to specify the location of the entire profile with respect to a baseline.

Thus, one contour line can be used to describe change in the beach plan shape and volume as the beach erodes and accretes. This contour line is conveniently taken as the readily observed shoreline, and the model is therefore called the "shoreline change" or "shoreline response" model. Sometimes the terminology "one-line" model, a shortening of the phrase "one-contour line" model, is used with reference to the single contour line.

100. A second geometrical-type assumption is that sand is transported alongshore between two well-defined limiting elevations on the profile. The shoreward limit is located at the top of the active berm, and the seaward limit is located where no significant depth changes occur, the so-called depth of profile closure. Restriction of profile movement between these two limits provides the simplest way to specify the perimeter of a beach cross-sectional area by which changes in volume, leading to shoreline change, can be computed.

101. The model also requires predictive expressions for the total longshore sand transport rate. For open-coast beaches, the transport rate is a function of the breaking wave height and direction alongshore. Since the transport rate is parameterized in terms of breaking wave quantities, the detailed structure of the nearshore current pattern does not directly enter.

102. Finally, it is assumed that there is a clear long-term trend in shoreline behavior. This must be the case in order to predict a steady signal of shoreline change from among the "noise" in the beach system produced by storms, seasonal changes in waves, tidal fluctuations, and other cyclical and random events. In essence, the assumption of a clear trend implies that the wave action producing longshore sand transport and boundary conditions are the major factors controlling long-term beach change. This assumption is usually well satisfied at engineering projects involving groins, jetties, and detached breakwaters, which introduce biases in the transport rate.

103. In summary, standard assumptions of shoreline change modeling are:

- a. The beach profile shape is constant.
- b. The shoreward and seaward limits of the profile are constant.
- c. Sand is transported alongshore by the action of breaking waves.
- d. The detailed structure of the nearshore circulation is ignored.
- e. There is a long-term trend in shoreline evolution.

104. The basic assumptions define a flexible and economical shoreline change simulation model that has been found applicable to a wide range of coastal engineering situations. However, it should be kept in mind that the assumptions are idealizations of complex processes and, therefore, have limitations. In a strict sense, the assumption that the beach profile moves parallel to itself along the entire modeled reach is violated in the vicinity of structures. For example, the slope of the profile on the updrift or accreting side of a jetty or long groin is usually more gentle than the slope of the beach distant from the structure. GENESIS will show shoreline advance in such a case, and a calibrated model may provide agreement with measured shoreline change, but the change in beach slope and sand volume contained in that change will not be reproduced. As a result, simulations in situations where the beach slope is expected to change significantly should be interpreted carefully.

105. Similarly, the depth of closure and the berm height along the modeled stretch of beach may vary alongshore, whereas these quantities are constant in the model. Values for berm elevation and depth of profile closure representative of the entire beach must be carefully determined. The transport rate formula contained in Version 2 of GENESIS describes longshore sand transport produced solely by incident waves. It does not describe transport produced by tidal currents, wind, or other forcing agents, indicating that the model should not be used if breaking waves are not the dominant mechanism for transport sand alongshore. As described below, GENESIS can account for the vertical and cross-shore distributions of longshore sand transport at groins and jetties in an empirical fashion. It does not account for the full vertical and horizontal water and sand circulation, making it incapable, for example, of describing transport by rip currents, undertow or return flow, or other 3-D fluid and transport processes.

106. The assumption that there must be a long-term trend in shoreline evolution means that a boundary condition or some other systematic process, for example, a river discharge, or a regular change in the wave pattern such as produced by a detached breakwater, dominates the beach change. This will normally be the case at engineering projects.

Governing Equation for Shoreline Change

107. The equation governing shoreline change is formulated by conservation of sand volume. Consider a right-handed Cartesian coordinate system in which the y-axis points offshore and the x-axis is oriented parallel to the trend of the coast (Figure 6). The quantity y^* thus denotes shoreline position, and x denotes distance alongshore. It is assumed that the beach profile translates seaward or shoreward along a section of coast without changing shape when a net amount of sand enters or leaves the section during a time interval Δt . The change in shoreline position is Δy , the length of the shoreline segment is Δx , and the profile moves within a vertical extent defined by the berm elevation D_B and the closure depth D_C , both measured from the vertical datum (for example, MSL or MLLW).

108. The change in volume of the section is $\Delta V = \Delta x \Delta y (D_B + D_C)$ and is determined by the net amount of sand that entered or exited the section from its four sides. One contribution to the volume change results if there is a difference ΔQ in the longshore sand transport rate Q at the lateral sides of the cells. This net volume change is $\Delta Q \Delta t = (\partial Q / \partial x) \Delta x \Delta t$. Another contribution can arise from a line source or sink of sand $q = q_s + q_o$, which adds or removes a volume of sand per unit width of beach from either the shoreward side at the rate of q_s or the offshore side at the rate of q_o . These produce a volume change of $q \Delta x \Delta t$. Addition of the contributions and equating them to the volume change gives $\Delta V = \Delta x \Delta y (D_B + D_C) = (\partial Q / \partial x) \Delta x \Delta t + q \Delta x \Delta t$. Rearrangement of terms and taking the limit as $\Delta t \rightarrow 0$ yields the governing equation for the rate of change of shoreline position:

$$\frac{\partial y}{\partial t} + \frac{1}{(D_B + D_C)} \left[\frac{\partial Q}{\partial x} - q \right] = 0 \quad (1)$$

109. In order to solve Equation 1, the initial shoreline position over the full reach to be modeled, boundary conditions on each end of the beach, and values for Q , q , D_B , and D_C must be given.

* For convenience, symbols and abbreviation are listed in the Notation (Appendix E).

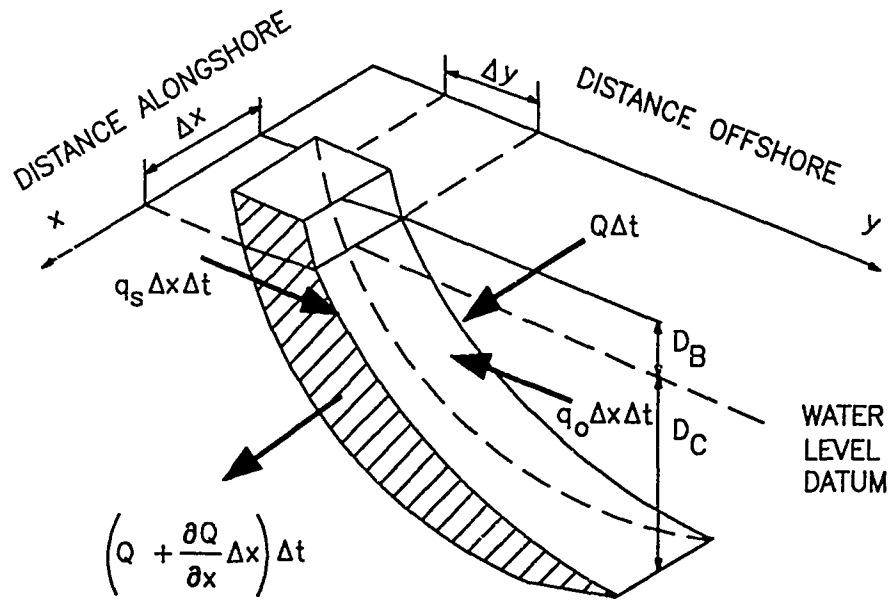

a. Cross-section view

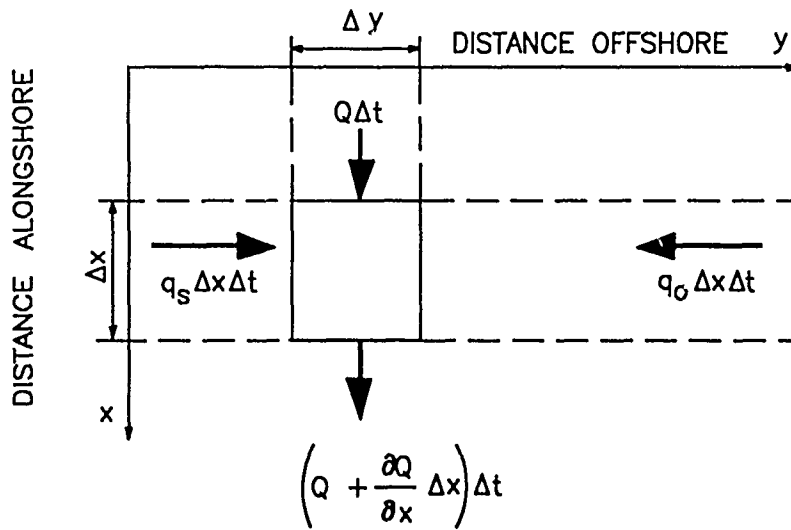

b. Plan view

Figure 6. Definition sketch for shoreline change calculation

Sand Transport Rates

Longshore sand transport

110. The empirical predictive formula for the longshore sand transport rate used in GENESIS is

$$Q = (H^2 C_g)_b \left[a_1 \sin 2\theta_{bs} - a_2 \cos \theta_{bs} \frac{\partial H}{\partial x} \right]_b \quad (2)$$

where

H = wave height

C_g = wave group speed given by linear wave theory

b = subscript denoting wave breaking condition

θ_{bs} = angle of breaking waves to the local shoreline

The nondimensional parameters a_1 and a_2 are given by

$$a_1 = \frac{K_1}{16(\rho_s/\rho - 1)(1 - p)(1.416)^{5/2}}$$

and

$$a_2 = \frac{K_2}{8(\rho_s/\rho - 1)(1 - p)\tan\beta(1.416)^{7/2}} \quad (3)$$

where

K_1, K_2 = empirical coefficient, treated as a calibration parameter

ρ_s = density of sand (taken to be $2.65 \cdot 10^3$ kg/m³ for quartz sand)

ρ = density of water ($1.03 \cdot 10^3$ kg/m³ for seawater)

p = porosity of sand on the bed (taken to be 0.4)

$\tan\beta$ = average bottom slope from the shoreline to the depth of active longshore sand transport

The factors involving 1.416 are used to convert from significant wave height, the statistical wave height required by GENESIS, to root-mean-square (rms) wave height.

111. The first term in Equation 2 corresponds to the "CERC formula" described in the SPM (1984) and accounts for longshore sand transport produced by obliquely incident breaking waves. A value of $K_1 = 0.77$ was originally determined by Komar and Inman (1970) from their sand tracer experiments, using rms wave height in the calculations. Kraus et al. (1982) recommended a decrease from 0.77 to 0.58 on the basis of their tracer experiments. As this order of magnitude for K_1 is well known in the literature, the standard engineering quantity of significant wave height is converted to an rms value by the factor 1.416 to compare values of K_1 determined by calibration of the model. The design value of K typically lies within the range of 0.58 to 0.77.

112. The second term in Equation 2 is not part of the CERC formula and is used to describe the effect of another generating mechanism for longshore sand transport, the longshore gradient in breaking wave height $\partial H_b / \partial x$. This contribution to the longshore transport rate was introduced into shoreline change modeling by Ozasa and Brampton (1980). The contribution arising from the longshore gradient in wave height is usually much smaller than that from oblique wave incidence in an open-coast situation. However, in the vicinity of structures, where diffraction produces a substantial change in breaking wave height over a considerable length of beach, inclusion of the second term provides an improved modeling result (Kraus 1983; Kraus and Harikai 1983; Mimura, Shimizu, and Horikawa 1983), accounting for the diffraction current.

113. Although the values of K_1 and K_2 have been empirically estimated, these coefficients are treated as parameters in calibration of the model and will be called "transport parameters" hereafter. The transport parameter K_1 controls the time scale of the simulated shoreline change, as well as the magnitude of the longshore sand transport rate. This control of the time scale and magnitude of the longshore sand transport rate is performed in concert with the factor $1/(D_B + D_C)$ appearing in Equation 1, as discussed in a later section. The value of K_2 is typically 0.5 to 1.0 times that of K_1 . It is not recommended to vary K_2 much beyond $1.0K_1$, as exaggerated shoreline change may be calculated in the vicinity of structures and numerical instability may occur.

114. In summary, because of the many assumptions and approximations that have gone into formulation of the shoreline response model, and to account for the actual sand transport along a given coast, the coefficients K_1 and K_2 are treated as calibration parameters in the model. Their values are determined by reproducing measured shoreline change and order of magnitude and direction of the longshore sand transport rate.

Sources and sinks

115. The quantity q in Equation 1 represents a line source or sink of sand in the system. Typical sources are rivers and cliffs, whereas typical sinks are inlets and entrance channels. Wind-blown sand at the shore can act as either a source or sink on the landward boundary, depending on wind direction. General predictive formulas cannot be given for the shoreward and seaward rates q_s and q_o , whose values depend on the particular situation. These quantities typically vary with time and are a function of distance alongshore. Kraus and Harikai (1983) modeled the effects of river discharge and subsequent sand shoaling on the beach by means of a source term. The capability to represent sources and sinks is not included in Version 2 of GENESIS. As an alternative, a beach-fill volume (shoreline advance or retreat) providing the same rate as a source or sink can be implemented.

Direct change in shoreline position

116. The position of the shoreline can also change directly, for example, as a result of beach fill or dredging. In this case, the profile is translated shoreward or seaward, as required, by a specified amount that can be a function of time and distance alongshore. GENESIS allows specification of a direct change in shoreline position, which may be positive (seaward), as caused by beach fill; or negative (landward), as by sand mining.

Empirical Parameters

Depth of longshore transport

117. The width of the profile over which longshore transport takes place under a given set of wave conditions is needed to estimate the amount of sand (percentage of total) bypassing occurring at groins and jetties. Since the major portion of alongshore sand movement takes place in the surf zone,

this distance is approximately equal to the width of the surf zone, which depends on the incident waves, principally the breaking wave height.

118. In GENESIS, the sand bypassing algorithm requires a depth of active longshore transport, which is directly related to the width of the surf under the assumption that the profile is a monotonically increasing function of distance offshore, as discussed in the next section. In Version 2 of GENESIS, a quantity called "the depth of active longshore transport," D_{LT} is defined and set equal to the depth of breaking of the highest one-tenth waves at the updrift side of the structure. Under standard assumptions, this depth is related to the significant wave height $H_{1/3}$ used throughout GENESIS, by

$$D_{LT} = \frac{1.27}{\gamma} (H_{1/3})_b \quad (4)$$

where

1.27 = conversion factor between one-tenth highest wave height and significant wave height

γ = breaker index, ratio of wave height to water depth at breaking

$(H_{1/3})_b$ = significant wave height at breaking

If $\gamma = 0.78$ is used in Equation 4, then $D_{LT} \approx 1.6(H_{1/3})_b$. The depth defining the seaward extent of the zone of active longshore transport D_{LT} is much less than the depth of closure D_C , except under extremely high waves.

119. GENESIS uses another characteristic depth, termed the "maximum depth of longshore transport" D_{LT0} to calculate the average beach slope $\tan\beta$ appearing in Equation 2. The quantity D_{LT0} is calculated as

$$D_{LT0} = (2.3 - 10.9H_0/L_0) \frac{H_0}{L_0} \quad (5)$$

where

H_0/L_0 = wave steepness in deep water

H_0 = significant wave height in deep water

L_0 = wavelength in deep water

The deepwater wavelength is calculated from linear wave theory as

$L_0 = gT^2/2\pi$, in which g is the acceleration due to gravity, and T is the

wave period. If spectral wave information is given, T is taken as the peak spectral wave period; otherwise, it is the period associated with the significant waves. Equation 5 was introduced by Hallermeier (1983) to estimate an approximate annual limit depth of the littoral zone under extreme waves. In the framework of GENESIS, D_{LT0} is calculated at each time step from the deepwater wave data and is assumed to be valid over the entire longshore extent of the modeled reach. Since wave characteristics vary seasonally, this definition of the maximum depth of longshore transport will reflect changes in average profile shape and beach slope, as described next.

Average profile shape and slope

120. The shoreline change equation does not require specification of the bottom profile shape since it is assumed that the profile moves parallel to itself. However, to determine the location of breaking waves alongshore and to calculate the average nearshore bottom slope used in the longshore transport equation, a profile shape must be specified. For this purpose, the equilibrium profile shape deduced by Bruun (1954) and Dean (1977) is used. They demonstrated that the average profile shape for a wide variety of beaches can in general be represented by the simple mathematical function

$$D = Ay^{2/3} \quad (6)$$

in which D is the water depth, and A is an empirical scale parameter. The scale parameter A has been shown by Moore (1982) to depend on the beach grain size. For use in GENESIS, the design curve for A given by Moore was approximated by a series of lines given as a function of the median nearshore beach grain size d_{50} (d_{50} expressed in mm and units of A of $m^{1/3}$):

$$\begin{aligned} A &= 0.41 (d_{50})^{0.94} & , & \quad d_{50} < 0.4 \\ A &= 0.23 (d_{50})^{0.32} & , & \quad 0.4 \leq d_{50} < 10.0 \\ A &= 0.23 (d_{50})^{0.28} & , & \quad 10.0 \leq d_{50} < 40.0 \\ A &= 0.46 (d_{50})^{0.11} & , & \quad 40.0 \leq d_{50} \end{aligned} \quad (7)$$

If beach survey profiles for the target beach are available, it is recommended that the modeler use the curves in Figure 7 as templates to determine an effective median grain size. The effective grain size, if supplied to GENESIS, will produce an A-value that will give the most representative profile shape. If profile survey data are lacking, the median grain size of the surf zone sand should be used.

121. The average nearshore slope $\tan\beta$ for the equilibrium profile defined by Equation 6 is calculated as the average value of the integral of the slope $\partial D/\partial y$ from 0 to y_{LT} , resulting in $\tan\beta = A(y_{LT})^{-1/3}$, in which y_{LT} is the width of the littoral zone, extending seaward to the depth D_{LT0} . Since by definition, $y_{LT} = (D_{LT0}/A)^{3/2}$, the average slope is calculated to be

$$\tan\beta = \left[\frac{A^3}{D_{LT0}} \right]^{1/2} \quad (8)$$

Depth of closure

122. The depth of closure, the seaward limit beyond which the profile does not exhibit significant change in depth, is a difficult parameter to quantify. Empirically, the location of profile closure D_c cannot be identified with confidence, as small bathymetric change in deeper water is extremely difficult to measure. This situation usually results in a depth of closure located within a wide range of values, requiring judgment to be exercised to specify a single value. Often profile surveys are not available to a sufficient depth and with sufficient vertical and horizontal control to allow comparisons of profiles to be made. Figure 8a shows the standard deviation of depth values from five wide-scale bathymetric surveys plotted as a function of mean depth for Oarai, a Pacific Ocean beach in Japan (Kraus and Harikai 1983). Figure 8b shows a similar plot composed of data from multiple profile surveys made over a 4-year period along nine transects at Oceanside, California. Changes in the profile fall off at a depth of about 6 m for the case of Oarai and at about 30 ft National Geodetic Vertical Datum (NGVD) for the case of Oceanside. These values were used as the depths of closure in the respective shoreline response models.

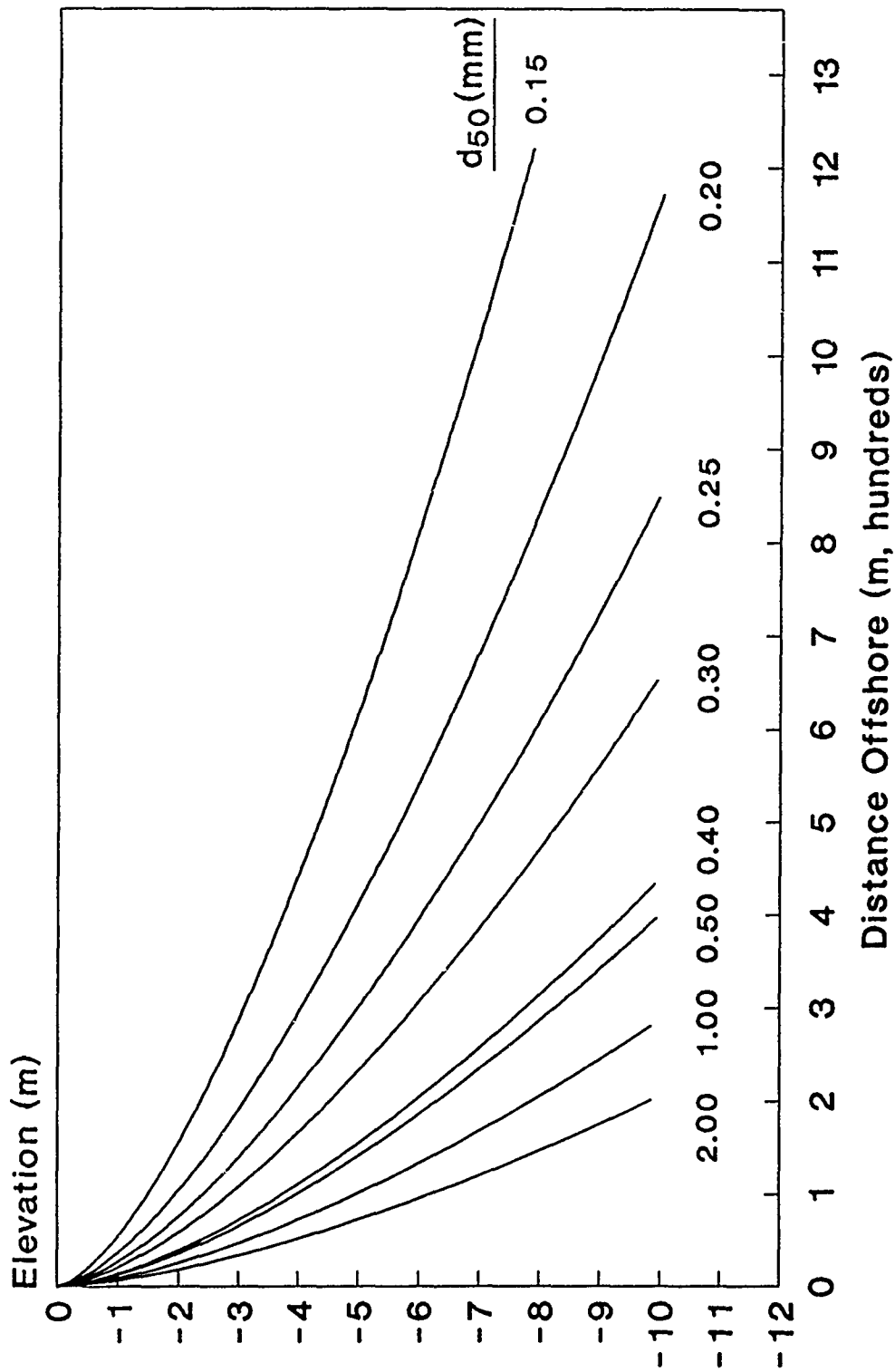

a. Metric units

Figure 7. Template to determine the effective sand grain size (Continued)

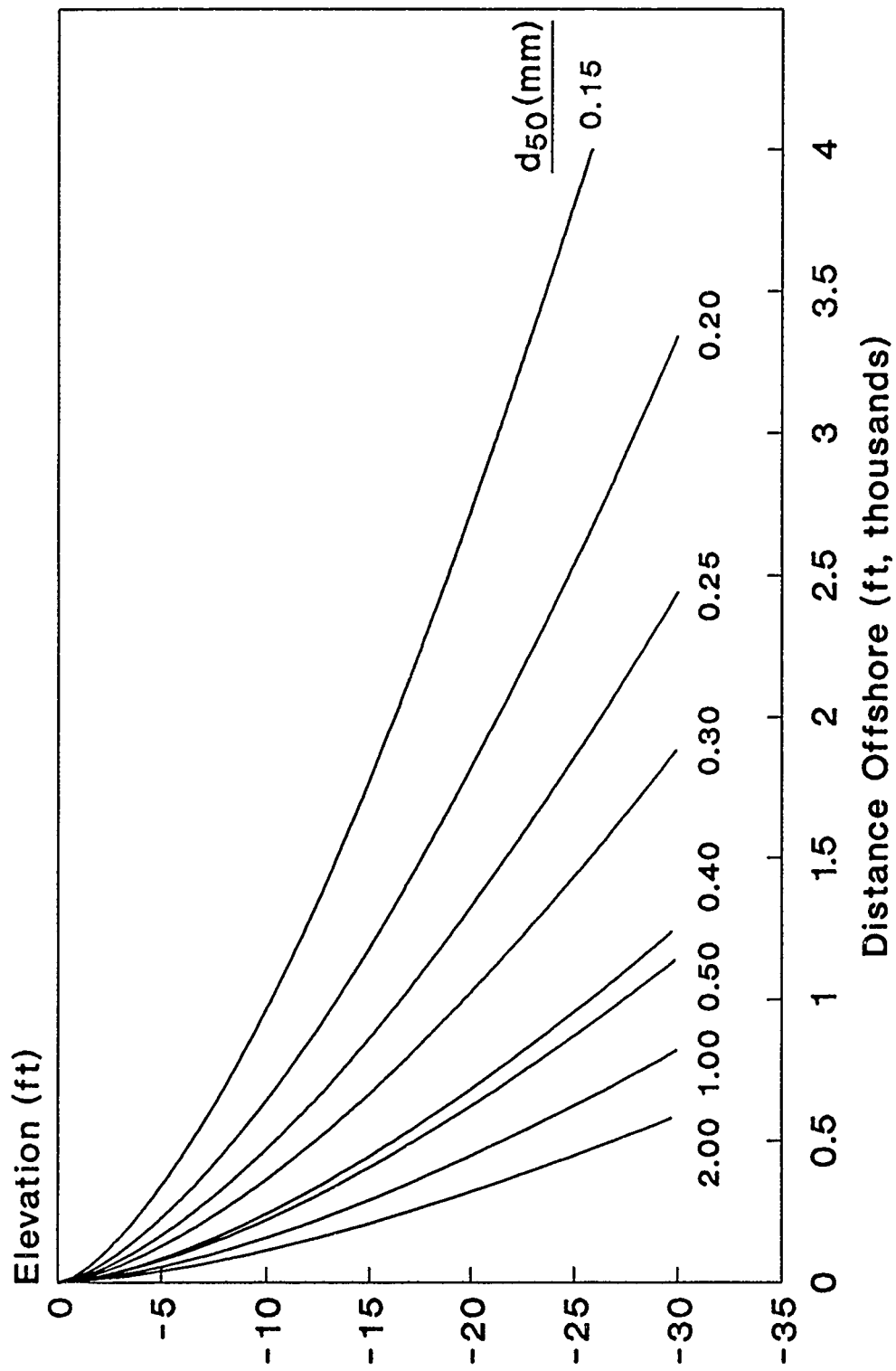

b. American customary units

Figure 7. (Concluded)

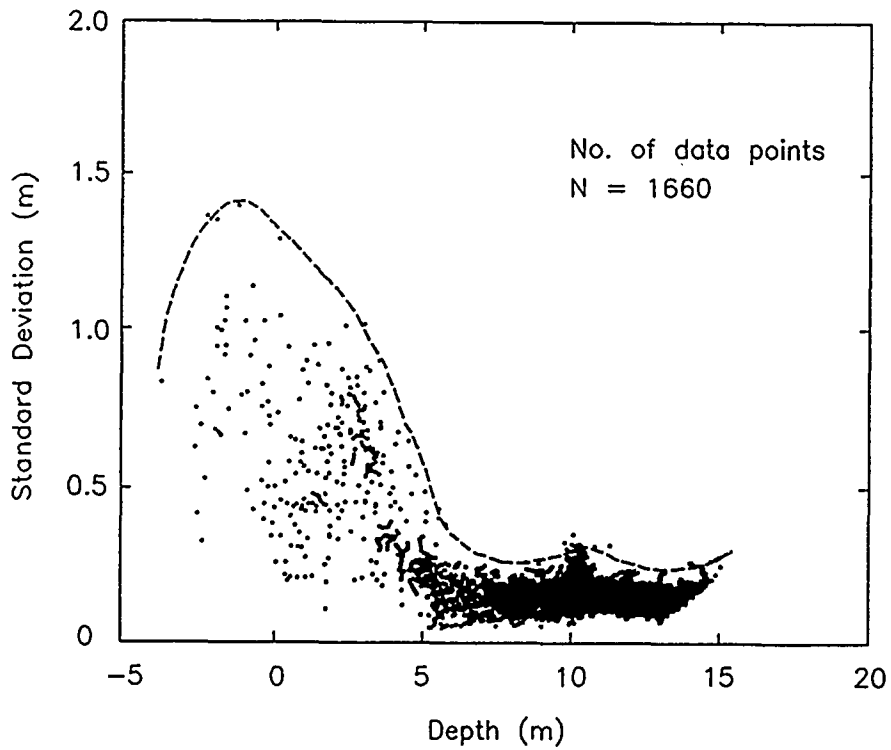

a. Depth changes at Oarai Beach, Japan

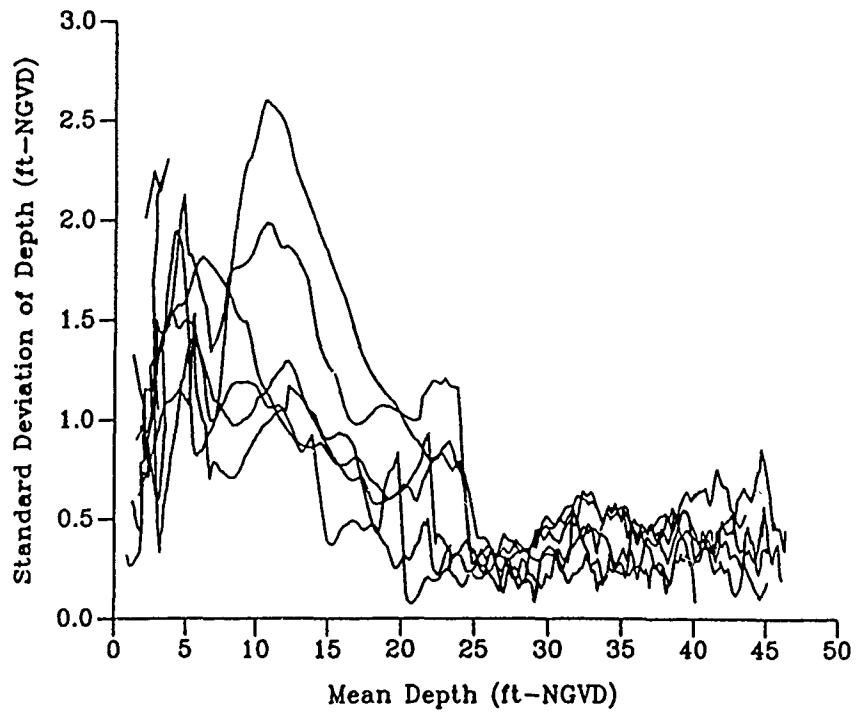

b. Depth Changes at Oceanside, California

Figure 8. Empirical determination of the depth of closure

123. Alternatively, the depth of closure may be estimated by reference to a maximum seasonal or annual wave height. Hallermeier (1983) found that the maximum seaward limit of the littoral zone could be expressed by Equation 5 if the wave height and period are given by the averages of the highest significant waves occurring for 12 hr during the year.

124. Since the depth of closure is difficult to estimate at most sites, the modeler must use some external means to determine a value for the particular project. It is recommended that both bathymetry (profile) surveys and Equation 5 be used as a check of the consistency of values obtained. On an open-ocean coast, the depth of closure is not expected to show significant longshore variation, since the wave climate and sand characteristics would be similar. However, in the lee of large structures such as long harbor jetties and breakwaters, the wave climate is milder due to sheltering, and the depth of closure should be smaller. This effect is not accounted for in GENESIS, which uses an average closure depth for the entire modeled reach.

Wave Calculation

125. Offshore wave information can be obtained from either a "numerical" gage, i.e., a hindcast calculation, or from an actual wave gage. Wave data are input to the model at a fixed time interval, typically in the range of 6 to 24 hr. The wave height and direction at the gage must be transformed to breaking at intervals alongshore for input to GENESIS. Monochromatic wave models hold the wave period constant in this process.

126. The modeling system GENESIS is composed of two major submodels. One submodel calculates the longshore sand transport rate and shoreline change. The other submodel is a wave model that calculates, under simplified conditions, breaking wave height and angle alongshore as determined from wave information given at a reference depth offshore. This submodel is called the internal wave transformation model, as opposed to another, completely independent, external wave transformation model which can be optionally used to supply nearshore wave information to GENESIS. The availability and reliability of wave data as well as the complexity of the nearshore bathymetry should be used to evaluate which wave model to apply.

127. Use of the internal and external wave transformation models is depicted in Figure 9. The internal model is applicable to a sea bottom with approximately straight and parallel contours, and breaker height and angle are calculated at grid points alongshore starting from the reference depth of the offshore wave input (Figure 9a). If an external wave model is used (Figure 9b), it calculates wave transformation over the actual (irregular) bathymetry starting at the offshore reference depth. Resultant values of wave height and direction at depths alongshore for which wave breaking has not yet occurred are placed in a file (by the modeler) for input to the internal wave model. These depths, taken, for example, as the depths in each wave calculation cell immediately outside the 6-m contour, define a "nearshore reference line," from which the internal wave model in GENESIS takes over grid cell by grid cell to bring the waves to the breaking point. If structures that produce diffraction are located in the modeling reach, the internal model will automatically include the effect of diffraction in the process of determining breaking wave characteristics.

Internal Wave Transformation Model

Breaking waves

128. Wave transformation from the deepwater reference depth or the nearshore reference line (depending on whether or not the external wave model is used) is initially done without accounting for diffraction from structures or landmasses located in the model reach. The solution strategy is to obtain a first approximation without including diffraction and then modify the result by accounting for changes to the wave field by each diffraction source.

129. Omitting diffraction, there are three unknowns in the breaking wave calculation: the wave height, wave angle, and depth at breaking. Three equations are needed to obtain these quantities. These are the equation for the breaking wave height based on reference wave data (Equation 9), a depth-limited breaking criterion (Equation 14), and a wave refraction equation (Equation 16).

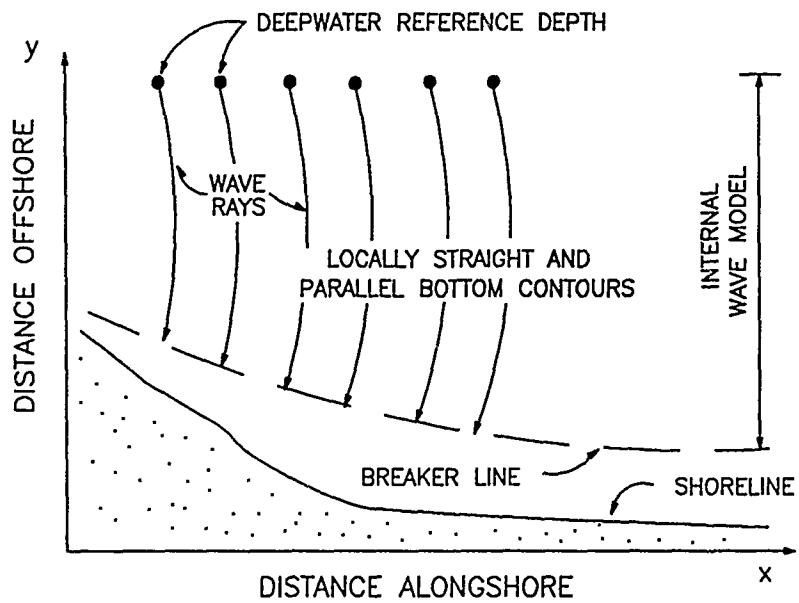

a. Transformation by internal wave model only

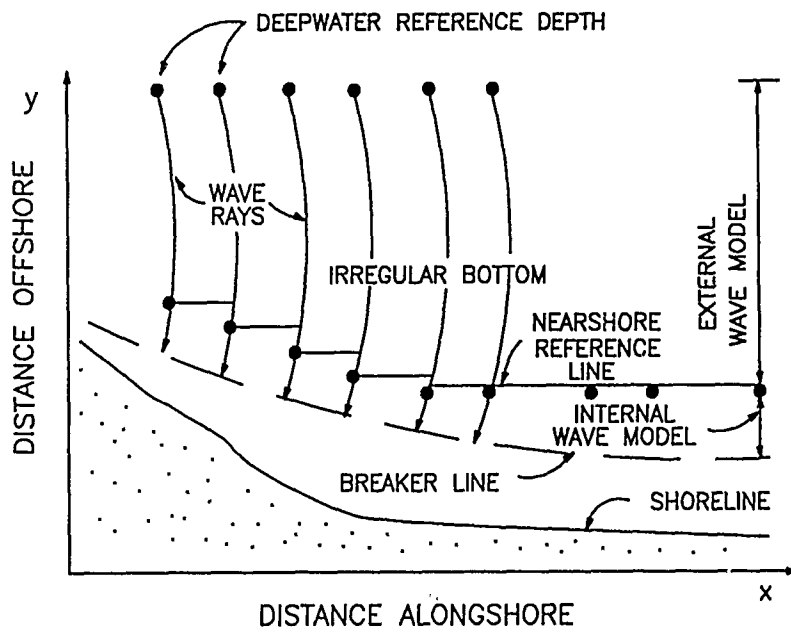

b. Transformation by external and internal wave models

Figure 9. Operation of wave transformation models

130. Equation 9 is used to calculate the height of breaking waves that have been transformed by refraction and shoaling (Figure 10):

$$H_2 = K_R K_S H_{ref} \quad (9)$$

where

H_2 = breaking wave height at an arbitrary point alongshore

K_R = refraction coefficient

K_S = shoaling coefficient

H_{ref} = wave height at the offshore reference depth or the nearshore reference line depending on which wave model is used

131. The refraction coefficient K_R is a function of the starting angle of the ray and the angle of arrival at P_2 , the location of which is determined by the breaking depth. K_R is given by

$$K_R = \left[\frac{\cos \theta_1}{\cos \theta_2} \right]^{1/2} \quad (10)$$

in which θ_2 is the angle of the breaking wave at P_2 .

132. The shoaling coefficient K_S is a function of the wave period, the depth at P_1 , and the breaker depth and is given by:

$$K_S = \left[\frac{C_{g1}}{C_{g2}} \right]^{1/2} \quad (11)$$

in which C_{g1} and C_{g2} are the wave group speeds at P_1 and the initial break point, respectively. The group speed is defined as

$$C_g = Cn \quad (12)$$

where

C = wave phase speed = L/T

L = wavelength at the depth D

$n = 0.5[1 + (2\pi D/L)/\sinh(2\pi D/L)]$

133. The wavelength is calculated from the dispersion relation,

$$L = L_o \tanh\left[\frac{2\pi D}{L}\right] \quad (13)$$

To minimize computer execution time, a rational approximation (Hunt 1979) with an accuracy of 0.1 percent is used to solve the transcendental Equation 13.

134. The equation for depth-limited wave breaking is given by

$$H_b = \gamma D_b \quad (14)$$

in which D_b is the depth at breaking and the breaker index γ is a function of the deepwater wave steepness and the average beach slope (Smith and Kraus, in preparation):

$$\gamma = b - a \frac{H_o}{L_o} \quad (15)$$

in which $a = 5.00 [1 - \exp(-43 \tan\beta)]$ and $b = 1.12/[1 + \exp(-60 \tan\beta)]$.

135. The wave angle at breaking is calculated by means of Snell's law,

$$\frac{\sin\theta_b}{L_b} = \frac{\sin\theta_1}{L_1} \quad (16)$$

in which θ_b and L_b are the angle and wavelength at the break point, and θ_1 and L_1 are the corresponding quantities at an offshore point.

136. The three unknowns, H_b , D_b , and θ_b , are obtained at intervals alongshore by iterative solution of Equations 9, 14, and 16 as a function of the wave height and angle at the reference depth and the wave period.

137. Wave refraction models provide the undiffracted breaking wave angle θ_b in the fixed coordinate system. With reference to Figure 10, the breaking wave angle to the shoreline required to calculate the longshore sand transport rate, Equation 2, is obtained as

$$\theta_{bs} = \theta_b - \theta_s \quad (17)$$

in which $\theta_s = \tan^{-1}(\partial y/\partial x)$ is the angle of the shoreline with respect to the x-axis. In GENESIS, an angle of 0 deg signifies shore-normal wave incidence. The angle θ_b drawn in Figure 10 is positive.

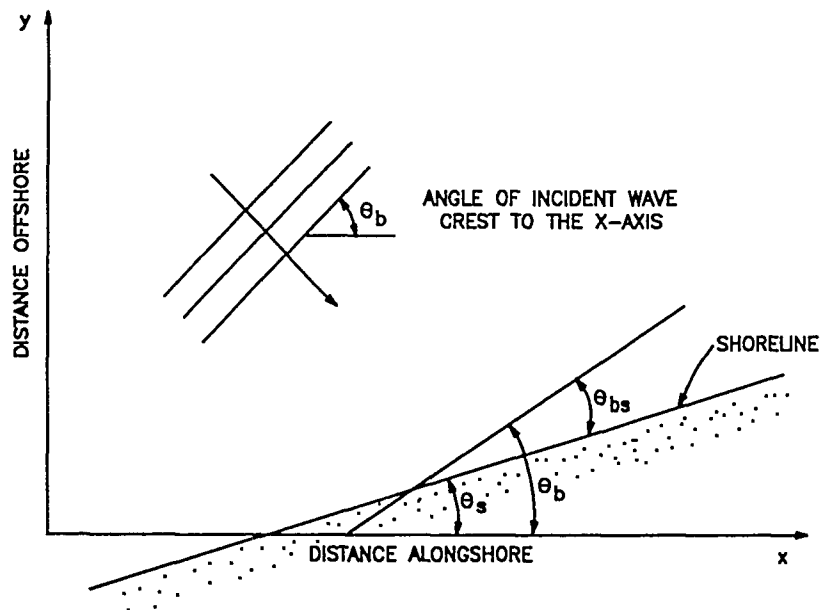

Figure 10. Definition of breaking wave angles

138. If there are no structures to produce diffraction, the undiffracted wave characteristics are used as input to the sediment transport relation (Equation 2). If such obstacles are present, breaking wave heights and directions are recalculated, as described next.

Breaking waves affected by structures

139. Structures such as detached breakwaters, jetties, and groins that extend well seaward of the surf zone intercept the incident waves prior to breaking. Headlands and islands may also intercept waves. In the following discussion, all such objects are referred to as structures. Each tip of a structure will produce a near-circular wave pattern, and this distortion of the wave field is a significant factor controlling the response of the shoreline in the lee of the structure. Sand typically accumulates in the diffraction shadow of a structure, being transported from one or both sides by the oblique wave angles in the circular wave pattern and the decrease in wave height alongshore with penetration into the shadow region. Accurate and

efficient calculation of waves transforming under combined diffraction, refraction, and shoaling to break is required to obtain realistic predictions of shoreline change in such situations.

140. Figure 11 is a definition sketch of the calculation procedure for the breaking wave height and angle behind a structure (Kraus 1981, 1982, 1984). Conceptually, the area of interest is separated into a shadow region and an illuminated region by a wave ray directed toward the beach from the tip of the structure at the same angle as the incident waves arriving at the tip. To determine the breaking wave height, a diffraction coefficient must be calculated in both regions because the diffraction effect can extend far into the illuminated region. To determine the breaking wave angle, inside the shadow region, wave rays are assumed to proceed radially from the tip of the structure P_1 at an angle θ_1 to arrive at some point P_2 , where they break.

141. The angle θ_1 at which a wave ray must start to arrive at P_2 inside the shadow region is not known a priori since it is a function of the breaking criterion as well as the distance alongshore defining the location of grid cells in the numerical calculation. A ray shooting technique can be used to determine θ_1 (Kraus 1982, 1984), but this procedure is complex and requires considerable execution time. As an approximation, the geometric angle θ_g defined by the straight line between P_1 and P_2 is used.

142. In areas affected by diffraction, Equation 18 is used to calculate the height of breaking waves that have been transformed by diffraction, refraction, and shoaling

$$H_b = K_D(\theta_D, D_b)H'_b \quad (18)$$

where

K_D - diffraction coefficient

θ_D - angle between incident wave ray at P_1 and straight line between P_1 and P_2 , if P_2 is in the shadow region

H'_b - breaking wave height at the same cell without diffraction

The diffraction, refraction, shoaling coefficients are also functions of the depth at P_1 and the wave period, but these quantities are known and, therefore, not included in the function arguments in Equation 18.

143. The three unknowns, H_b , D_b , and θ_b , are obtained at intervals alongshore by iterative solution of Equation 18 together with Equations 14 and 16 as a function of wave height and angle at the breaking depth and period.

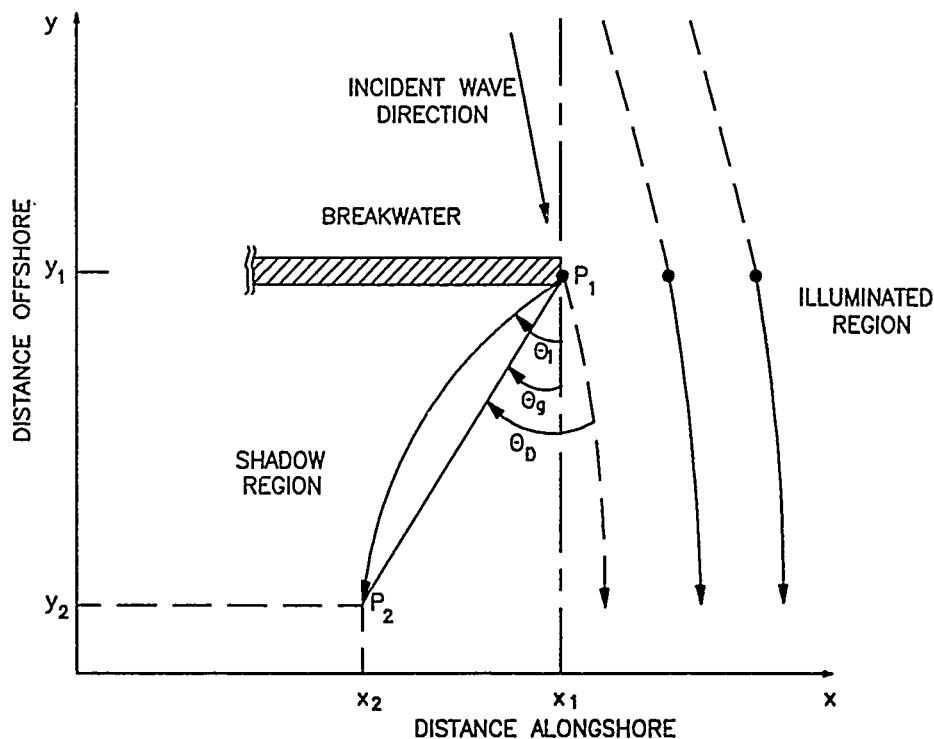

Figure 11. Definition sketch for wave calculation

144. Diagrams that give contours of the diffraction coefficient for monochromatic waves (in uniform water depth) can be found, for example, in Chapter 2 of the SPM (1984). In these diagrams, the value of the diffraction coefficient along the line of wave incidence defining the shadow and illuminated regions is about 0.5, indicating that the wave height is about 50 percent reduced along this line. However, for the field situation of sea waves having a spread about the principal direction of incidence, the reduction in wave height is not expected to be as great as for monochromatic waves. Goda, Takayama, and Suzuki (1978) developed methods for calculating diffraction of random waves as caused by large land masses based on the concept of

directional spreading of waves and penetration of energy to the lee of a land mass or long structure. Their results show that the value of the diffraction coefficient along the separation line is about 0.7.

145. Because GENESIS was developed to simulate waves and shoreline change in the field, the procedure of Goda, Takayama, and Suzuki (1978) (see also, Goda (1984)) was adapted. Details of application of the method to calculate wave breaking produced by combined diffraction, refraction, and shoaling as used in GENESIS are given by Kraus (1981, 1982, 1984, 1988a). In GENESIS it is assumed that the method is valid for relatively short structures such as detached breakwaters.

Contour modification

146. The beach plan shape changes as a result of spatial differences in longshore sand transport. The change in the beach shape, in turn, alters the refraction of the waves. Within the framework of the wave model internal to GENESIS, the interaction between the beach and waves is accounted for in two ways. First, with change in position of the shoreline, the distance to the source of refraction (P_1 in Figure 12) will change, and hence the ray starting angle θ_1 will also change. Second, the shape of the shoreline will distort in the vicinity of a structure, and the offshore contours will tend to align with this shape. This effect is accounted for by assuming that the orientation of the shoreline at a particular point extends to the depth where the diffraction source or reference depth is located. Thus, although plane and parallel contours are assumed, their orientation is allowed to change as a function of position alongshore to conform with the local beach plan shape.

147. Such a local coordinate system aligned with the local contours is defined by the (x', y') axes in Figure 12. This coordinate system is rotated by the angle of orientation of the local shoreline $\theta_s = \tan^{-1}(\partial y/\partial x)$ evaluated at point P_3 . In the rotated coordinate system, an angle θ' is related to the angle θ in the fixed (original) system by $\theta' = \theta + \theta_s$. Equation 16 can be used to calculate wave refraction in the primed coordinate system but with angles on both sides replaced by corresponding primed wave angles. Similarly, the refraction coefficient (Equation 10) can be calculated

using primed wave angles. After the wave angle and wave transformation are calculated in the rotated system, the breaking wave angle is converted back to the fixed coordinate system for use in the longshore sand transport rate equation (Equation 2). Thus, in the shadow region, the breaking wave height is calculated as

$$H_b = K_D(\theta_D, D_b) K'_R(\theta'_1, D_b) H'_b \quad (19)$$

in which K'_R = refraction coefficient in the primed (rotated) coordinate system. Use of this contour modification technique significantly improves the accuracy of the internal wave model by giving a more realistic value of the breaking wave angle (Kraus 1983, Kraus and Harikai 1983). The contour modification is calculated automatically by the internal wave model in GENESIS in taking waves from a reference depth to the point of breaking.

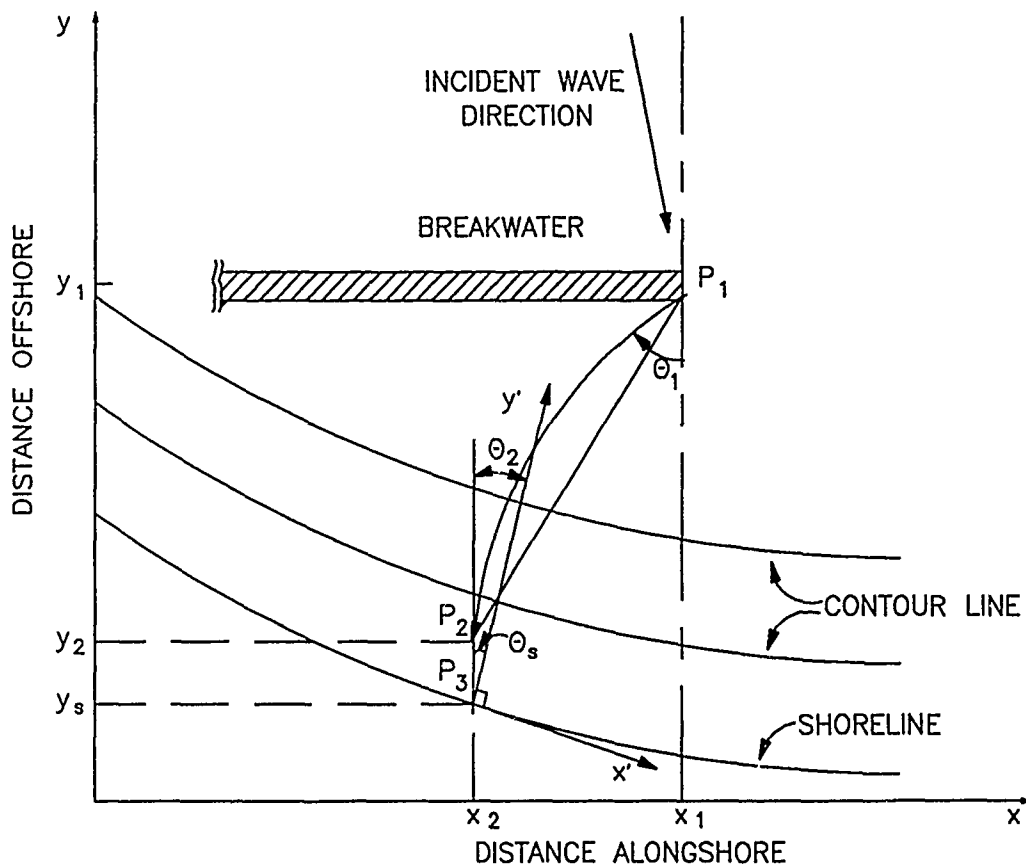

Figure 12. Wave angles in contour modification

Wave transmission at detached breakwaters

148. The design of detached breakwaters for shore protection requires consideration of many factors, including structure length, distance offshore, crest height, core composition, and gap between structures in the case of segmented breakwaters. Several studies (Perlin 1979; Kraus 1983; Kraus, Hanson, and Harikai 1984; Hanson 1989) have described numerical simulations of the influence of detached breakwaters on the shoreline. However, an important process absent in these works was wave transmission at the breakwaters. Wave transmission, referring to the movement of waves over and through a structure, is present in most practical applications, since it is economical and often advantageous from the perspective of beach change control to build low or porous structures to allow energy to penetrate behind them.

149. One of the principal upgrades of Version 2 of GENESIS over the previous version of the modeling system is the capability to simulate wave transmission at detached breakwaters and its impact on shoreline change. This capability was tested with excellent results for Holly Beach, Louisiana, a site containing six breakwaters of different construction and transmission characteristics (Hanson, Kraus, and Nakashima 1989).

150. In order to describe wave transmission in the modeling system, a value of a transmission coefficient K_T must be provided for each detached breakwater. The transmission coefficient, defined as the ratio of the height of the incident waves directly shoreward of the breakwater to the height directly seaward of the breakwater, has the range $0 \leq K_T \leq 1$, for which a value of 0 implies no transmission and 1 implies complete transmission.

151. The derivation of the phenomenological wave transmission algorithm in GENESIS was developed on the basis of three criteria:

- a. As K_T approaches zero, the calculated wave diffraction should equal that given by standard diffraction theory for an impermeable, infinitely high breakwater.
- b. If two adjacent energy windows have the same K_T , no diffraction should occur (wave height uniform at the boundary).
- c. On the boundary between energy windows with different K_T , wave energy should be conveyed from the window with higher waves into the window with smaller waves. The wave energy transferred should be proportional to the ratio between the two transmission coefficients.

152. The criteria lead to the following expression for the diffraction coefficient K_{DT} for transmissive breakwaters:

$$K_{DT} = \begin{cases} K_D + R_{KT}(1 - K_D) & \theta_D > 0 \\ K_D - R_{KT}(K_D - 0.5) & \theta_D = 0 \\ K_D(1 - R_{KT}) & \theta_D < 0 \end{cases} \quad (20)$$

in which R_{KT} is the ratio of the smaller valued transmission coefficient to the larger valued transmission coefficient for two adjacent breakwaters.

153. Figure 13 shows a hypothetical example of shoreline change behind a transmissive detached breakwater. The breakwater is 200 m long and located 250 m offshore. Incident waves with $T = 6$ sec and $H = 1.5$ m propagate with the wave crests parallel to the initially straight shoreline, and the simulation time is 180 hr. As expected, the seaward extent of the induced large cusp (salient) decreases as wave transmission increases. Also, the salient broadens slightly with increased transmission, and the eroded areas on either side of the salient fill in.

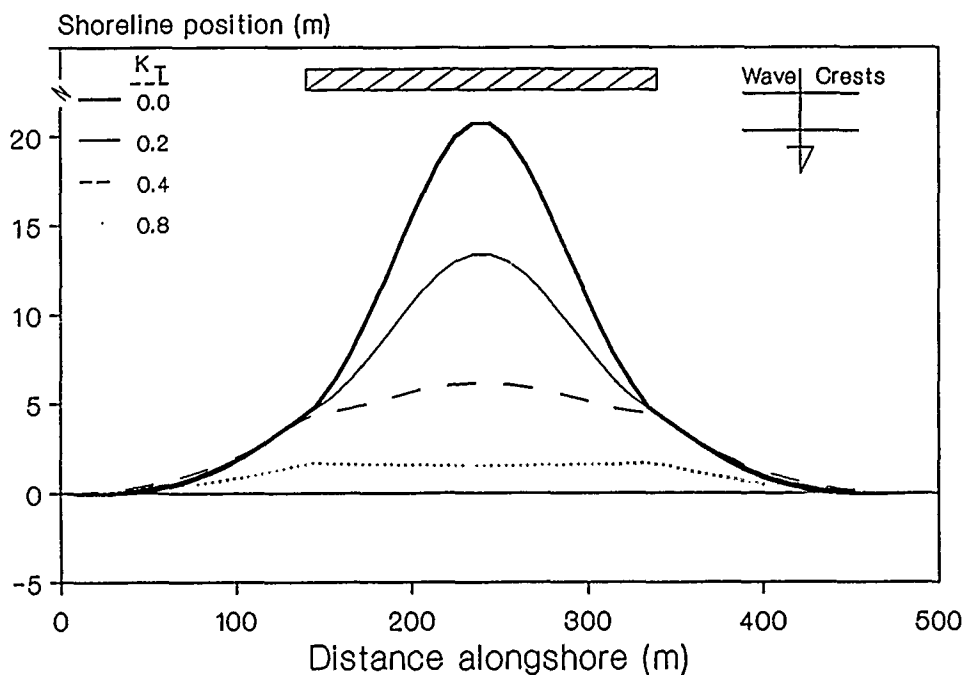

Figure 13. Shoreline change as a function of transmission

Representative offshore contour

154. A basic assumption in the formulation of the shoreline change model is that the profile moves parallel to itself. As a consequence, offshore contours move parallel to the shoreline. If this assumption is applied directly in the internal wave model, unrealistic wave transformation can result in regions where the shoreline position changes relatively abruptly, possibly leading to numerical instability. To overcome this limitation, GENESIS has the option of using a smoothed offshore contour in performing the internal wave calculation, as illustrated in Figure 14. In this figure, the shore-parallel contour shown changes radically at the groin. The smoothed contour is expected to better represent the offshore bathymetry. If the smoothed contour option is chosen, the contour is assumed to be representative for all contour lines between the input wave depth and the undiffracted wave breaking depth. The orientation of the representative offshore contour is recalculated on monthly intervals using the shoreline position at that time.

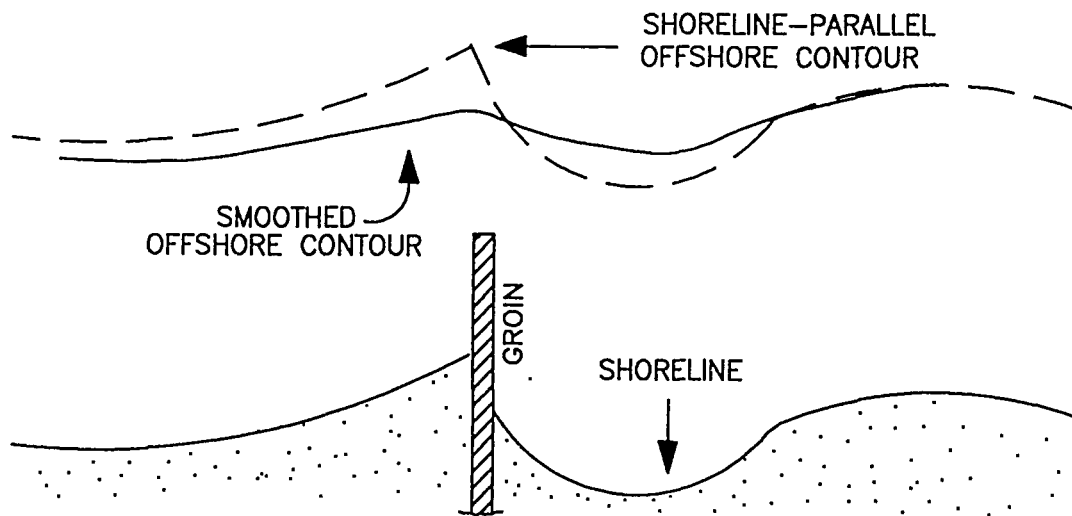

Figure 14. Example of representative contour

External Wave Transformation Model: RCPWAVE

155. In many applications offshore contours cannot be considered as plane and parallel. In these cases accurate modeling of shoreline change requires calculation of the nearshore waves using the actual bathymetry. For the open-coast situation, the linear wave transformation model RCPWAVE (Ebersole 1985; Ebersole, Cialone, and Prater 1985) has advantages for use with GENESIS:

- a. It solves for wave height and angle values directly on a grid.
- b. It is efficient, allowing wide-area coverage.
- c. It includes diffractive effects produced by an irregular bottom, thus reducing caustic generation as well as providing better accuracy than a pure refraction model.
- d. It has proven to be very stable.

156. RCPWAVE places values of wave height and direction at grid points on a nearshore reference line, shown schematically in Figure 9b. From this line the internal wave transformation model in GENESIS brings waves to breaking. Figure 15 shows GENESIS and RCPWAVE in the overall calculation flow.

157. Shoreline change simulation intervals are typically on the order of several years, and the extent of the modeled reach several kilometers, requiring hundreds of grid cells. Since the time step for the simulation is typically 6, 12, or 24 hr, thousands of wave calculations must be performed. It is impractical to run a wave transformation model such as RCPWAVE for each time step because of the enormous execution time involved. A general wave model runs on a two-dimensional grid, and its execution time is proportional to N^2 , where N is on the order of the number of grid cells in the x- and y-directions. In contrast, GENESIS is a one-dimensional model, and its execution time is proportional to N . Therefore, it is unbalanced in computational effort to perform a general wave calculation at every shoreline simulation time step. As a related physical consideration, time series of offshore waves are usually not available or, if available, contain uncertainties, implying that an expensive, accurate numerical wave transformation calculation would not be in balance with approximate input data.

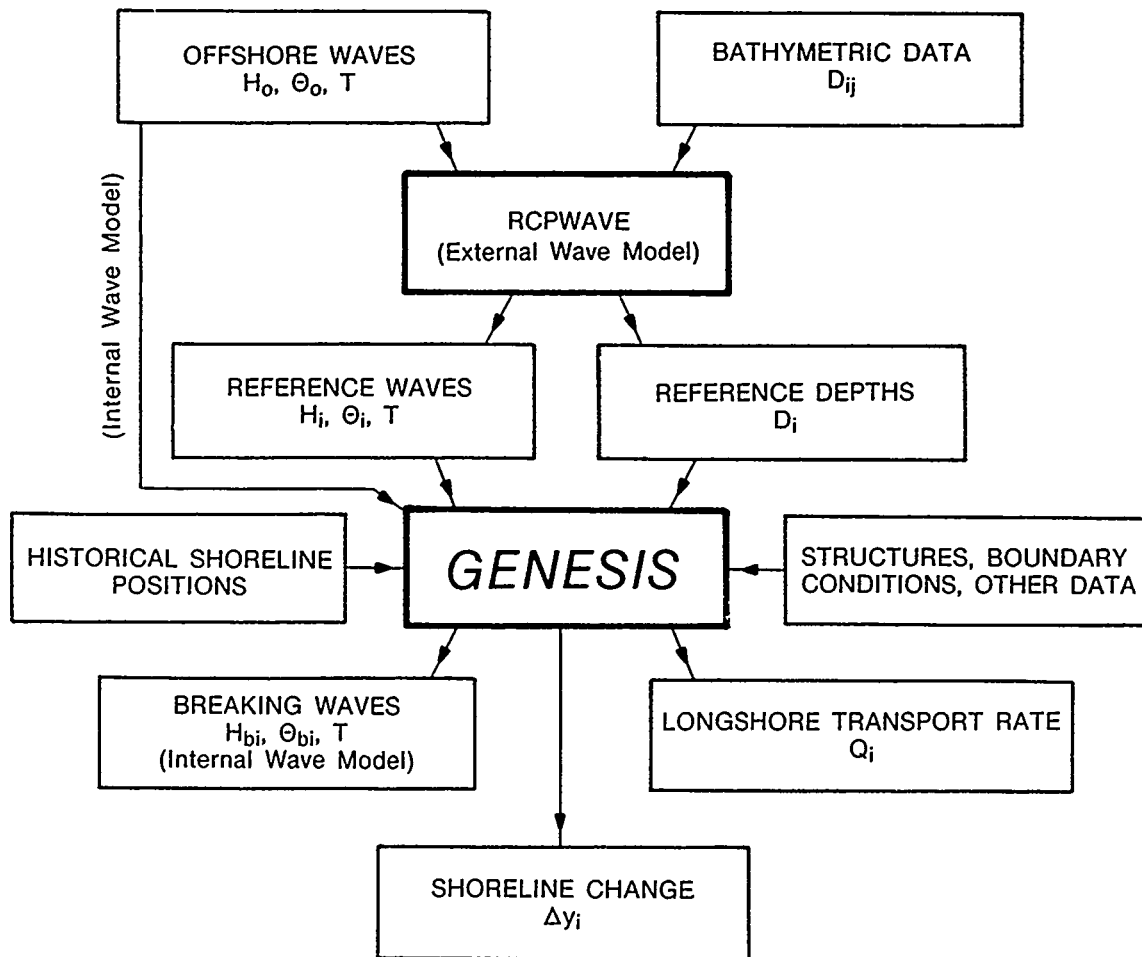

Figure 15. GENESIS, RCPWAVE, and the overall calculation flow

158. Rather than running the external wave model at every time step, a time savings technique is used in which the offshore wave conditions are divided into period and direction bands (Kraus et al. 1988). Typically, the range in period existing in the record is divided into 1-sec intervals, and the range in direction of incident waves is divided into 11.25- or 22.5-deg intervals. This procedure gives on the order of 50 to 100 period-direction bands, and refraction runs are made with the external wave model using unit wave height to provide what are termed "transformation coefficients" along the nearshore reference line. To key into these calculated refraction results,

the wave conditions in the offshore time series are grouped into the designated period-direction bands. The wave height on the nearshore reference line calculated with unit offshore wave height is then given as the product of the transformation coefficient alongshore and the input offshore wave height at the time step, which is permissible by linear wave theory. Thus, although the wave period and direction are constrained to lie in a finite number of bands, the actual offshore wave height is used. Since it is doubtful whether directional resolution greater than 11.25 or 22.5 deg can be achieved by either a deepwater wave gage or hindcast, the described procedure is an adequate representation of the data, yet it allows for efficient calculation. Smaller increments in wave angle could be implemented, if appropriate.

159. As an alternative to building a key for accessing the refraction results, nearshore wave conditions on the reference line thus calculated can be arranged in their order of occurrence in the offshore wave time series and a large data file of nearshore wave conditions generated and stored for input. In any case, manipulation of the wave data base requires substantial effort and is one of the necessary tasks that must be performed as part of the data preparation process if an external wave model is used. Practical details of the use of an external refraction model with GENESIS are given in the GENESIS Workbook.

Limiting Deepwater Wave Steepness

160. The input offshore wave data may be changed or manipulated for a number of reasons, for example, to examine model sensitivity, to look at extreme cases, and to run waves for storm (high-wave) conditions. In these investigations the wave height is usually increased. In the process, if care is not taken, it is possible to specify waves of unphysically large steepness. GENESIS performs a check that the offshore input wave steepness satisfies the Mitchell (1893) limiting wave steepness criterion:

$$\frac{H_o}{L_o} = 0.142 \quad (21)$$

If the calculated wave steepness exceeds the value of 0.142, the deepwater wave height is reduced to satisfy Equation 21, maintaining input wave period at the same value. A warning message is also issued.

Wave Energy Windows

161. The concept of wave energy windows is central to GENESIS and determines its algorithmic structure. Wave energy windows provide a powerful means of describing breaking wave conditions alongshore and the associated sand transport for a wide variety of configurations of coastal structures.

Energy windows

162. An energy window is an area open to incident waves as viewed from a particular stretch of beach. Operationally, an energy window is defined by two boundaries that are regarded as limiting the penetration of waves to the target beach. Windows are separated by diffracting jetties, diffracting groins, nontransmissive detached breakwaters, and the tips of transmissive detached breakwaters. (The term "transmission" refers to the transmission of waves through or over a detached breakwater.) Incident wave energy must enter through one of these windows to reach a location in the nearshore area. It is possible (and common) for a location to be open to waves from more than one window.

Sand transport calculation domains

163. At the present stage of model development, shore-connected structures (jetties, groins, and breakwaters) are assumed not to transmit wave energy, so that waves entering on one side of such a structure cannot propagate to the other side. Based on the concept of wave energy windows and non-wave transmissibility of shore-connected structures, the shoreline is divided into what are called "sand transport calculation domains." These domains consist of segments of the coast bounded on each side by either a diffracting shore-connected structure or a model boundar . GENESIS solves the shoreline change equation independently for each domain, except for conditions such as sand passing around or through groins, which allow exchange of sand across the boundaries of the calculation domains.

Examples

164. Examples of wave energy windows and transport calculation domains for a hypothetical modeling project are given in Figure 16. In this and similar figures, a diffracting tip of a structure is indicated by emanating circular wavelets; nondiffracting tips of structures have no wavelets. Structures allowing wave transmission are also indicated by emanating wavelets. The vertical scale on this figure is greatly exaggerated. The energy windows are labeled by E1-E5 and the structures by S1-S6.

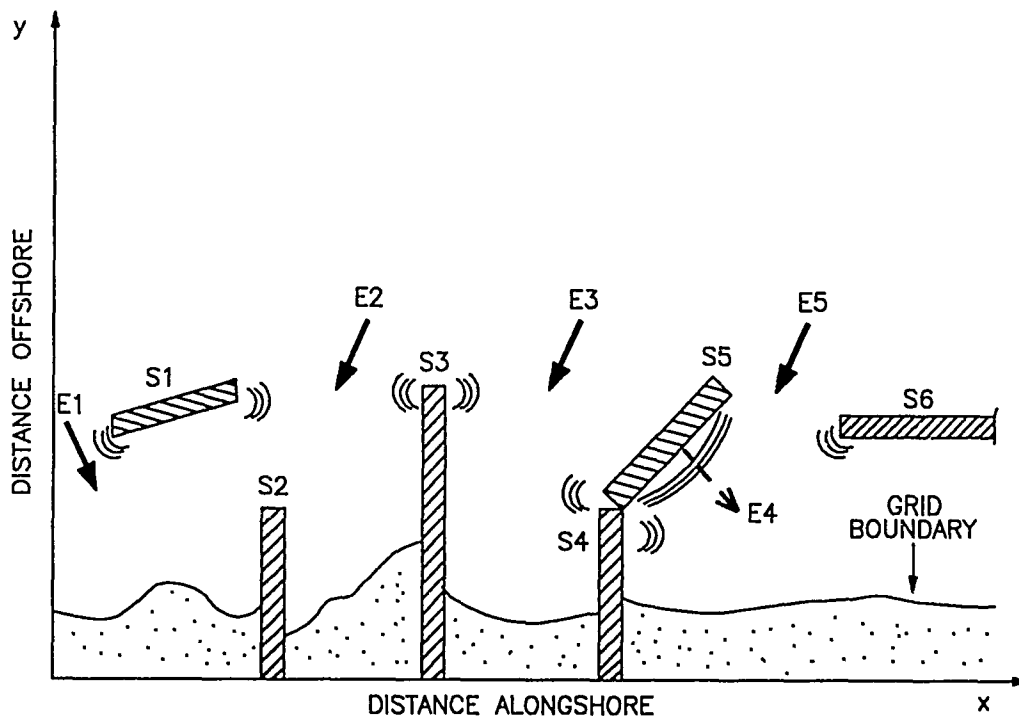

Figure 16. Energy windows and transport calculation domains

E1: This semi-infinite window is bounded only on the right side, the open sea being on the left side. Waves entering through E1 are diffracted by the left tip of structure S1. Waves entering through this window (or through window E2) cannot arrive at beaches to the right of structure S3 and, therefore, do not directly generate sand transport to the right of S3. Sand bypassing from left to right at S3 can occur, supplying a boundary condition to the transport domain defined by the region between S3 and S4.

S1: This detached breakwater has two diffracting tips, the left tip defining the right boundary of window E1 and the right tip defining the left boundary of window E2. The detached breakwater is nontransmissive and, therefore, not itself an energy window.

S2: The structure S2, a short groin, does not define an energy window since it does not produce diffraction; similarly, it does not define the boundary of a sand transport calculation domain but is merely located inside the transport domain extending from the left boundary of the grid to S3.

E2: This window is bounded by diffracting structures S1 and S3. Waves entering through this window can reach to the left boundary of the grid but cannot reach the beach segments to the right of S3. Window E2 is thus located inside the same transport domain as window E1, the transport domain defined by an open boundary on the left and tip S3 on the right.

S3: Because longshore sand transport is produced by breaking waves, only groins extending through the surf zone are considered to influence wave breaking by diffraction. The effect of shorter groins is confined to constraining the sand transport rate. In this example S3 is considered to be diffracting, and waves entering past one side of the structure cannot propagate to the other side. Structure S3 thus defines a boundary of a sand transport calculation domain.

E3: Waves entering through this energy window cannot propagate into the area on the left side of structure S3 or to the right of structures S4-S5.

S4 and S5: In GENESIS the two basic structure elements, the groin and one or more detached breakwaters, can be combined to create T-groins, half-Y groins, spur jetties, or even more complex configurations. Because S4 is connected to a detached breakwater, it must be regarded as being diffracting and, thus, also acts as a boundary of a sand transport calculation domain.

E4: In this example the structure segment S5 allows wave transmission, and waves arriving at the structure will pass through it but have diminished height. As a result, the structure S5 is also regarded as an energy window.

E5: Waves entering through this window can reach the right boundary of the grid, but cannot reach the beach segments to the left of S4.

S6: If the wave energy entering the project area from the right side of structure S6 can be neglected, the structure can be assumed to be infinitely

long. Then shoreline change to the right of S4-S5 is governed solely by wave energy entering through windows E4 and E5.

165. GENESIS will perform the shoreline calculation for the hypothetical project shown in Figure 16 by separating it into three sand transport domains: the beach from the left boundary to structure S3, the beach between structures S3 and S4-S5, and the beach from S4-S5 to the right boundary. Wave energy windows, breaking waves, and longshore sand transport rates are determined automatically by GENESIS for the three domains on the basis of the input data.

Multiple diffraction

166. If an energy window is bounded by two sources of wave diffraction, one on the left (L) and one on the right (R), each will have an associated diffraction coefficient, K_{DL} and K_{DR} , respectively. The internal wave model calculates a combined diffraction coefficient K_D for the window as

$$K_D = K_{DL}K_{DR} \quad (22)$$

as shown in Figure 17. If an energy window is open on one side, the diffraction coefficient for that side is set equal to 1.0.

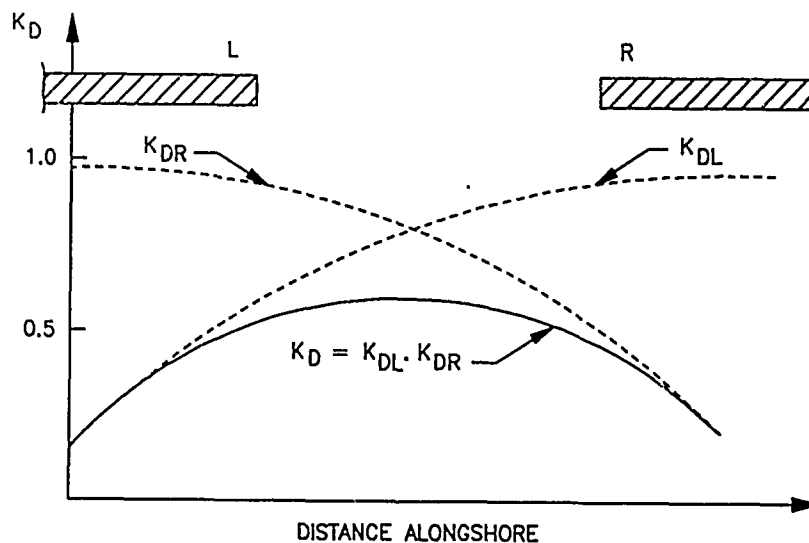

Figure 17. Diffraction coefficient for two sources

Numerical Solution Scheme

167. If all information is available to use Equation 1 (shoreline change equation), Equation 2 (longshore sand transport rate equation), and Equation 14 (wave breaking criterion), the response of the shoreline to wave action can be calculated. Under certain simplified conditions, closed-form mathematical solutions of Equation 1 can be found (see, for example, Larson, Hanson, and Kraus 1987), but in order to describe realistic structure and shoreline configurations, including waves that vary alongshore and with time, Equation 1 must be solved numerically. In a numerical solution procedure, the distance alongshore is divided into cells of a certain width (called the grid spacing), and the duration of the simulation is similarly divided into small elements (called the time step). If the grid spacing and time step are small, solutions of the governing partial differential equation (Equation 1) can be accurately calculated by numerical solution of the finite-difference equation.

Numerical and physical accuracy

168. Referring to Figure 6 and the shoreline change equation (Equation 1), the change in position of the shoreline can be mathematically written as

$$\Delta y = - \frac{\Delta t}{(D_B + D_C)} \frac{\Delta Q}{\Delta x} \quad (23)$$

in which ΔQ is the difference in longshore sand transport rates at the walls of the cell. In arriving at Equation 23, the contribution to Δy by line sources and sinks q was omitted for simplicity. Equation 23 indicates that the change in shoreline position Δy is directly proportional to Δt and inversely proportional to Δx (actually, Δy is inversely proportional to $(\Delta x)^2$, as described below).

169. Numerical accuracy refers to the degree to which the numerical scheme provides an accurate solution to the partial differential equation (Equation 1). Physical accuracy refers to the degree to which Equation 1 and the associated input data represent the actually occurring processes. Physical accuracy depends on the quality of the input data and the degree to

which the basic assumptions of shoreline change modeling approximate conditions at the site. Good numerical accuracy does not necessarily imply good physical accuracy. For a rapid numerical solution, the time step should be as large as possible. On the other hand, the numerical and physical accuracy will obviously be improved if the time step is small, since changes in the wave conditions and changes in the shoreline position itself (which feed back to modify the breaking waves) will be better represented. Similarly, use of many small grid cells will provide more detail or improved numerical accuracy in the shoreline change calculation than use of fewer but longer cells, but the calculation time will increase as the number of cells increases.

Numerical stability

170. The allowable grid spacing and time step of a finite difference numerical solution of a partial differential equation such as Equation 1 depend on the type of solution scheme. Under certain idealized conditions, Equation 1 can be reduced to a simpler form to examine the dependence of the solution on the time and space steps. The main assumption needed is that the angle θ_{bs} in Equation 2 is small. In this case, $\sin 2\theta_{bs} \approx 2\theta_{bs}$. By Equation 17, $\theta_{bs} = \theta_b - \partial y / \partial x$, since the inverse tangent can be replaced by its argument if the argument is small. The derivative of Q with respect to x is required (Equation 1 or Equation 23) and, under the small-angle approximation, $\partial Q / \partial x \sim \partial(2\theta_{bs}) / \partial x \sim 2\partial^2 y / \partial x^2$, if it is assumed that θ_b does not change with x . After some algebraic manipulation, Equation 1 (or Equation 23 rewritten as a partial differential equation) can be expressed as (Kraus and Harikali 1983):

$$\frac{\partial y}{\partial t} = (\epsilon_1 + \epsilon_2) \frac{\partial^2 y}{\partial x^2} \quad (24)$$

where

$$\epsilon_1 = \frac{2K_1}{(D_B + D_C)} (H^2 C_g)_b \quad (25)$$

and

$$\epsilon_2 = \frac{K_2}{(D_B + D_C)} \left[H^2 C_g \cos \theta_{bs} \frac{\partial H}{\partial x} \right]_b \quad (26)$$

As Equation 24 is a diffusion-type equation, its stability properties are well known. The numerical stability of the calculation scheme is governed by:

$$R_S = \frac{\Delta t(\epsilon_1 + \epsilon_2)}{(\Delta x)^2} \quad (27)$$

The quantity R_S is known as the Courant number in numerical methods; here it is called the stability parameter. The finite difference form of Equation 24 shows that $\Delta y \sim \Delta t/(\Delta x)^2$.

171. Equation 24 can be solved by either an explicit or an implicit solution scheme. If solved using an explicit scheme, the new shoreline position for each of the calculation cells depends only on values calculated at the previous time step. The main advantages of the explicit scheme are easy programming, simple expression of boundary conditions, and shorter computer run time for a single time step as compared with the implicit scheme. A major disadvantage is, however, preservation of stability of the solution, imposing a severe constraint on the longest possible calculation time step for given values on model constants and parameters. If an explicit solution scheme is used to solve the diffusion equation, the following condition must be satisfied (Crank 1975):

$$R_S \leq 0.5 \quad (28)$$

172. If an explicit solution scheme is used and the value of R_S exceeds 0.5 at any point on the grid, the calculated shoreline will show an unphysical oscillation that will grow in time if R_S remains above 0.5, alternating in direction at each grid point. The quantities ϵ_1 and ϵ_2 can change greatly alongshore since they depend on the local wave conditions. Assuming that the grid cell spacing is fixed by engineering requirements, a

large wave height would necessitate a small value of Δt . Although there are calculation strategies to overcome this problem, it is inefficient to use an explicit solution scheme to solve for shoreline position in a general case.

173. Equation 1, of which Equation 24 is a special case, can also be solved using an implicit scheme in which the new shoreline position depends on values calculated on the old, as well as the new, time step. The main advantage of the implicit scheme is that it is stable for very large values of R_S . The disadvantages of the implicit solution scheme are that the program, boundary conditions, and constraints become more complex, as compared with the explicit scheme. These disadvantages are, however, not considered to be major.

174. An implicit solution scheme is used in GENESIS to solve Equation 1, as developed by Kraus and Harikai (1983) based on a method given by Perlin and Dean (1978). Kraus and Harikai also showed for a specific example that the magnitude of the stability parameter gives an indication of numerical accuracy of the solution. Roughly speaking, for values of R_S less than 10, the numerical error equaled the magnitude of R_S expressed as a percentage. Above the value of 10, the error increased at a greater than linear rate with R_S . GENESIS calculates the value of R_S at each time step at each grid point alongshore and determines the maximum value. If $R_S > 5$ for any grid point, a warning is issued. The implicit finite difference scheme is discussed further below.

Grid System and Finite Difference Solution Scheme

Staggered grid

175. In GENESIS calculated quantities along the shoreline are discretized on a staggered grid in which shoreline positions y_1 are defined at the center of the grid cells ("y-points") and transport rates Q_1 at the cell walls ("Q-points"), as shown in Figure 18. The left boundary is located at grid cell 1, and the right boundary is at cell N. In total there are N values of the shoreline position, so the values of the initial shoreline position must be given at N points. There are N+1 values of the longshore sand transport rate since N+1 cell walls enclose the N cells; values of

the transport rate must be specified at the boundaries, Q_1 and Q_{N+1} , and the remainder of the Q_i and all y_i will be calculated. Since the Q_i are a function of the wave conditions, all wave quantities are calculated at Q-points. The tips of structures are likewise located at Q-points. Beach fills, river discharges, and other sand sources and sinks are located at y-points.

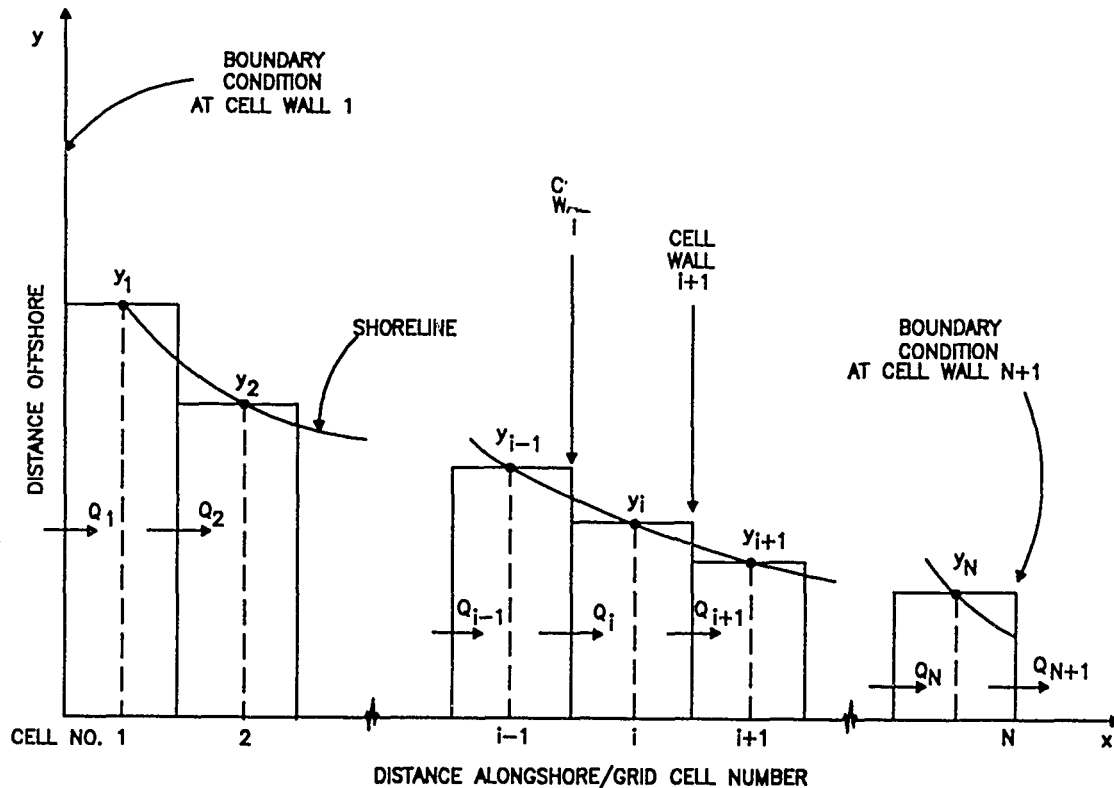

Figure 18. Finite difference staggered grid

Implicit finite difference solution scheme

176. In the following, a subscript i denotes a quantity located at an arbitrary cell number i along the beach. A prime ($'$) is used to denote a quantity at the new time level, whereas an unprimed quantity indicates a value at the present time step, which is known. The quantities y' and Q' are not known and are being sought in the solution process; other primed quantities such as q' and D'_B refer to data at the next time step and are known.

177. The Crank-Nicholson implicit scheme is used (Crank 1975) in which the derivative $\partial Q/\partial x$ at each grid point is expressed as an equally weighted average between the present time step and the next time step:

$$\frac{\partial Q_i}{\partial x} = \frac{1}{2} \left[\frac{Q'_{i+1} - Q'_i}{\Delta x} + \frac{Q_{i+1} - Q_i}{\Delta x} \right] \quad (29)$$

Substitution of Equation 29 into Equation 1 and linearization of the wave angles in Equation 2 in terms of $\partial y/\partial x$ results in two systems of coupled equations for the unknowns y'_i and Q'_i :

$$y'_i = B'(Q'_i - Q'_{i+1}) + yc_i \quad (30)$$

and

$$Q'_i = E_1(y'_{i+1} - y'_i) + F_i \quad (31)$$

where

$$B' = \Delta t / [2(D_B + D'_c)\Delta x]$$

yc_i = function of known quantities, including q'_i and q_i

E_1 = function of the wave height, wave angle, and other known quantities

F_i = function similar to E_1

178. The so-called double-sweep algorithm is used to solve Equations 30 and 31. Details of the solution procedure are given in Kraus and Harikai (1983), Hanson (1987), Hanson and Kraus (1986b), and Kraus (1988c).

Lateral Boundary Conditions and Constraints

179. GENESIS requires specification of values for Q at both boundaries, cell walls 1 and $N+1$, at each time step. The importance of the lateral boundary conditions cannot be overemphasized, as calculated shoreline positions of the interior of the grid depend directly upon them. The most ideal lateral boundaries are the terminal points of littoral cells, for

example, long headlands or long jetties at entrances and inlets. On the other hand, engineering structures such as groins or seawalls may be present on the internal domain of the grid. These barriers interrupt the movement of sand alongshore and so constrain the transport rate and/or movement of the shoreline. These constraints, which function similar to boundary conditions, must be incorporated in the simulation. In the following, commonly used boundary conditions are discussed.

Pinned-beach boundary condition

180. It is helpful to plot all available measured shoreline position surveys together to determine locations along a beach that might be used as model boundaries. In doing so it is sometimes possible to find a portion of the beach distant from the project that does not move appreciably in time. By locating the model boundary at such a section, the modeled lateral boundary shoreline coordinate can be "pinned." Expressed in terms of the transport rate, this means

$$Q_1 = Q_2 \quad (32)$$

if implemented on the left boundary, and

$$Q_{N+1} = Q_N \quad (33)$$

if implemented on the right boundary. These relations can be readily understood by reference to Equation 23; if $\Delta Q = 0$ at the boundary, then $\Delta y = 0$, indicating that y does not change. The pinned-beach boundary should be located far away from the project to assure that the conditions in the vicinity of the boundary are unaffected by changes that take place in the project. Details of the mathematical representation of this boundary condition in the double sweep algorithm are presented in Hanson (1987).

Gated boundary condition

181. Groins, jetties, shore-connected breakwaters, and headlands that interrupt, partially or completely, the movement of sand alongshore may be incorporated as a boundary condition if one is located on an end of the calculation grid. If located on the internal domain of the grid, these

objects will act to constrain the transport rate and shoreline change, automatically calculated by GENESIS. The representation is the same for both cases, although it occurs in different places in the numerical solution scheme.

182. The effect of a groin, headland, or similar object located on the boundary is formulated in terms of the amount of sand that can pass the structure. Consideration must be given to sand both entering and leaving the grid. For example, at a jetty located next to an inlet with a deeply dredged navigation channel, sand might leave the grid by bypassing the jetty during times of high waves; in contrast, no sand is expected to cross the navigation channel and jetty to come onto the grid. The jetty/channel thus acts as a selective "gate," allowing sand to move off but not onto the grid. This "gated boundary condition" was termed the "groin boundary condition" in previous descriptions of GENESIS.

183. The most appropriate mathematical representation of the gated boundary condition is a subject of active research (Gravens and Kraus 1989), and GENESIS is expected to undergo revision in this capability. At present two approaches are under study, one in which the amount passing the boundary is proportional to the transport rate at the immediately updrift grid cell (Perlin and Dean 1978) and the other in which the amount is proportional to the potential longshore transport rate at the location of the boundary (Hanson and Kraus 1980). In any case, the gating action on a boundary is controlled by the combined actions of sand bypassing and sand transmission.

184. Sand bypassing. In GENESIS, two types of sand movement past a structure are simulated. One type of movement is around the seaward end of the structure, called bypassing, and the other is through and over the structure, called sand transmission. Bypassing is assumed to take place if the water depth at the tip of the structure D_G is less than the depth of active longshore transport D_{LT} . Since the shape of the bottom profile is known (Equation 6), D_G is determined from knowledge of the distance between the tip of the structure and the location of the shoreline. However, since structures are located at grid cell walls between two calculated shoreline positions, this depth is not unique. In GENESIS the updrift depth is used.

185. To represent sand bypassing, a bypassing factor BYP is introduced and defined as

$$BYP = 1 - \frac{D_G}{D_{LT}} , \quad (D_G \leq D_{LT}) \quad (34)$$

implying a uniform cross-shore distribution of the longshore sand transport rate. If $D_G \geq D_{LT}$, $BYP = 0$. Values of BYP thus lie in the range $0 \leq BYP \leq 1$, with $BYP = 0$ signifying no bypassing, and $BYP = 1$ signifying that all sand can potentially pass the position of the structure. The value of BYP depends on the wave conditions at the given time step, since D_{LT} is a function of the wave height and period (Equation 4).

186. Sand transmission. A permeability factor $PERM$ is analogously introduced to describe sand transmission over, through, and landward of a shore-connected structure such as a groin. A high (in relation to the mean water level), structurally tight groin that extends far landward so as to prevent landward sand bypassing is assigned $PERM = 0$, whereas a completely "transparent" structure is assigned the value $PERM = 1$. Values of $PERM$ thus lie in the range of $0 \leq PERM \leq 1$ and must be specified through judgment of the modeler based upon, for example, the structural characteristics of the groin (jetty, breakwater), its elevation, and the tidal range at the site. Aerial photographs are often helpful in estimating a structure's amount of void space (hence $PERM$) in relation to other structures on the model grid. The optimal value of $PERM$ for each structure must then be determined in the process of model calibration.

187. With the values of BYP and $PERM$ determined, GENESIS calculates the total fraction F of sand passing over, around, or through a shore-connected structure as (Hanson 1987)

$$F = PERM(1 - BYP) + BYP \quad (35)$$

This fraction is calculated for each shore-connected (groin-type) structure defined on or at the boundaries of the grid.

Seawall

188. A seawall, or, in general, any shore-parallel nonerodible barrier such as a rocky cliff, imposes a constraint on the position of the shoreline because the shoreline cannot move landward of the wall. Hanson and Kraus (1985, 1986b) developed a procedure for calculating the position of the shoreline constrained by a seawall. The procedure is consistent with shoreline response modeling theory and has the following three properties:

- a. The shoreline in front of a seawall cannot recede landward of the wall.
- b. Sand volume is conserved.
- c. The direction of longshore sand transport at the wall is the same as that of the potential local transport.

GENESIS first calculates longshore sand transport rates along the beach based on the assumption that the calculated amount of sand is available for transport (the potential transport rate). At grid cells where the seawall constraint is violated, the shoreline position and the transport rate are adjusted. These quantities in neighboring cells are also adjusted, as necessary, to preserve sand volume and the direction of transport. The calculation procedure is complex, and the reader is referred to Hanson and Kraus (1986b) for full details. Flanking of the seawall is not possible since it would lead to a double-valued shoreline position at the same grid cell.

Beach Fill

189. Beach fill is a traditional and increasingly popular method of shore protection and flood control, and nourished beaches also have value for recreational, commercial, and environmental purposes. Fill is commonly placed together with the building of coastal structures such as groin fields and detached breakwaters. GENESIS is capable of representing the behavior of fills under the following assumptions:

- a. The fill has the same median grain size as the native sand.
- b. The profile of the fill represented in the model has the equilibrium shape corresponding to its grain size.
- c. The berm height of the nourished beach is the same as the natural beach.

These assumptions are necessary since the transport parameters, shape of the equilibrium beach profile, and berm height are considered constant for the entire beach being simulated.

190. Although beach fills are constructed with a certain cross-sectional area, after a certain time period, typically on the order of a few weeks to months, the fill will be redistributed by wave action to arrive at the equilibrium shape of the beach. As a shoreline response model, GENESIS interprets any added width of beach as conforming to the equilibrium shape. For implementation of fill in GENESIS, the modeler must compute the total added distance Y_{add} that the shoreline will be advanced. This distance is known since the total volume of the fill equals the product of the depth of closure plus berm height, alongshore length of the fill, and Y_{add} . The modeler must estimate if it is appropriate to remove a percentage of the total fill volume that may be lost in fines. Such material is believed to be carried offshore and out of the littoral system. GENESIS places the amount of Y_{add} on the beach in equal increments Δy of shoreline advance along the specified length of the project per time step over the user-specified construction period of the fill. The amount Δy is added whether the waves are calm or active.

191. The input change in shoreline position can also be negative, resulting in shoreline recession instead of advance. This option is useful for describing sand mining. In this case, the shoreline cannot recede landward of a seawall.

Longshore Transport Rate: Practical Considerations

192. The empirical formula used to calculate the longshore sand transport rate in GENESIS is given by Equation 2. The transport rate is obtained as a function of the waves and shoreline/contour orientation at each time step and at each grid point, except at pinned-beach boundaries. In this section three important considerations are discussed which involve quantities composed of transport rates as calculated from Equation 2. The topics usually encountered in practical applications are:

- a. Multiple transport rates as produced by multiple wave sources.

- b. Derived transport rates (net and gross transport rates).
- c. Effective threshold for longshore sand transport (calm and near-calm wave events).

The first two items are treated within GENESIS in combination with appropriate input file preparation, and the third item is treated in wave data file preparation prior to running GENESIS.

Multiple transport rates

193. Waves arriving at the shore are typically produced by several independent generating sources. Long-period swell waves were probably generated from distant storms, whereas the shorter period "chop" or sea waves were produced by local winds. Indeed, the WIS hindcast provides information for both sea waves and swell. The modeler may have to deal with even more than two wave sources. For example, for the southern coast of California, three independent wave sources coexist during parts of the year: Northern Hemisphere swell, local sea waves, and the Southern Hemisphere swell which arises from storms as far away as the Antarctic Ocean. The Southern Hemisphere swell occurs mainly in the interval from May through October and, in some years, may be the dominant transporting wave component along the coast of the southern California Bight.

194. The situation of multiple wave sources is handled through the assumption that each wave source gives rise to an independent longshore sand transport rate. GENESIS then calculates a total longshore sand transport rate at each grid point i by linear superposition. Let $Q_{i,m}$ be the transport rate at grid point i produced by source m , of which there are M wave sources. The total transport rate at i is

$$Q_i = \sum_{m=1}^M Q_{i,m} \quad (36)$$

GENESIS uses this quantity to calculate shoreline change.

195. As discussed in the next chapter, the interface of GENESIS requires specification of the number of wave sources (called "NWAVES" instead of M as above). The file holding wave data must similarly reflect this number by containing wave data in sequence for the M sources at each

time step. On the basis of this information, GENESIS calculates Q_i at each time step, automatically accounting for the placement of beach fills, skipping over wave data for calm events, and performing other "book-keeping" tasks that depend on the time step in combination with the number of wave sources. Each wave source increases computation time of the modeling system.

Derived transport rates

196. In shoreline change modeling, it is convenient to analyze long-shore sand transport rates and shoreline change from the perspective of an observer standing on the beach looking toward the water. Two directions of transport can then be defined (SPM 1984, Chapter 4) as left moving, denoted by the subscripts lt , and right moving, denoted by the subscripts rt . The corresponding rates Q_{lt} and Q_{rt} do not have a sign associated with them, i.e., they are intrinsically positive; information on transport direction or sign is contained in the subscripts. Use of these two rates is convenient for two reasons: first, the terminology is independent of the orientation of the coast and, therefore, provides uniformity and ready understanding independent of the coast; second, the awkwardness of dealing with the sign is eliminated. Two other very useful rates entering in engineering applications can be defined in terms of these basic quantities, the gross transport rate and the net transport rate.

197. The gross transport rate Q_g is defined as the sum of the transport to the right and to the left past a point (for example, grid cell i) on the shoreline in a given time period.

$$Q_g = Q_{rt} + Q_{lt} \quad (37)$$

A navigation channel at a harbor or inlet and a catch basin adjacent to a jetty will trap sand arriving from either the left or the right. This quantity is estimated by computing the gross transport rate.

198. The net transport rate Q_n is the difference between the right- and left-moving transport past a point on the shoreline in a given time period. It is defined as

$$Q_n = Q_{rt} - Q_{lt} \quad (38)$$

The net rate is a vector sum of transport rates and is the quantity needed to determine whether a section of coast will erode or accrete. The rates Q used by GENESIS to compute shoreline change through differences in transport rates alongshore are net rates.

Effective threshold for transport

199. Inspection of Equation 2 for the longshore sand transport rate shows that the first and dominant term has a dependence on breaking wave height and direction as

$$Q \sim (H_b)^{5/2} \sin 2\theta_{bs} \quad (39)$$

since the wave group speed at breaking is $C_{gb} \sim (H_b)^{1/2}$. Consider two breaking waves, one with height of 1 m and the other of 0.1 m, which have the same angle at breaking. By Equation 39, the 1-m wave will have a transport rate 300 times greater than the 0.1-m high wave. For the same wave period and deepwater direction, a higher deepwater wave will break at a larger angle, also increasing the disparity in magnitudes of transport rates associated with high/low waves and large/small deepwater wave angles.

200. A coast open to the ocean will experience a range of wave conditions from completely calm to stormy. Because of the great amplification of the longshore transport rate through the wave height and, to a lesser extent, wave angle, it is reasonable to apply a cutoff or threshold to eliminate from the times series wave conditions that have negligible transport rates and are not significant factors contributing to shoreline change.

201. Empirical evidence for an effective threshold of longshore sand transport was found by Kraus and Dean (1987), later revised by Kraus, Gingerich, and Rosati (1988), based on sand trap measurements in the field for a sand of nominal grain diameter of 0.2 mm. Komar (1988) made a comprehensive study on the physical controls on the longshore sediment transport rate and concluded there is no empirical evidence that the rate depends on the grain size for typical beach sands. This result implies that the criterion found by Kraus, Gingerich, and Rosati should apply to any sandy coast. Kraus, Hanson, and Larson (1988) developed a method for applying this threshold to eliminate in an objective manner wave events that would produce negligible longshore

transport. In specific examples using hindcast and measured wave data, they showed that in a certain case for the Atlantic coast of the United States as much as 86 percent of the waves could be considered as effectively calm, eliminating the necessity for performing the shoreline change calculation at the particular time step in which they appear in the time series.

202. The procedure is applied by scanning the wave time series and propagating waves to breaking by assuming plane and parallel bottom contours. A modified time series of deepwater wave conditions is then developed in which waves not satisfying the threshold criterion described below are made to indicate a calm condition, accomplished by either setting the value of the wave height to zero or the wave period to -999. In reading such a value, GENESIS will move to the next wave condition if there are multiple waves per time step or to the next time step, not executing the transport rate calculation and, possibly, not performing the shoreline change calculation if there are no effective waves in the given time step.

203. The cutoff for effective longshore sand transport is given as

$$H_b X_b V = 3.9 \quad (\text{m}^3/\text{sec}) \quad (40)$$

where

X_b = width of the surf zone (distance between shoreline and breaker line)

V = mean speed of the longshore current

For the purpose here, using $X_b \approx D_b/\tan\beta$ and Equation 14 ($H_b = \gamma D_b$), the width of the surf zone can be expressed as $X_b = H_b/(\gamma \tan\beta)$. For V , Komar and Inman (1970) empirically found that $V = 1.35(H_b/2)(\gamma g/H_b)^{1/2} \sin 2\theta_{bs}$ for the situation of the longshore current generated by obliquely incident waves. Substitution of these expressions for X_b and V into Equation 40 gives a formula that can be used with a simple wave transformation program to test for noneffective longshore transport conditions:

$$H_b^{5/2} \sin 2\theta_{bs} = \frac{2(3.9)}{1.35} \frac{\gamma^{1/2} \tan\beta}{g^{1/2}} \quad (41)$$

If the value of the left side of Equation 41 is less than or equal to the threshold value on the right, then that wave condition in the deepwater time series can be designated as calm. The GENESIS Workbook provides a program for prescanning time series wave data for satisfaction of the threshold longshore transport criterion. Note that Equation 41 is valid for metric units. If American customary units are used, the empirical value of $3.9 \text{ m}^3/\text{sec}$ should be changed to $138 \text{ ft}^3/\text{sec}$. These values are expected to be revised as more field data become available.

PART VI: STRUCTURE OF GENESIS

204. This chapter describes the general structure and operation of the user interface of GENESIS and the preparations that must be made prior to running the modeling system. Discussion is focused on the input and output files comprising the interface. This and the succeeding two chapters provide practical information needed to run GENESIS.

205. The predictive reliability of GENESIS depends on the quality of the input data. A major portion of the shoreline change simulation effort involves gathering, cleaning, interpreting, formatting, and entering data into input files. The various types of data used by GENESIS are discussed in Part V. In a scoping application, data preparation and model setup typically take 1 to 2 months, depending on the scale of the project; the time for model preparation and setup for design studies is typically 2 to 6 months.

Preparation to Run GENESIS

Coordinate system and grid

206. As discussed in Part V, a coordinate system and grid are laid out on a nautical chart or aerial photographs covering the region of the project, and measured shoreline positions, locations and configurations of structures and beach fills, and other topographic and geometric information are expressed in the coordinate system as a function of grid cell number alongshore and distance offshore. Alongshore location is specified by grid cell number rather than distance in order to allow the precise control of positioning. The grid is discretized alongshore (along the x-axis), whereas shoreline positions and other quantities specified along the y-axis are continuous. Length units can be selected as either meters or feet, and all input and output will use those units.

207. A schematic example of the coordinate system and a grid is shown in Figure 19. The vertical scale is exaggerated since the longshore extent covered is typically thousands of meters or feet, whereas shoreline change is typically tens or hundreds of the corresponding units. In shoreline applications, such figures are drawn with the observer positioned on land and the

boundaries to the left and right, as described in Part V. Notation used in this figure is also described in Part V.

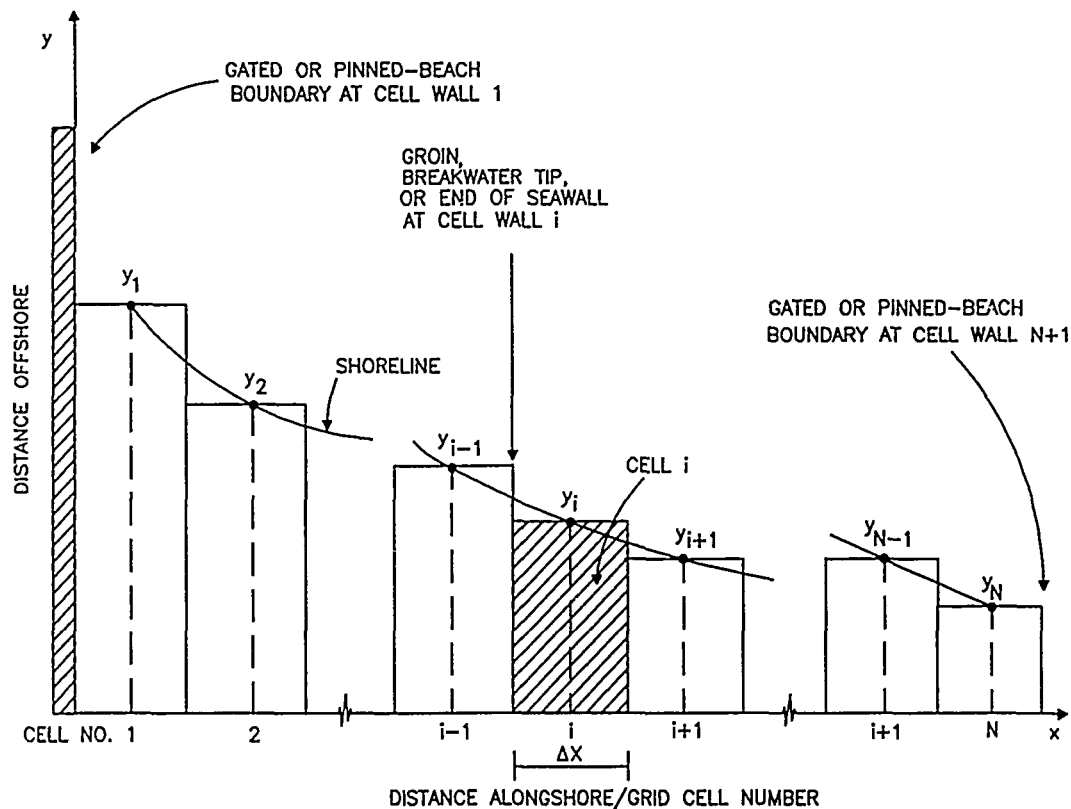

Figure 19. Example of a coordinate system and grid used by GENESIS

208. A right-hand coordinate system is drawn with the x-axis (baseline) parallel to the trend of the shoreline and the y-axis perpendicular to it and pointing offshore. It is convenient to place the baseline landward of coastal structures and any expected or historical position of the shoreline so as to deal with only positive-valued shoreline positions, although this need not be the case. The shoreline grid along the x-axis consists of N cells defined by $N+1$ cell walls. Boundary conditions must be specified at cell walls 1 and $N+1$. Internally in GENESIS, longshore sand transport rates, positions of structures, and boundary conditions are located at cell walls, and shoreline positions are located in the middle of cells. Cell wall 1 is placed at the location where the left boundary condition is implemented, and the grid

cell spacing should be determined such that major shoreline features are resolved. Distances are read on the grid with cell wall 1 as the origin; that is, the y-axis intersects the x-axis at grid wall 1, not at "zero."

209. GENESIS Version 2 uses a uniform alongshore grid, and the spacing between all shoreline positions is Δx . Positions on the grid defining the ends of structures, of which terminal groins or jetties are a typical case, are located at a distance $\Delta x/2$ from adjacent shoreline position cells, since sediment transport rates are calculated at grid cell walls. In the example of Figure 19, a tip of a detached breakwater (groin, seawall) is assigned to position i ; GENESIS will place the tip of the structure at cell wall i and not at shoreline position i , which is in the middle of the cell. As another example, the jetty located on the left boundary of the grid is a distance $\Delta x/2$ to the left of shoreline position coordinate y_1 ; the shoreline starts at the location of y_1 , not at the jetty. Concerning beach fills, since a fill moves the position of the shoreline, the grid locations of the two lateral ends of a fill are at shoreline positions, not cell walls.

210. All historic shoreline position data must be translated to the coordinate system and placed on the grid. Structures are usually assigned the cell number at which they would naturally reside, but the modeler is free to use judgment. For example, if an already short detached breakwater would be further shortened by following standard procedure in placing it on the grid (due to roundoff to the nearest cell position), one tip could be "moved" to the next cell to increase the effective length of the structure.

211. It is also possible to simulate shoreline change along a subsection of the grid, in which case consideration must be given to boundary conditions at the two ends of the subsection. It is recommended to check the results of preliminary model runs for longshore and offshore locations of topographic information to confirm that it was entered correctly on the grid.

Lateral boundary conditions

212. As described in Part V, GENESIS allows two types of lateral boundary conditions to be implemented, a "gated" boundary and a "pinned-beach" boundary. The default condition is the pinned beach; if a groin is not placed on cell wall 1 or $N+1$, the boundary will be treated as a pinned beach, allowing sand to freely cross it from both sides.

213. Gated boundary. A gated boundary condition (Figure 20) is implemented at a terminal grid cell (grid cell walls 1 and N+1) if the modeler specifies a groin (or jetty or shore-connected breakwater) in the respective cell. The amount of sand entering or leaving the grid at a gated boundary is determined by the distances from the shorelines on either side of the groin to the seaward end of the groin, the beach slope at the groin, and the permeability of the groin. In Figure 20, the distance from the shoreline to the end of jetty outside the grid on the right boundary y_{GN} was made very long (as specified in the model input) and the permeability set to 0. (Such a condition might occur if an inlet is located to the right of the grid.) The jetty therefore appears infinitely long and high from outside the grid on the right, and no sand will be transported onto the grid. However, transport off the grid at the right boundary may occur and will depend on the distance from the shoreline to the end of the jetty inside the grid and the wave conditions (which determine the depth and location of the longshore sand transport).

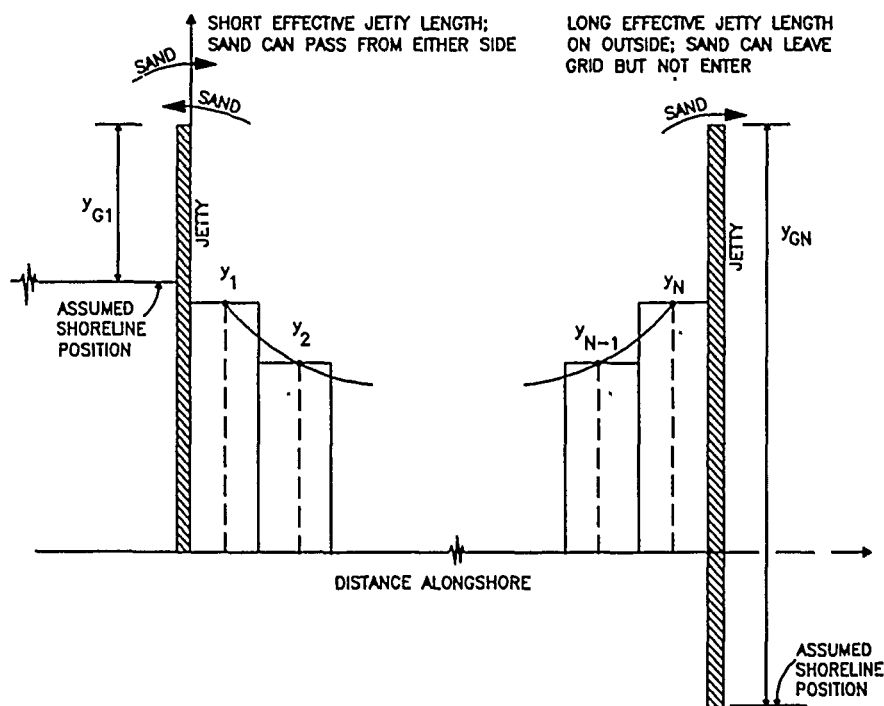

Figure 20. Gated boundary condition

214. On the left boundary of the grid in Figure 20, the jetty of the same length as that on the right boundary may allow sand to enter as well as leave the grid since its effective length on the outside y_{G1} was made comparatively short. The gated boundary condition thus allows considerable flexibility to control the rate of sand transport across the boundaries.

215. Pinned-beach boundary. The pinned-beach boundary condition represents a beach that has exhibited a long-term trend of stability. This condition is implemented as a default boundary condition. A pinned-beach boundary can be used in situations where a long sandy beach is located far from the project and has not or is not expected to change greatly in position.

216. The four possible combinations of the lateral boundary conditions are illustrated in Figure 21. The boundary conditions are independent and represent the modeler's interpretation of the physical situation. For small projects, pinned-beach boundaries are sometimes used and placed far from the project (for example, five project lengths to each side). The independence of the result on this distance should be checked by varying the distance. Care must be taken if the simulation interval is long or the transport intense.

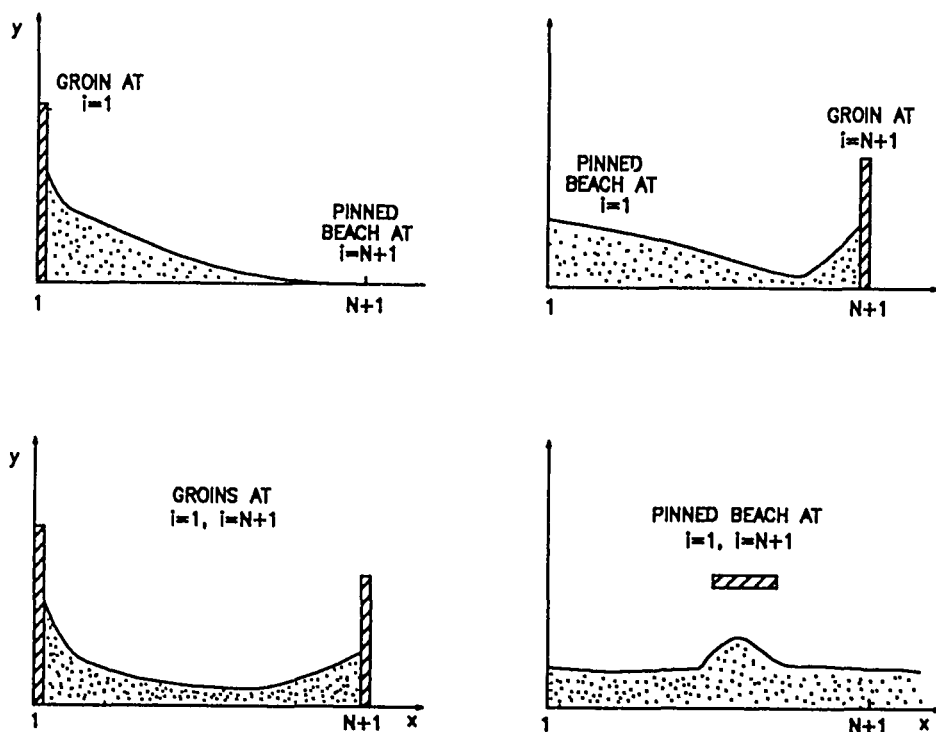

Figure 21. Combinations of lateral boundary conditions

Input Files

217. GENESIS is operated through use of six input data files, as illustrated in Figure 22. Input and output file names consist of five letters with the three-letter extension ".DAT." Input files contain the modeler's conceptualization of the project site, the factors that influence shoreline change from the perspective of shoreline change modeling, and data and technical information to run the simulation. GENESIS reads the input files and performs the shoreline change simulation according to the instructions and data contained in them. The present chapter deals in great part with the content and preparation of the input files.

218. Appendix B contains blank copies of input files that may be photocopied for use in projects or in working through the case study presented in Part VIII. Segments of START files, the main interface file for running GENESIS, are given in Part VII in discussion of examples.

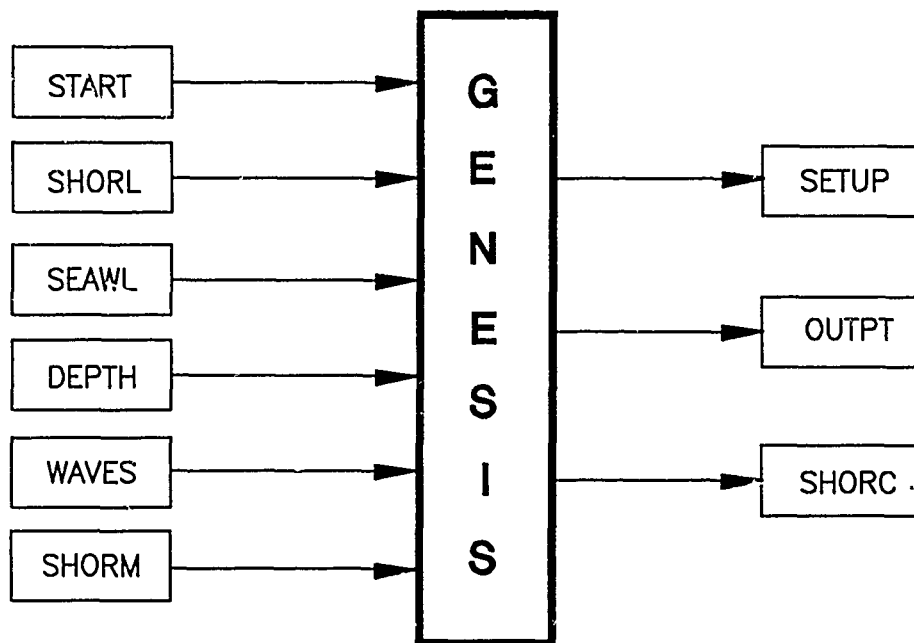

Figure 22. Schematic of input and output file structure of GENESIS

219. All input files begin with four header lines, and GENESIS skips over these when the files are read. The header lines are available to the user for documentation purposes, for example, to give the name of the file and title of the run, describe the format of the data contained in the file, and note any special conditions associated with the data or run. Whether or not these lines are used, exactly four "dummy" lines must appear in the header of every input file. If the four header lines are not present, GENESIS will either begin reading data at an incorrect position with a possible undetected computation error or give a runtime error that will be very difficult to trace, since the false data may cause a program crash at an arbitrary line of code.

220. The six input files which GENESIS will look for when it is executed are named START.DAT, SHORL.DAT, SEAWL.DAT, DEPTH.DAT, WAVES.DAT, and SHORM.DAT. Of these files, START, SHORL, WAVES, and SHORM are always required, whereas SEAWL and DEPTH may or may not be called by GENESIS, depending on instructions entered by the user in the START file. These files are discussed below, and examples of file preparation are given in Parts VII and VIII.

221. The aforementioned names are exactly those used by GENESIS. A project, however, may require many versions of the input files, particularly START files, since these files contain most of the information specifying project alternatives. As an example of a very simple situation involving multiple START files, if only two alternatives are considered in a project, detached breakwaters as one alternative and groins as the other, the modeler would probably construct two START files, possibly named START_BW and START_GR. When he or she is ready to run GENESIS for the detached breakwater alternative, the file START_BW would be copied into START.DAT. Later, when the groin alternative is to be run, START_GR would be copied into START.DAT. The various start files employed can be saved under their original names together with the output to document the process of evaluating the alternatives and results. Different START files are also needed in the calibration and verification procedure.

START

222. The input file START.DAT contains the instructions that control the shoreline change simulation and is the principal interface between the modeler and GENESIS. Once a generic START file for a project is prepared, typically only a few quantities in it will need to be changed during the course of verification, sensitivity testing, design optimization, etc.

223. Figure 23 shows an example of a START file. The START file contains requests for information in a series of lines arranged in sections according to general subject. Lines of text (the request portion) should be neither added nor deleted from the START file, as GENESIS will skip over these request lines to read the input values. Also, the line request identifier letter (A.1, B.1, C.1,...) should not be moved from column 1, as GENESIS looks for it there. However, the number of lines holding values in response to a specific request is arbitrary. Unless instructed otherwise, a response (an alphanumeric character) must be given to a request. If several values are required, they may be separated by a space or by a comma, or both.

224. Names of internal variables, particularly values that will be used to dimension arrays, are given in parentheses in the requests. To aid as a reference in using this manual, the key variable associated with the request is given at the start of each paragraph below. These names also appear in error messages and are needed when discussing START file configurations with others.

A. Model setup

225. Line A.1: TITLE . The first line of the START file requests a project title, which may be up to 70 characters long. The title line normally contains descriptive information about the particular run, for example, "ILLUSTRATIVE EXAMPLE FOR MANUAL" or "LAKEVIEW PARK: CALIBRATION RUN."

226. Line A.2: ICONV . The variable ICONV is a flag telling GENESIS the length units of the calculation. Calculations are performed by using either meters or feet, as selected at Line A.2. All length, height, and depth inputs, including wave height, water depths, seawall positions, etc., must be given in the specified units, and output will similarly be expressed

in these units. (The only exception is median grain size diameter on Line C.1, which must be given in millimeters.)

227. Line A.3: NN , DX . The total number of calculation cells NN (called "N" in the text of this report) and the cell length DX (called "Δx") are entered here. The product NN·DX gives the total length of the modeled reach.

228. Line A.4: ISSTART , N . This request allows the user to perform simulations over a portion of the grid through specification of starting and ending grid cells (boundaries) other than 1 and N+1 , respectively. This option is useful if a long grid has originally been prepared but, in a particular application, details of shoreline change along a subsection are to be studied. It is cautioned that the numbers of the starting cell ISSTART and ending cell N of the subsection grid must be located in physically reasonable areas for meaningful results to be obtained. In almost all circumstances, lateral boundaries should be placed either at a long groin or jetty or at a historically stable section of coast. It is recommended that this option not be exercised until experience is gained running GENESIS. If simulation of shoreline change in a subsection is not performed, the values of ISSTART and N should be 1 and NN (as specified on Line A.3), respectively. By setting N equal to -1 , GENESIS will set N equal to NN , and the value of N does not have to be changed for each new application.

229. Line A.5: DT . For a specific simulation interval, smaller values of the duration of the time step DT (called "Δt" in the main text of this report) increase the computational run time, whereas larger values of DT result in a less accurately predicted shoreline position. A time step of 6 hr is recommended for design, but longer time steps may be used, for example, 24 hr, depending on the variability of the input waves. Scoping applications will typically use a long time step (on the order of 24 hr). The wave data input file (WAVES) must be designed to provide wave data at the specified time step. To satisfy this requirement, DT must be a proper fraction (e.g., 1/2, 1/4) of the time step DTW defining entries in the wave file (Line B.6).

230. Line A.6: SIMDATS . The date when the calculation starts SIMDATS is needed to key GENESIS for selecting the correct season of waves,

coordinating beach fills, and entering changes in structure configurations. The input format is defined as a six-digit number, with two digits each representing the year (YY), month (MM), and day (DD) in that order, i.e., YMMDD. A full six-digit number must be specified for proper starting of the WAVES file.

231. Line A.7: SIMDATE . The simulation interval can be specified in terms of either the number of time steps or the date SIMDATE in simulation time. During testing and scoping, for which the model is run for only a few time steps, it is convenient to use the number of time steps. In design mode the dates of measured shorelines are known, and it is convenient to work in simulation time. GENESIS distinguishes time step and date input through the magnitude of the value of SIMDATE ; if SIMDATE is greater than or equal to 180,000, GENESIS will interpret it as a date, whereas if the value is smaller than 180,000, GENESIS will interpret it as the number of time steps.

232. Line A.8: NOUT . In many situations it is very informative to study the time evolution of the calculated shoreline change. For example, in design mode, for which simulations are made over several years, the shoreline location at the end of each month or each year may be desired. The value entered here NOUT specifies the total number of simulated times when output should be written to file (OUTPT.DAT, discussed below). The output of data at the final time step does not have to be included, since it is a default output.

233. Line A.9: TOUT(I) . Output may be specified by either the number of time steps or the corresponding dates in simulation time. The number of outputs TOUT(I) (time steps or dates) specified must match the number entered on Line A.8.

234. Line A.10: ISMOOTH . The representative contour used in the internal wave calculation is calculated through an alternating direction moving average algorithm. The variable ISMOOTH specifies the size of the moving window over which the average is calculated. If ISMOOTH is set equal to 0 , no smoothing is performed, and the representative contour will follow the shoreline. If ISMOOTH is set to N , the representative contour will be a straight line parallel to one drawn between the two end points of the shoreline.

235. Line A.11: IRWM . The variable IRWM allows the user to suppress printout of repeated warning messages (see the section "Error and Warning Messages"). For example, if a preliminary or scoping analysis is being performed with a long time step, the value of the stability parameter STAB (called R_s in the main text) is likely to exceed 5.0, and a warning message will be issued at every time step. If IRWM is set equal to zero, only one warning message will be given, and the screen and output file SETUP will not be cluttered with warning messages. In planning and design applications, the modeler will want to be aware of potentially undesirable conditions and should set IRWM = 1 .

236. Line A.12: K1 , K2 . Values of the longshore sand transport calibration coefficients K1 and K2 (called " K_1 " and " K_2 " in the main text) require adjustment in the process of model calibration. For sandy beaches experience has shown that values are typically in the ranges of $0.1 < K1 < 1.0$ and $0.5K1 < K2 < 1.5K1$. Initial trial runs might use $K1 = 0.5$ and $K2 = 0.25$. The transport parameter K1 controls the time scale of the calculation and is the principal calibration coefficient in GENESIS. Further discussion is given in Part V. (Note: the above-mentioned values of K1 and K2 correspond to rms wave height. Significant wave height should be entered in the WAVES file, however, as GENESIS automatically converts heights in the wave file from significant to rms.)

237. Line A.13: IPRINT . A computer program, in this case GENESIS, can be executed in two ways on most mainframe computers, by interactive mode (sometimes called demand mode) and by batch mode. In interactive mode, instructions are entered from the keyboard and reproduced on the monitor or printer; in this mode the terminal launching the job is devoted fully to execution of the program. In batch mode, the job is launched through a batch file devised by the user. The batch file contains commands and other data required to run the program and acts as a substitute for entries made at the keyboard. A job launched in batch mode will execute in the background and free the user's terminal for other applications. If GENESIS is executed in interactive mode, through IPRINT a counter can be requested to appear on the screen to show the time step presently being executed. The counter will be updated without causing the screen to scroll. If the counter is activated in

batch mode, one line will be printed in the default "log" file at each time step. The time step counter is activated by setting IPRINT = 1 and suppressed by setting IPRINT = 0 .

B. Waves

238. Line B.1: HCNGF , ZCNGF , ZCNGA . The wave height change factor HCNGF multiplies the wave height along the reference line (or multiplies the deepwater wave height if the internal wave model in GENESIS is used; see Line B.3). The wave angle change factor ZCNGF performs a similar operation on the wave angle. The wave angle amount ZCNGA is added to (or subtracted from, if negative) wave angles along the nearshore reference line (or from the deepwater wave angle if a nearshore reference line is not used). The change parameters allow quick answers to be obtained to scoping questions such as "What if the waves are 20 percent higher" or "What if the waves arrive from 5 deg farther out of the east than the hindcast indicates?" In order to run with the original, unchanged wave input (the normal situation), the value of the wave height change factor is 1.0, the wave angle change factor is 1.0, and the wave angle change amount is 0.0.

239. Line B.2: DZ . The depth of the offshore wave input DZ is required in order to refract waves to breaking. This depth corresponds to the depth at which waves originated if a refraction model was used to bring waves to a nearshore reference line or the depth of the input time wave record if a refraction model was not used, as specified on Line B.3.

240. Line B.3: NWD . The value specified for the flag NWD determines whether the waves will be refracted internally by GENESIS from the wave data contained in the input file WAVES.DAT (in which case NWD = 0 and the input wave data correspond to an offshore location) or if the file WAVES already holds wave information along the nearshore reference depth line (NWD = 1), in which case a refraction routine (for example, RCPWAVE) has already been used to bring waves to relatively shallow water.

241. Line B.5: ISPW . For simulations covering large spatial extent, it may not be computationally feasible to run the wave refraction model using the same (relatively fine) spatial alongshore resolution as that specified in GENESIS. By setting ISPW to an integer greater than unity, the size of the

wave calculation cells alongshore will be a multiple of the cell length used by GENESIS.

242. Line B.6: DTW . In situations where the temporal resolution of the available wave data is not as great as the time step DT to be used in the simulation, it is possible to run GENESIS with repeated wave conditions at each time step, as specified by the variable DTW . As an example, suppose wave data are only available at 24-hr intervals, but the model is to be run at the standard 6-hr time step to maintain numerical accuracy and/or stability; then by specifying DTW = 24 on line B.6 (and DT = 6 on line A.5), each set of wave conditions in the WAVES file will be run four times. Repetition of wave data is also used in the modeling of simple hypothetical cases in which constant wave conditions may be acceptable throughout the entire simulation; DTW can be set to be equal to or greater than the total simulation time in hours determined by the values specified at Lines A.5 through A.7. Then the first wave condition in the WAVES file will be run at every step.

243. Line B.7: N WAVES . The variable N WAVES provides the number of independent wave sources per step. Wave measurements often show two or more spectral peaks, indicating the presence of distinct wave trains. For example, swell may arrive from a distant storm, whereas sea waves are generated by local winds. These two types of waves are independent and will have different heights, periods, and directions. Also, WIS provides sea and swell components separately. GENESIS allows input of an arbitrary number of wave components. These are treated independently, with each component generating a longshore sand transport rate. The transport rates from each wave component at a given time step are added linearly, including sign, to give the net transport rate at that time step.

244. As another situation in which an extra wave component might enter a simulation, a long jetty may reflect a significant portion of the incident wave energy. If reflected waves are believed to appear in the breaking wave climate and influence shoreline evolution in the area, a time series of these waves may be included as a component in the WAVES file.

245. Line B.8: WDATS . The starting date of the shoreline change simulation was given at Line A.6. From the date of the start of the wave file WDATS entered at the present line, GENESIS determines the location in the

WAVES file corresponding to the start of the simulation. In most verifications and in all predictions, contemporaneous measured wave data do not exist for the simulation interval, and the input file WAVES is viewed as holding representative wave data for a number of typical years. Therefore, it is the number of years, starting from a particular month and day (season) that is usually important, not the actual date of the year. Simulation results for a beach fill placed in late spring or early summer will probably be much different than if the fill were placed under stormy winter waves. By beginning the simulation at the appropriate month and day, the phase of seasonality is preserved. It is a happy day in a modeler's life if gage or hindcast wave data are available over the full calibration or verification interval. If so, these data should be used.

246. The modeler will normally specify the date of the start of the WAVES file (i.e., WDATS) such that the simulation will begin at the first month and day occurring in that file. If it is desired to start the simulation in a year other than the first year appearing in the WAVES file, then the starting date of the WAVES file should be changed to move the starting pointer to the required year, month, and day. As a specific example, if the modeler wants to start the simulation in the second year of the wave data set rather than the first year, the starting date of the WAVES file should be set to one year later. The effect of seasonality in the wave data on shoreline response can be investigated by starting the WAVES file in different months.

C. Beach

247. Line C.1: D50. GENESIS uses the median diameter of the sand D50 (called " d_{50} " in the main text) to compute an equilibrium profile shape. The profile shape determines the distance from the shoreline to the point of wave breaking at each grid cell and hence the effective zone of longshore sand transport. The location of breaking also determines whether diffraction will take place, as sources of diffraction must lie seaward of the breaker zone. Figure 7 can be consulted for selecting an appropriate value of d_{50} .

248. Line C.2: ABH. The average berm height ABH (called " D_B " in the main text) above the mean water level or the datum used in the modeling is entered here.

249. Line C.3: DCLOS . The closure depth DCLOS (called "D_c" in the main text) defines the seaward limiting depth of profile movement. It is entered here, referenced to the same datum as the average berm height.

D. Nondiffracting groins

250. The lengths of groins and short jetties are normally on the order of the average width of the surf zone; wave diffraction produced by such structures can be considered to be negligible, since in shallow water the waves will arrive almost normal to the tip of the structure or will have already broken. Thus, typical groins used for shore protection and short jetties should be treated as nondiffracting structures.

251. GENESIS distinguishes between groins (and jetties) that produce or do not produce wave diffraction. Model computation time associated with a diffracting structure is much greater than for a nondiffracting structure; therefore, the number of diffracting groins should be minimized. The diffraction option, starting at Line E.1, is mainly used to describe long jetties (jetties with lengths on the order of several surf zone widths) and harbor breakwaters that act as a long jetty by almost completely blocking longshore sand transport; these types of structures extend well beyond the surf zone where waves may arrive at a large oblique angle, resulting in a wide diffraction zone. They also block sand transport alongshore and, therefore, are functionally equivalent to groins with regard to shoreline change.

252. GENESIS can accommodate a large number of simple groins and more complex structural configurations composed in part of simple groins. Part VII gives examples of START file instructions for complex configurations of structures including groins.

253. Line D.1: INDG . Line D.1 asks if there are groins and short jetties on the calculation grid used in the particular simulation, setting the flag INDG . The great majority of groins as well as jetties at small channels do not extend beyond the average width of the surf zone; therefore, they should be treated as nondiffracting structures that interrupt the movement of sand alongshore. Bypassing of sand seaward around such structures is automatically calculated by GENESIS. If the value 1 ("yes") is placed at Line D.1, then responses are required at Lines D.3-D.5. If there are no short (nondiffracting) groins or jetties on the grid, a value of 0 ("no") should

be placed at Line D.1, and no other questions beginning with the letter D need to be answered. (If 0 is placed at Line D.1, Lines D.3-D.5 will not be read by GENESIS, and values remaining there may be arbitrary.)

254. Line D.3: NNDG . Enter the number of nondiffracting groins and jetties NNDG located on the grid. This number also includes structures that may serve as a groin boundary condition on one or both lateral ends of the grid.

255. Line D.4: IXNDG(I) . Enter the grid cell numbers of nondiffracting groins and jetties IXNDG(I) in order of increasing cell number. The number of grid cell locations given here should equal the number of nondiffracting groins specified at Line D.3 (NNDG values).

256. Line D.5: YNDG(I) . Enter the lengths of the nondiffracting groins and jetties YNDG(I) (as measured from the x-axis to the seaward tip of the structure) in the order of cell number in which they occur (NNDG values in increasing order of cell numbers corresponding to the locations given at Line D.4).

E. Diffracting groins and jetties

257. Line E.1: IDG . If there are long jetties and long groins on the grid (i.e., structures that extend past the breaking wave zone and into relatively deep water for almost all wave conditions), they should be treated as diffracting structures and the value 1 ("yes") placed here in the flag IDG . If there are no such structures on the grid, including the boundaries, then respond with the value 0 ("no"), and skip questions E.3-E.6. (If 0 is placed at Line E.1, Lines E.3-E.6 will not be read by GENESIS, and values remaining there may be arbitrary.)

258. Line E.3: NDG . Enter the number of diffracting groins and jetties NDG that are on the grid. This number includes structures that may serve as boundary conditions (at grid points 1 and N+1).

259. Line E.4: IXDG(I) . Enter the grid cell numbers of diffracting groins and jetties IXDG(I) in order of increasing cell number. There should be the same number of grid cell locations as the number of diffracting groins and jetties specified at Line E.3 (NDG values from small to large cell numbers).

260. Line E.5: YDG(I) . Enter the lengths of the diffracting groins and jetties YDG(I) as measured from the x-axis in the order of cell number in which they occur (NDG values from small to large cell numbers corresponding to the locations given at Line E.4).

261. Line E.6: DDG(I) . Enter the depths at the tips of the diffracting groins and jetties DDG(I) in the order of cell number in which they occur (NDG values from small to large cell numbers corresponding to the locations given at Line E.4).

F. Groins/jetties

262. Line F.1. This section requests general information pertaining to both nondiffracting and diffracting groins and jetties (and shore-connected breakwaters). If there are no groins or jetties on the grid (values of 0 entered at both Lines D.1 and E.1), then Lines F.2-F.5 may be skipped. If there are groins of any type, responses to Lines F.2-F.5 must be given. (If there are no groins or jetties on the grid, Lines F.2-F.5 will not be read by GENESIS, and values remaining there may be arbitrary.)

263. Line F.2: SLOPE2 . Groins impound sand on the side of predominant direction of drift, implying that the beach slope near a groin is milder than the equilibrium slope. An estimate of this slope SLOPE2 should be made by reference to measurements at the site or to other data. GENESIS uses this value in calculation of sand bypassing around the seaward tips of groins and jetties.

264. Line F.3: PERM(I) . Permeabilities PERM(I) (called "P" in the main text) of the groins and jetties must be assigned. Permeabilities should be given in order of increasing cell location of the structures as they appear on the grid, irrespective of whether the structure is nondiffracting or diffracting.

265. The permeability coefficient empirically accounts for transmission of sand through and over a groin. (Bypassing of sand around the seaward end of groins is automatically calculated by GENESIS.) A permeability value of 1.0 implies a completely transparent groin, whereas a value of 0.0 implies a high, impermeable groin that does not allow sand to pass through or over it. (Note: A completely transparent groin is not necessarily equivalent to a natural beach (no groin): a representative beach slope (Line F.2) must be

specified for the beach in the vicinity of groins, and this slope will usually be different (milder) than the equilibrium beach slope calculated with the representative grain size.)

266. Since a methodology does not presently exist to allow GENESIS or the modeler to calculate groin permeability by a standard or objective procedure, this quantity is best determined as part of model calibration. If a shoreline reach has numerous groins of various construction types and states of functioning, it is recommended that estimates of relative permeability be given initially and then refined in the course of the model calibration by observing the trend of shoreline change near the groins. As a rule of thumb, an apparently fully functioning groin with a crest above MSL for most tides is assigned an initial permeability value in the range of 0.0 to 0.1, whereas a groin that has gaps or is overtopped during parts of the tidal cycle may have a permeability in the range of 0.1 to 0.5. An effective method of estimating relative groin permeability is to compare the condition (number and width of gaps, thickness and height of groin) of groins on aerial photographs of the model reach.

267. Lines F.4 and F.5: YG1 , YGN . If a groin or jetty is located on a boundary (grid cell number 1 or N+1), the distance from the shoreline outside the grid to the seaward end of the structure YG1 and/or YGN must be specified (called "y_{G1}" and "y_{GN}" in the main text). Since this location is "off the grid," it must be given externally (by the modeler) and cannot be calculated. This distance is used in the sand bypassing calculation for the structure in situations where sand may be transported onto the grid.

G. Detached breakwaters

268. GENESIS treats a detached breakwater as a structure with two diffracting ends. The tips of detached breakwaters can be placed at different distances from the x-axis, and gap widths and breakwater lengths can also be arbitrary if a line of segmented detached breakwaters is to be represented. Generally speaking, detached breakwaters should be placed a distance offshore that is at least as far as the location of the average wave breaker line, to simulate the full diffracting effect of the detached breakwaters. If at any time step the waves break seaward of a detached breakwater, the wave height at

the diffracting tip will be set equal to the depth-limited wave height determined by the relation $H_b = \gamma D_b$.

269. GENESIS Version 2.0 does not allow formation of a tombolo; i.e., the model will fail if the shoreline reaches or comes close to the breakwater. It should also be noted that common diffraction theories, including the one used in GENESIS, are technically invalid if the structure is very short (a fraction of a wavelength) or for distances from the breakwater less than about one wavelength. Placement of detached breakwaters should be made carefully in light of these limitations.

270. A variety of configurations of detached breakwaters can be represented in GENESIS. Part VII gives examples of more intricate placements of detached breakwaters and the associated instructions in the START file.

271. Line G.1: IDB . If there are detached breakwaters on the model grid, the value 1 ("yes") of the flag IDB is entered here. If there are no such structures on the grid, including the boundaries, answer with the value 0 ("no"), and skip Lines G.3-G.9. (If the value 0 is placed at Line G.1, Lines G.3-G.9 will not be read by GENESIS, and values remaining there may be arbitrary.)

272. Line G.3: NDB . Enter the number of detached breakwaters NDB that appear on the grid.

273. Lines G.4 and G.5: IDB1 , IDBN . The flags IDB1 and IDBN tell GENESIS if there are detached breakwaters crossing the boundaries (no = 0; yes = 1). If a model boundary is placed across a detached breakwater, waves diffracted by the tip of the breakwater located outside the grid will not be taken into account. Thus, such a structure will be regarded as semi-infinite with only the tip of the breakwater lying within the grid to produce diffraction.

274. The capability of placing detached breakwaters across grid boundaries should be used with caution. If a groin is not simultaneously located on the boundary, GENESIS will apply the default pinned-beach boundary condition, which may not be appropriate in the shadow zone of the detached breakwater. The true meaning of the pinned-beach boundary condition is "the beach does not want to move"; if the pinned-beach boundary condition is improperly used, it may incorrectly mean "the beach is not allowed to move."

275. Line G.6: IXDB(I) . Enter the grid cell numbers of the tips of detached breakwaters IXDB(I) in ascending order of cell number. There should be two values for each detached breakwater located entirely within the calculation grid and one value for each additional detached breakwater extending across the calculation boundary.

276. Line G.7: YDB(I) . Enter the distances from the tips of the breakwaters to the x-axis YDB(I) in ascending order of cell number. There should be the same number of values as specified at Line G.6.

277. Line G.8: DDB(I) . Enter the depths DDB(I) at the tips of the breakwaters in ascending order of cell number. There should be the same number of values as specified at Line G.6.

278. Line G.9: TRANDB(I) . Enter the value of the wave transmission coefficient TRANDB(I) (called " K_T " in the main text) for the individual breakwaters (NDB values) in ascending order as the structures appear on the grid. This empirical coefficient accounts for wave transmission through a breakwater and by overtopping, and it must be evaluated either externally or as part of the calibration process, similar to the case of groin/jetty impermeability. The value of the wave transmission coefficient varies between 0.0 and 1.0 , where the value 0.0 describes a high, impermeable breakwater with no wave transmission through the structure by any means, and the value 1.0 describes a completely wave-transparent, ineffective structure.

H. Seawalls

279. A seawall constrains the allowable position of the shoreline because the beach cannot erode landward of the wall. Formally, GENESIS can describe only one seawall. However, noncontiguous sections of a seawall can be represented by placing the number -9999 in the SEAWL input file along the shore where seawalls are not present. Values of -9999 are assumed to place the seawall at locations so far landward that the wall would never come into play in the longshore transport and shoreline change calculations.

280. Line H.1: ISW . If there is one or more seawall sections along the modeled beach, the value 1 ("yes") is entered here for the flag ISW . If there are no seawalls, the value 0 ("no") is entered and Line H.3 can be skipped. (If the value 0 is entered at Line H.1, Line H.3 will not be read by GENESIS, and values remaining at Line H.3 may be arbitrary.) If there are

no seawalls present, GENESIS will not read from the input file SEAWL and will place the seawall at -9999 distance units as a default; values in the SEAWL file may be arbitrary in this case since the file will not be read.

281. Line H.3: ISWBEG , ISWEND . As stated in the preceding two paragraphs, if several seawall sections are present, they will be treated as a single seawall but with the sections between them located far landward of the shoreline. The grid cell numbers to be entered at this line correspond to the beginning ISWBEG and ending ISWEND of the single, continuous seawall. The two grid cell numbers are entered in ascending order. If ISWEND is set equal to -1 at line H.3, internally GENESIS will set ISWEND = N , which is a convenient default if all applications or variations for a project have a seawall running from ISWBEG to N .

I. Beach fills

282. If more than one beach fill occurs, information must be entered in order of occurrence of the fills. Fills may overlap in time and location, but information must be entered in the same order at each request. GENESIS treats the fill as having the same grain size and same berm height as the original beach.

283. GENESIS does not operate by direct use of fill volume but through the total distance of shoreline advance after the fill and beach profile have been molded to an equilibrium shape by wave action. (This distance must be specified by the modeler at Line I.8.) GENESIS places the fill by advancing the shoreline position in equal amounts at each time step between the starting and ending dates of the operation and within the cells defining the fill, as specified at the START file line numbers described in the following paragraphs. The fill is placed even if wave conditions are not sufficient to move sand alongshore and the shoreline change computation is not carried out (for example, during calm wave conditions).

284. Because GENESIS places fill by advancing the shoreline in equal daily amounts over the duration of the nourishment operation, a single fill advances uniformly over its longshore extent. A nonuniform advance over a given reach can be simulated by specifying several fills of different amounts on different sections of a total reach but placed within the same period.

285. Line I.1: IBF . If one or more beach fills is placed during the simulation period, a value of 1 ("yes") should be entered for the flag IBF and responses given at Lines I.3-I.8. If there are no beach fills, a value of 0 ("no") should be entered, and the remaining questions in this subsection may be disregarded. (If 0 is placed at Line I.1, Lines I.3-I.8 will not be read by GENESIS, and values remaining there may be arbitrary.)

286. Line I.3: NBF . The number of beach fills NBF that occurs during the simulation period is entered here.

287. Lines I.4 and I.5: BFDATS(I) , BFDATE(I) . The dates or time steps when placement of the fill(s) is begun BFDATS(I) and ended BFDATE(I) are respectively entered at these two lines, in chronological or increasing order from the beginning dates or time steps of the fills (NBF values, corresponding to line I.3). GENESIS keeps track of the date from the start of the simulation (Line A.6), and, if the fills are specified in terms of dates, GENESIS begins placing the fill on the beach at the date(s) specified.

288. Lines I.6 and I.7: IBFS(I) , IBFE(I) . The grid cell numbers of the starting IBFS(I) and ending IBFE(I) locations of the fills are entered at Lines I.6 and I.7, respectively, in the same order as entered at Lines I.4 and I.5 (NBF values). The cell number where a particular fill is started must be smaller than the cell number where it is ended. The fill is placed in all cells between and including the starting and ending cells.

289. Line I.8: YADD(I) . The amount of shoreline advance (advance of the berm) YADD(I) that will be added to the existing shoreline by GENESIS between the beginning and completion dates of the fill is given here. The distances of shoreline advance should be entered in the same order as in Lines I.4-I.7.

290. For a certain time period (on the order of weeks or months) after placement of a fill, waves and currents will remold the material to an equilibrium shape as determined by the grain size of the fill and the wave conditions. Fine particles, if present, will move offshore and out of the effective zone of longshore transport. Also, the berm of the initial fill may be higher than that of the original and neighboring beach. In the initial process of readjustment, therefore, the volume of the fill may decrease from that which was initially emplaced. It is presently beyond the scope of

GENESIS to compute the volume of the fill remaining after the transient readjustment period. The engineer operating GENESIS must judge conditions and make an external calculation to estimate the average distance the shoreline will advance after the fill has adjusted. (The fill volume per unit length of beach after equilibrium has been established can be calculated by multiplying the horizontal distance of berm advance, Line I.8, by the vertical distance from the berm crest, Line C.2, to the depth of closure, Line C.3, i.e., $YADD(ABH+DCLOS)$.)

 * INPUT FILE START.DAT FOR GENESIS VERSION 2.0 *

```

A----- MODEL SETUP -----A
A.1 RUN TITLE
    ILLUSTRATIVE EXAMPLE FOR MANUAL
A.2 INPUT UNITS (METERS=1; FEET=2): ICONV
    2
A.3 TOTAL NUMBER OF CALCULATION CELLS AND CELL LENGTH: NN, DX
    37 200
A.4 GRID CELL NUMBER WHERE SIMULATION STARTS AND NUMBER OF CALCULATION
    CELLS (N = -1 MEANS N = NN): ISSTART, N
    1 -1
A.5 VALUE OF TIME STEP IN HOURS: DT
    12
A.6 DATE WHEN SHORELINE SIMULATION STARTS
    (DATE FORMAT YYMMDD: 1 MAY 1992 = 920501): SIMDATS
    870101
A.7 DATE WHEN SHORELINE SIMULATION ENDS OR TOTAL NUMBER OF TIME STEPS
    (DATE FORMAT YYMMDD: 1 MAY 1992 = 920501): SIMDATE
    870131
A.8 NUMBER OF INTERMEDIATE PRINT-OUTS WANTED: NOUT
    1
A.9 DATES OR TIME STEPS OF INTERMEDIATE PRINT-OUTS
    (DATE FORMAT YYMMDD: 1 MAY 1992 = 920501, NOUT VALUES): TOUT(I)
    870115
A.10 NUMBER OF CALCULATION CELLS IN OFFSHORE CONTOUR SMOOTHING WINDOW
    (ISMOOTH = 0 MEANS NO SMOOTHING, ISMOOTH = N MEANS STRAIGHT LINE.
    RECOMMENDED VALUE = 11): ISMOOTH
    11
A.11 REPEATED WARNING MESSAGES (YES=1; NO=0): IRWM
    1
A.12 LONGSHORE SAND TRANSPORT CALIBRATION COEFFICIENTS: K1, K2
    .77 .38
A.13 PRINT-OUT OF THE TIME STEP NUMBERS? (YES=1, NO=0): IPRINT
    1
B----- WAVES -----B
B.1 WAVE HEIGHT CHANGE FACTOR. WAVE ANGLE CHANGE FACTOR AND AMOUNT (DEG)
    (NO CHANGE: HCNGF=1, ZCNGF=1, ZCNGA=0): HCNGF, ZCNGF, ZCNGA
    1 1 0
B.2 DEPTH OF OFFSHORE WAVE INPUT: DZ
    60
B.3 IS AN EXTERNAL WAVE MODEL BEING USED (YES=1; NO=0): NWD
    0
B.4 COMMENT: IF AN EXTERNAL WAVE MODEL IS NOT BEING USED, CONTINUE TO B.6
B.5 NUMBER OF SHORELINE CALCULATION CELLS PER WAVE MODEL ELEMENT: ISPW
    1
B.6 VALUE OF TIME STEP IN WAVE DATA FILE IN HOURS (MUST BE AN EVEN MULTIPLE
    OF, OR EQUAL TO DT): DTW
    12
  
```

Figure 23. Example START file (Sheet 1 of 3)

B.7 NUMBER OF WAVE COMPONENTS PER TIME STEP: NWAVES
1

B.8 DATE WHEN WAVE FILE STARTS (FORMAT YYMMDD: 1 MAY 1992 = 920501): WDATS
870101

C----- BEACH -----C

C.1 EFFECTIVE GRAIN SIZE DIAMETER IN MILLIMETERS: D50
0.25

C.2 AVERAGE BERM HEIGHT FROM MEAN WATER LEVEL: ABH
3

C.3 CLOSURE DEPTH: DCLOS
15

D----- NONDIFFRACTING GROINS -----D

D.1 ANY NONDIFFRACTING GROINS? (NO=0, YES=1): INDG
1

D.2 COMMENT: IF NO NONDIFFRACTING GROINS, CONTINUE TO E.

D.3 NUMBER OF NONDIFFRACTING GROINS: NNDG
1

D.4 GRID CELL NUMBERS OF NONDIFFRACTING GROINS (NNDG VALUES): IXNDG(I)
15

D.5 LENGTHS OF NONDIFFRACTING GROINS FROM X-AXIS (NNDG VALUES): YNDG(I)
200

E----- DIFFRACTING (LONG) GROINS AND JETTIES -----E

E.1 ANY DIFFRACTING GROINS OR JETTIES? (NO=0, YES=1): IDG
1

E.2 COMMENT: IF NO DIFFRACTING GROINS, CONTINUE TO F.

E.3 NUMBER OF DIFFRACTING GROINS/JETTIES: NDG
1

E.4 GRID CELL NUMBERS OF DIFFRACTING GROINS/JETTIES (NDG VALUES): IXDG(I)
5

E.5 LENGTHS OF DIFFRACTING GROINS/JETTIES FROM X-AXIS (NDG VALUES): YDG(I)
230

E.6 DEPTHS AT SEAWARD END OF DIFFRACTING GROINS/JETTIES(NDG VALUES): DDG(I)
5

F----- ALL GROINS/JETTIES -----F

F.1 COMMENT: IF NO GROINS OR JETTIES, CONTINUE TO G.

F.2 REPRESENTATIVE BOTTOM SLOPE NEAR GROINS: SLOPE2
0.062

F.3 PERMEABILITIES OF ALL GROINS AND JETTIES (NNDG+NDG VALUES): PERM(I)
0.0 .1

F.4 IF GROIN OR JETTY ON LEFT-HAND BOUNDARY, DISTANCE FROM SHORELINE
OUTSIDE GRID TO SEAWARD END OF GROIN OR JETTY: YG1

F.5 IF GROIN OR JETTY ON RIGHT-HAND BOUNDARY, DISTANCE FROM SHORELINE
OUTSIDE GRID TO SEAWARD END OF GROIN OR JETTY: YGN

G----- DETACHED BREAKWATERS -----G

G.1 ANY DETACHED BREAKWATERS? (NO=0, YES=1): IDB
1

G.2 COMMENT: IF NO DETACHED BREAKWATERS, CONTINUE TO H.

Figure 23. (Sheet 2 of 3)

G.3 NUMBER OF DETACHED BREAKWATERS: NDB
1

G.4 ANY DETACHED BREAKWATER ACROSS LEFT-HAND CALCULATION BOUNDARY
(NO=0, YES=1): IDB1
0

G.5 ANY DETACHED BREAKWATER ACROSS RIGHT-HAND CALCULATION BOUNDARY
(NO=0, YES=1): IDBN
0

G.6 GRID CELL NUMBERS OF TIPS OF DETACHED BREAKWATERS:
(2 * NDB - (IDB1+IDBN) VALUES): IXDB(I)
20 30

G.7 DISTANCES FROM X-AXIS TO TIPS OF DETACHED BREAKWATERS
(1 VALUE FOR EACH TIP SPECIFIED IN G.6): YDB(I)
450 450

G.8 DEPTHS AT DETACHED BREAKWATER TIPS (1 VALUE FOR EACH TIP
SPECIFIED IN G.6): DDB(I)
15 15

G.9 DETACHED BREAKWATER TRANSMISSION COEFFICIENTS (NDB VALUES): TRANDB(I)
0

H----- SEAWALLS -----H

H.1 ANY SEAWALL ALONG THE SIMULATED SHORELINE? (YES=1; NO=0): ISW
1

H.2 COMMENT: IF NO SEAWALL, CONTINUE TO I.

H.3 GRID CELL NUMBERS OF START AND END OF SEAWALL (ISWEND = -1 MEANS
ISWEND = N): ISWBEG, ISWEND
5 16

I----- BEACH FILLS -----I

I.1 ANY BEACH FILLS DURING SIMULATION PERIOD? (NO=0, YES=1): IBF
1

I.2 COMMENT: IF NO BEACH FILLS, CONTINUE TO K.

I.3 NUMBER OF BEACH FILLS DURING SIMULATION PERIOD: NBF
1

I.4 DATES OR TIME STEPS WHEN THE RESPECTIVE FILLS START
(DATE FORMAT YMMDD: 1 MAY 1992 = 920501, NBF VALUES): BFDATS(I)
870101

I.5 DATES OR TIME STEPS WHEN THE RESPECTIVE FILLS END
(DATE FORMAT YMMDD: 1 MAY 1992 = 920501, NBF VALUES): BFDATE(I)
870115

I.6 GRID CELL NUMBERS OF START OF RESPECTIVE FILLS (NBF VALUES): IBFS(I)
20

I.7 GRID CELL NUMBERS OF END OF RESPECTIVE FILLS (NBF VALUES): IBFE(I)
33

I.8 ADDED BERM WIDTHS AFTER ADJUSTMENT TO EQUILIBRIUM CONDITIONS
(NBF VALUES): YADD(I)
30

K----- COMMENTS -----K

* COMMENTS AND VERSION UPDATE INFORMATION PLACED HERE

* ADVERTISING RATES AVAILABLE

----- END OF START.DAT -----

Figure 23. (Sheet 3 of 3)

SHORL

291. The input file SHORL.DAT holds the position of the initial shoreline, i.e., the shoreline used by GENESIS at the start of calculation. In a typical project, there will be at least three SHORL files, one each for the calibration, the verification, and the project to be designed (present-day shoreline position). Positions of the shoreline are given in the units selected at Line A.2 of the START file and are measured from the baseline (x-axis). A shoreline position must be given for each grid cell; i.e., there must be NN calculation cells as entered at Line A.3 in the START file. An example of a SHORL file is given in Figure 24.

292. If the modeler specifies at Line A.4 in the START file that only a portion of the shoreline will be used in the simulation, then only that segment of the shoreline between and including the boundary cells is loaded from SHORL. However, shoreline positions must be given for the full range of the calculation grid (NN points), as GENESIS will load positions of the shoreline subsection with reference to the original, full grid.

293. Shoreline positions may be entered in "free format," i.e., with or without a decimal. Individual entries must be separated by either a blank space or a comma (or both) and placed in ascending order of grid cell number. Exactly ten entries must be placed on each line, except for the last line.

```
*****
SHORELINE MEASURED AT SUNNY DAYS BEACH 1 JAN 1987.
DATA WERE TAKEN FROM DIGITIZED AERIAL PHOTO.  DX = 300 FT.
*****
100.0 100.1 100.2 100.3 100.4 100.6 100.7 100.9 101.1 101.3.
101.6 102.0 102.3 102.8 103.3 103.9 104.5 105.3 106.2 107.2
108.3 109.5 110.9 112.5 114.2 116.1 118.3 120.6 123.1 125.9
128.9 132.1 135.6 139.4 143.4 147.8 149.9
```

Figure 24. Example SHORL file

SHORM

294. The input file SHORM.DAT holds the position of the measured shoreline to be reproduced in the procedure of calibrating or verifying the model. The format for SHORM is the same as for SHORL.DAT. Thus, positions of the shoreline are given in the units selected at Line A.2 of the START file and are measured from the baseline (x-axis). A shoreline position must be given for each grid cell; i.e., there must be NN calculation cells as entered at Line A.3 in the START file. An example of a SHORM file is given in Figure 25.

295. GENESIS calculates a number called the "calibration/verification error" (CVE) as the average of the absolute difference between the calculated shoreline position (held in SHORC) and the measured shoreline position (held in SHORM) at each grid point. This number conveniently summarizes in a single value the degree of agreement between the calculated and measured shorelines. The CVE should not be used as the sole criterion to judge the degree of fit since a small value does not necessarily mean that the calculated and measured shorelines are in close agreement along the entire calculated shoreline. As an example, two shorelines may be in close agreement along most portions of the beach but may be far apart along a small but very important section of the beach. A small CVE value would not reveal this important discrepancy. Determination of the degree of fit is best done visually, which allows examination of the overall fit.

296. If the modeler specified at Line A.4 in the START file that only a portion of the shoreline will be used in the simulation, then only that segment of the shoreline between and including the boundary cells is loaded from SHORM. However, shoreline positions must be given for the full range of the calculation grid (NN points), as GENESIS will load positions of the shoreline subsection with reference to the original, full grid.

297. Shoreline positions may be entered in "free format," i.e., with or without a decimal. Individual entries must be separated by either a blank space or a comma (or both) and placed in ascending order of grid cell number. Exactly ten entries must be placed on each line, except for the last line.

```

*****
SHORELINE MEASURED AT SUNNY DAYS BEACH 1 JAN 1988.
DATA WERE TAKEN FROM DIGITIZED AERIAL PHOTO.  DX = 300 FT.
*****
100.0 100.1 100.2 100.4 100.5 101.0 101.7 102.0 102.8 103.5
103.9 102.9 103.0 103.5 103.8 104.6 104.3 106.3 107.0 107.4
108.0 100.1 101.2 103.4 105.9 109.0 100.1 103.6 106.8 109.2
131.1 133.6 134.9 136.1 138.5 140.0 141.1

```

Figure 25. Example SHORM file

SEAWL

298. The input file SEAWL.DAT holds the positions of one or more seawalls or effective seawalls with respect to the baseline and specified in the proper length units. An "effective" seawall might be a road or large structure past which the shoreline is not expected to erode or be allowed to erode. GENESIS prevents the shoreline from eroding landward of the position of a seawall, whereas at reaches without seawalls the shoreline can retreat essentially without limit. If a seawall is not specified, an effective seawall is placed at -9999 m or ft (depending on units selected) by GENESIS, and SEAWL is not read. If seawalls are specified along some sections of coast but not others, the sections without seawalls should be similarly assigned a distance of -9999 m or ft by the modeler. Figure 26 gives an example of a SEAWL file.

299. Similar to the case of preparing a SHORL file, if a seawall was specified to exist on the grid, the location of the seawall(s) (or -9999 for each cell between seawalls) must be entered on the full calculation grid (NN values), even if only a subsection of the grid will be modeled. Seawall positions are entered at shoreline position points, i.e., at the centers of grid cells.

300. Seawall positions alongshore may be entered in "free format," i.e., with or without a decimal. Individual entries must be separated by either a blank space or a comma (or both) and placed in ascending order of cell number. Exactly ten entries must be placed on each line, except for the last line.

```

*****
SEAWALL LOCATION MEASURED AT SUNNY DAYS BEACH.
DATA WERE TAKEN FROM DIGITIZED AERIAL PHOTO. DX = 300 FT.
*****
-9999 -9999 -9999 -9999 100.0 100.0 100.0 100.0 100.0 100.0
100.0 100.0 100.0 100.0 100.0 100.0 -9999 -9999 -9999 -9999
-9999 -9999 -9999 -9999 -9999 -9999 -9999 -9999 -9999 -9999
-9999 -9999 -9999 -9999 -9999 -9999 -9999

```

Figure 26. Example SEAWL file

DEPTH

301. The input file DEPTH.DAT is read if an external wave refraction model has previously been run (NWD = 1 at Line B.3 in the START file) to provide wave data. DEPTH holds depths along the nearshore reference line from which GENESIS will continue to propagate waves using its own wave transformation routines (internal wave model). These depths had to be determined during the process of running the external wave model, and the wave data held in input file WAVES will bear a one-to-one correspondence with these depths in order of grid cell number. If an external wave refraction model was not used, i.e., wave parameters correspond to one depth (NWD = 0), this file will not be read. A blank DEPTH file is given in Appendix B.

302. Depth positions alongshore may be entered in "free format," i.e., with or without a decimal. Individual entries must be separated by either a blank space or a comma (or both) and placed in ascending order of grid cell number. Ten entries must be placed on each line, except for the last line.

WAVES

303. The input file WAVES.DAT holds wave information that drives the shoreline change simulation through calculation of the wave-induced longshore sand transport rate. This file is read at every time step unless specified otherwise at Line B.7 in the START file; it must exist and contain data in the proper format to run GENESIS. Wave height is expressed in the user-specified

units as significant wave height. Wave angles are expressed in degrees, and wave period is expressed in seconds.

304. The number of data lines contained in WAVES does not have to correspond to the total number of calculation time steps. However, the WAVES input file must be designed to provide the data at the specified time step. WAVES is automatically rewound if the end of the file is reached, and wave data are again read from the start of the file. A simple way to represent a constant wave climate through time (for testing and scoping purposes, for example) is to place only one line of data in WAVES. In this case, the variable DTW at Line B.6 in the START file is recommended to be set equal to or greater than the number of time steps to be used, as determined by the values entered at Lines A.6 and A.7. Otherwise, the WAVES file will be rewound numerous times, increasing required computer time.

305. NWD = 1. If an external wave transformation model was used (NWD = 1 in Line B.3 of the START file), at each time step WAVES must contain:

- a. The wave period (assumed to be constant over the calculation reach during the time step).
- b. The wave height and wave direction at one offshore location (at the depth DZ specified at Line B.2 of the START file).
- c. The wave height and the wave direction for each point on the nearshore depth reference line.

306. The three offshore quantities of wave period, height, and direction are placed on the same line and may be entered in "free format," i.e., with or without a decimal. Individual entries must be separated by either a blank space or a comma (or both). If the period is negative, GENESIS will not calculate for the particular time step. This capability is a convenient means to represent a calm wave condition for which there will be no longshore sand transport.

307. The total set of values of wave height and direction at each grid point alongshore on the nearshore grid for each time step of the simulation comprise a considerable amount of data. Therefore, these data are held in "compressed format" in the WAVES file to minimize storage space. Thus, values of individual pairs of wave height H and wave direction Z (called " θ " in the main text) at nearshore grid points are held in a quantity IZH and read in the integer format 10I7, in which IZH is calculated as

$$IZH = H \cdot 10^5 + Z \cdot 10 \quad (42)$$

If the length unit is meters, H must be given to the nearest centimeter (in the format F4.2), whereas if the length unit is feet, H must be given to the nearest tenth of a foot (format F4.1).

308. The integer IZH will be converted to real numbers by GENESIS. If the wave direction is negative, IZH should be given a negative sign.

Example 1: If ICONV = 1 (metric units selected at Line A.2 in the START file), H = 2.18 m and Z = 10.7 deg will produce the value IZH = 218107 .

Example 2: If ICONV = 1 , H = 1.14 m and Z = -6.5 deg will produce the value IZH = -114065 .

Example 3: If ICONV = 2 (American customary units selected), H = 10.1 ft and Z = 21.0 deg will produce the value IZH = 101210 .

309. It can be seen that the largest nearshore wave height that can be entered depends on the units selected and is either 9.99 m or 99.9 ft, and the largest magnitude of the wave angle is 99.9 deg. (If the wave refraction and shoreline grids are parallel to each other, a wave approaching normal to the shoreline will have an angle of 0 deg; therefore, the practical maximum magnitude of the wave angle is 89.9 deg. Usually, wave angles will have much smaller magnitudes.)

310. In summary, wave heights can be expressed to the nearest centimeter if metric units are used or to the nearest tenth of a foot if American customary units are used. Wave direction can be specified to the nearest tenth of a degree. The construction of WAVES files with data from an external wave calculation is given in the GENESIS Workbook.

311. NWD = 0 . If NWD = 0 was entered in the START file, simple wave refraction and shoaling algorithms contained in GENESIS will be used to bring waves from the offshore depth specified at Line B.2 to breaking points alongshore. This procedure will treat the local bottom contour as being straight and parallel to the calculated offshore contour (see Part V). In this case, for each time step, WAVES contains only the offshore wave period, height, and direction in the format described above for the case of NWD = 1 . Examples of WAVES files with and without nearshore waves with only one wave component

(NWAVES - 1) are given in Figure 27. In Figure 27a each line corresponds to one time step, whereas in Figure 27b one line with 3 values together with the following four lines with 10 values each represent one time step. As shown, it is possible to add descriptive information at the end of any line holding the offshore wave period, height, and direction.

Output Files

312. As illustrated in Figure 22, the output from GENESIS is placed in three files; SETUP.DAT, OUTPT.DAT, and SHORC.DAT.

SETUP

313. The output file SETUP.DAT is written both to screen and to a logical file that can be sent to a printer for a hard copy. SETUP reads back to the modeler basic information and instructions entered in the START file. Also, error messages and warnings received from GENESIS are written to SETUP. The SETUP information displayed on screen allows the modeler to review the parameters governing the run and to terminate execution if an error is detected in the START file. This measure helps to quickly identify computer runs made on the basis of erroneous input information. The hard copy of SETUP serves as documentation of the run and confirmation of the START file that defined the run conditions.

314. As shown in Figure 28, the first line in the SETUP file after the GENESIS logo gives the name of the run as specified on Line A.1 in the START file. Units of measure and other important parameter values follow. With regard to NTS, it should be noted that if the simulation interval spans a leap year or years, the value of NTS will not initially account for the extra day(s); however, as GENESIS steps through time if February 29th is encountered, the counter NTS will be revised appropriately on the screen (and for the calculation). The shoreline position and the change in shoreline position from the original shoreline are written separately. The CVE parameter gives the average difference in position at each longshore grid cell between the calculated shoreline SHORC and the shoreline SHORM that is to be reproduced.

WAVES FOR ILLUSTRATIVE EXAMPLE FOR MANUAL.

FILE CONTAINS ONLY OFFSHORE WAVE DATA. DT = 6 HR. DX = 15 FT.

```

2.0 1.00 -30.0 JAN 1987
2.0 1.00 00.0
2.0 1.00 00.0
3.0 1.00 -30.0
2.0 1.00 00.0
2.0 1.00 00.0
3.0 2.00 15.0
2.0 1.00 00.0
2.0 1.00 00.0
3.0 2.00 15.0
2.0 1.00 00.0
2.0 1.00 00.0
3.0 1.00 15.0
2.0 1.00 00.0
2.0 1.00 00.0
3.0 2.00 38.0
2.0 1.00 00.0
2.0 .....

```

a. WAVES file without nearshore wave data

WAVES FOR ILLUSTRATIVE EXAMPLE FOR MANUAL.

FILE CONTAINS OFFSHORE & NEARSHORE WAVE DATA. DT = 6 HR. DX = 15 FT.

```

2.0 1.00 -30.0 JAN 1987
-114185-116203-118172-121160-123158-120155-172153-124121-102134-097119
-103122-113183-110201-127162-129167-125164-124146-154163-129199-112133
-124146-154163-129199-112133-116203-118172-121160-123158-120155-172153
-124121-102134-097119-125164-124146-154163-129199-112133-154163-129199
-112133-116203-118172-121160-123158-120155-172153
2.0 1.00 00.0
-114185-116203-118172-121160-123158-120155-172153-124121-102134-097119
-103122-113183-110201-127162-129167-125164-124146-154163-129199-112133
-124146-154163-129199-112133-116203-118172-121160-123158-120155-172153
-124121-102134-097119-125164-124146-154163-129199-112133-154163-129199
-112133-116203-118172-121160-123158-120155-172153
2.0 1.00 00.0
-114185-116203-118172-121160.....

```

b. WAVES file with nearshore wave data

Figure 27. Example WAVES files

COASTAL ENGINEERING RESEARCH CENTER
&
LUND INSTITUTE OF TECHNOLOGY

```

*****  *****  **  **  *****  *****  *****  *****
*****  *****  **  **  *****  *****  *****  *****
**  **  **      ***  **  **      **  **  **      **  **  **
**  **  **      ***  **  **      **  **  **      **  **  **
**      **      ****  **  **      **      **      **      **
**      *****  ****  **  *****  *****  **      *****
**  ***  *****  **  ****  *****  *****  **      *****
**  ***  **      **  ****  **      **      **      **      **
**  **  **      **  ***  **      **  **  **      **  **  **
**  **  **      **  ***  **      **  **  **      **  **  **
*****  *****  **  **  *****  *****  *****  *****
*****  *****  **  **  *****  *****  *****  *****

```

```

+-----+
|  VERSION  2.0  |
+-----+

```

RUN: ILLUSTRATIVE EXAMPLE FOR MANUAL

AMERICAN CUSTOMARY UNITS

GROIN X-COORDINATES

5 15

DISTANCE TO GROIN TIPS FROM X-AXIS

230.0 200.0

GROIN PERMEABILITIES

0.0 0.1

X-COORDINATES OF DETACHED BREAKWATER TIPS

20 30

DISTANCE TO BREAKWATER TIPS FROM X-AXIS

450.0 450.0

DETACHED BREAKWATER TRANSMISSION COEFFICIENTS

0.0

DATES OR TIME STEPS WHEN FILLS START

870101

DATES OR TIME STEPS WHEN FILLS END

870115

X-COORDINATES WHERE FILLS START

20

Figure 28. Example SETUP file (Continued)

X-COORDINATES WHERE FILLS END

33

DX = 200.0 DT = 12.00 ISSTART = 1 N = 37 NTS = 60
NWAVES = 1 DCLOS = 15.0 ABH = 3.0 DZ = 60.0 D50 = 0.25
HCNGF = 1.0 ZCNGF = 1.0 ZCNGA = 0.0 K1 = 0.77 K2 = 0.38

SHORELINE POSITION AFTER 0.YEARS = 60 TIME STEPS. DATE IS 870131
100.0 101.9 107.0 120.6 100.0 100.0 100.0 100.0 100.0 100.0
100.0 100.0 100.2 111.3 100.0 100.0 90.1 104.5 116.9 137.4
148.2 145.2 144.6 145.5 147.0 148.9 151.6 155.8 154.5 146.7
151.7 156.2 155.2 149.1 146.4 147.4 149.9

SHORELINE CHANGE AFTER 0.YEARS = 60 TIME STEPS. DATE IS 870131
0.0 1.8 6.8 20.3 -0.4 -0.6 -0.7 -0.9 -1.1 -1.3
-1.6 -2.0 -2.1 8.5 -3.3 -3.9 -14.4 -0.8 10.7 30.2
39.9 35.7 33.7 33.0 32.8 32.8 33.3 35.2 31.4 20.8
22.8 24.1 19.6 9.7 3.0 -0.4 0.0

OUTPUT LAST TIMESTEP NO. 60 DATE IS 870131

OFFSHORE WAVE DATA INPUT:

HZ = 1.00000 T = 2.00000 ZZ = 0.000000

CALIBRATION/VERIFICATION ERROR = 17.9221

CALCULATED VOLUMETRIC CHANGE = +5.03E+04 (YARDS³)
SIGN CONVENTION: "-" => EROSION, "+" => ACCRETION

Figure 28. (Concluded)

OUTPT

315. The file OUTPT.DAT holds the major output and calculation results of the run. This information is printed to file automatically at the end of the simulation period and at time step numbers specified in the START file (Line A.9) by the user. OUTPT contains:

- a. Run title and initial shoreline position from the x-axis.
- b. Calculated shoreline position from the x-axis at the given time steps.
- c. Volume of sand transported alongshore at each grid cell, expressed as a volume per unit time interval, i.e., per annum.
- d. Breaking wave height and direction at each point alongshore calculated for each energy window.

- e. Longshore sand transport rate at each point alongshore for the last time step.
- f. Calculated shoreline at the end of the calculation and seawardmost and landwardmost shoreline positions during the calculation period.
- g. Calculated position of the representative contour. GENESIS uses only the orientation of the line and not the absolute position. For convenience, the line is placed 300 m (or the corresponding distance in feet) seaward of the shoreline.

RUN: ILLUSTRATIVE EXAMPLE FOR MANUAL

INITIAL SHORELINE POSITION (FT)

100.0	100.1	100.2	100.3	100.4	100.6	100.7	100.9	101.1	101.3
101.6	102.0	102.3	102.8	103.3	103.9	104.5	105.3	106.2	107.2
108.3	109.5	110.9	112.5	114.2	116.1	118.3	120.6	123.1	125.9
128.9	132.1	135.6	139.4	143.4	147.8	149.9			

SHORELINE POSITION (FT) AFTER 29 TIME STEPS.

DATE IS 870115

100.0	100.3	102.1	110.1	100.0	100.0	100.0	100.0	100.0	100.0
100.0	100.0	101.5	111.2	100.0	100.0	101.0	105.1	111.1	137.9
143.1	142.2	142.7	144.0	145.6	147.5	150.0	153.3	154.3	151.7
156.0	160.6	160.6	144.6	144.1	147.0	149.9			

LAST TIME STEP. WAVES ORIGINATING FROM WINDOW

NO.

1

BREAKING WAVE HEIGHT

0.97	0.97	0.97	0.97	0.97	0.00	0.00	0.00	0.00	0.00
0.00	0.00	0.00	0.00	0.00	0.00	0.00	0.00	0.00	0.00
0.00	0.00	0.00	0.00	0.00	0.00	0.00	0.00	0.00	0.00
0.00	0.00	0.00	0.00	0.00	0.00	0.00	0.00	0.00	0.00

BREAKING WAVE ANGLE TO X-AXIS

0.05	0.05	0.10	0.25	0.02	0.00	0.00	0.00	0.00	0.00
0.00	0.00	0.00	0.00	0.00	0.00	0.00	0.00	0.00	0.00
0.00	0.00	0.00	0.00	0.00	0.00	0.00	0.00	0.00	0.00
0.00	0.00	0.00	0.00	0.00	0.00	0.00	0.00	0.00	0.00

LAST TIME STEP. WAVES ORIGINATING FROM WINDOW

NO.

2

BREAKING WAVE HEIGHT

0.00	0.00	0.00	0.00	0.96	0.94	0.95	0.95	0.95	0.95
0.95	0.95	0.95	0.95	0.95	0.94	0.94	0.92	0.87	0.68
0.41	0.28	0.23	0.20	0.18	0.17	0.17	0.16	0.16	0.15
0.15	0.15	0.15	0.14	0.14	0.14	0.14			

BREAKING WAVE ANGLE TO X-AXIS

0.00	0.00	0.00	0.00	0.02	0.02	0.02	0.02	0.03	0.03
0.04	0.04	0.05	0.28	0.07	0.07	-0.14	0.43	0.47	1.25
14.50	14.44	15.10	15.22	15.10	14.99	15.00	15.25	13.66	11.70
15.21	15.00	13.37	11.85	12.81	13.82	14.19			

Figure 29. Example OUTPT file (Sheet 1 of 3)

LAST TIME STEP. WAVES ORIGINATING FROM WINDOW NO. 3

BREAKING WAVE HEIGHT

0.00	0.00	0.00	0.00	0.14	0.14	0.14	0.14	0.14	0.14
0.14	0.14	0.14	0.15	0.15	0.15	0.15	0.15	0.15	0.16
0.16	0.16	0.17	0.17	0.18	0.20	0.23	0.28	0.41	0.69
0.88	0.93	0.95	0.95	0.95	0.96	0.96			

BREAKING WAVE ANGLE TO X-AXIS

0.00	0.00	0.00	0.00	0.02	-13.39	-13.42	-13.44	-13.47	-13.50
-13.53	-13.57	-13.59	-10.46	-13.53	-13.76	-16.59	-9.85	-10.53	-8.27
-11.12	-14.99	-14.49	-14.28	-14.36	-14.51	-14.60	-14.23	-12.98	-1.14
0.43	0.40	0.31	0.21	0.28	0.35	0.38			

GROSS TRANSPORT VOLUME (YARDS3) FOR CALCULATED PART OF YEAR 87

4925	4925	4871	4679	0	4607	4845	4897	4912	4918
4924	4917	4873	4662	458	4826	5155	4630	4252	2713
2240	1208	746	556	469	435	446	545	913	795
2610	3847	4547	5992	4928	4691	4723	4723		

NET TRANSPORT VOLUME (YARDS3) FOR CALCULATED PART OF YEAR 87

3867	3867	3619	2704	0	52	132	225	346	492
666	880	1146	1420	299	739	1260	3171	3276	1847
2115	1074	598	390	274	190	102	-49	-454	-344
1171	2421	3494	5168	3875	3477	3530	3530		

TRANSPORT VOLUME TO THE LEFT (YARDS3) FOR CALCULATED PART OF YEAR 87

-529	-529	-625	-987	0	-521	-525	-525	-527	-526
-524	-527	-552	-1025	-94	-511	-482	-729	-488	-433
-62	-66	-73	-83	-97	-122	-171	-297	-683	-569
-719	-712	-526	-412	-526	-606	-596	-596		

TRANSPORT VOLUME TO THE RIGHT (YARDS3) FOR CALCULATED PART OF YEAR 87

4396	4396	4245	3691	0	4086	4319	4372	4384	4392
4400	4389	4320	3636	363	4315	4673	3900	3764	2280
2177	1141	672	473	371	312	274	248	229	225
1890	3134	4021	5580	4402	4084	4126	4126		

OUTPUT OF BREAKING WAVE STATISTICS FOR SELECTED LOCATIONS
 N.B. WAVE DIFFRACTION IS NOT ACCOUNTED FOR!
 GRID CELL NUMBERS

1	2	3	4	5	6	7	8	9	10
11	12	13	14	15	16	17	18	19	20
21	22	23	24	25	26	27	28	29	30
31	32	33	34	35	36	37			

AVERAGE UNDIFFRACTED BREAKING WAVE HEIGHTS (FT).

1.2	1.2	1.2	1.2	1.2	1.2	1.2	1.2	1.2	1.2
1.2	1.2	1.2	1.2	1.2	1.2	1.2	1.2	1.2	1.2
1.2	1.2	1.2	1.2	1.2	1.2	1.2	1.2	1.2	1.2
1.2	1.2	1.2	1.2	1.2	1.2	1.2			

Figure 29. (Sheet 2 of 3)

AVERAGE UNDIFFRACTED BREAKING WAVE ANGLE TO SHORELINE (DEG)

1.1	1.1	0.7	-0.9	1.3	1.4	1.3	1.3	1.3	1.3
1.3	1.3	1.2	-0.9	1.2	1.3	1.9	-0.3	-0.4	-4.2
-0.1	1.7	1.3	1.1	1.1	1.0	0.9	0.6	1.3	2.4
0.4	0.4	1.5	4.4	1.7	0.9	0.9			

AVERAGE LONGSHORE TRANSPORT RATE BASED ON UNDIFFRACTED WAVES (FT3/SEC)

0.04	0.04	0.04	0.03	0.04	0.04	0.04	0.04	0.04	0.04
0.04	0.04	0.04	0.03	0.04	0.04	0.04	0.03	0.03	0.00
0.03	0.04	0.04	0.04	0.04	0.04	0.04	0.04	0.04	0.05
0.04	0.04	0.04	0.06	0.04	0.04	0.04			

LONGSHORE TRANSPORT (FT3/SEC)

0.00	0.00	0.00	-0.01	0.00	0.00	0.00	0.00	0.00	0.00
0.00	0.00	0.00	-0.01	0.00	0.00	0.00	-0.01	-0.01	-0.01
0.00	0.00	0.00	0.00	0.00	0.00	0.00	0.00	-0.01	0.00
0.00	0.00	0.00	0.01	0.00	0.00	0.00	0.00		

CALCULATED FINAL SHORELINE POSITION (FT)

100.0	101.9	107.0	120.6	100.0	100.0	100.0	100.0	100.0	100.0
100.0	100.0	100.2	111.3	100.0	100.0	90.1	104.5	116.9	137.4
148.2	145.2	144.6	145.5	147.0	148.9	151.6	155.8	154.5	146.7
151.7	156.2	155.2	149.1	146.4	147.4	149.9			

CALCULATED SEAWARDMOST SHORELINE POSITION (FT)

100.0	101.9	107.0	120.8	101.6	100.6	100.7	100.9	101.1	101.3
101.6	102.0	102.8	112.2	104.3	103.9	104.5	105.4	116.9	138.8
148.2	145.2	144.6	145.5	147.0	148.9	151.6	155.8	155.4	152.8
157.1	161.6	161.5	149.1	146.4	147.8	149.9			

CALCULATED LANDWARDMOST SHORELINE POSITION (FT)

100.0	100.1	100.1	99.2	100.0	100.0	100.0	100.0	100.0	100.0
100.0	100.0	100.1	101.7	100.0	100.0	90.0	104.5	105.7	107.2
108.3	109.5	110.9	112.5	114.2	116.1	118.3	120.6	123.1	125.9
128.9	132.1	135.6	139.4	143.4	147.0	149.9			

CALCULATED REPRESENTATIVE OFFSHORE CONTOUR POSITION (FT)

1084.3	1084.4	1084.6	1084.7	1084.9	1085.0	1085.2	1085.5	1085.7	1086.0
1086.4	1086.8	1087.2	1087.7	1088.3	1089.0	1089.8	1090.6	1091.6	1092.7
1093.9	1095.3	1096.8	1098.5	1100.3	1102.3	1104.5	1106.9	1109.5	1112.2
1115.1	1118.0	1121.3	1124.5	1127.7	1130.9	1134.2			

CALIBRATION/VERIFICATION ERROR - 17.9221

CALCULATED VOLUMETRIC CHANGE - +5.03E+04 (YARDS3)
SIGN CONVENTION: "-" -> EROSION, "+" -> ACCRETION

Figure 29. (Sheet 3 of 3)

SHORC

316. The output file SHORC.DAT holds the "final" calculated position of the shoreline, i.e., the position of the shoreline at the last time step (SIMDATE at Line A.7 in the START file). The format of SHORC.DAT is such that the file can be copied to an input SHORL file holding the "initial" shoreline corresponding to the next stage of a simulation. This file is useful if the configurations of structures change over the course of the simulation period, as described Part V. The objective fitting criterion, quantified by the parameter Y_{diff} , is determined by comparing the calculated final shoreline location held in SHORC.DAT with the measured final shoreline location held in SHORM.DAT. The variable Y_{diff} expresses the mean difference in location between the calculated final shoreline and the corresponding measured one.

Error and Warning Messages

317. After all needed input files are prepared and available to be called by GENESIS, the program can be run. At the beginning of use of the model on a project, it is not uncommon and should not be unexpected to have data mismatch errors, particularly in the START file. GENESIS provides a number of error and warning messages that give the user recovery information for the more common mistakes and notification of potentially undesirable conditions encountered during a simulation. These messages are printed to screen and to the output file SETUP. Error and warning messages and suggested recovery procedures are given in Appendix C.

318. One strategy that has been found useful for reducing errors is to introduce project complexity in the START file in stages, testing (running) the model for a few time steps at each stage. For example, if the project has several structures and beach fills, the START file would first be constructed with only the boundary conditions and tested. Next, perhaps only nondiffracting groins would be placed on the internal grid, if there are such structures. Then, diffracting structures would be introduced. Finally, after successful testing at each stage, the beach fills would be placed in the START file. In this way, errors can be more easily isolated.

Error messages

319. An error message gives information about a "fatal" error, that is, an error detected that would stop the calculation. On the data entry level, these errors might be caused by inconsistencies in specified quantities (for example, specifying three groins but only giving positions for two) or a serious problem in the calculation (for example, running many high waves at extremely oblique incident wave angles). GENESIS is based on physical assumptions and calculation techniques that have limitations (as described in Part V). If these limitations are exceeded, the simulation may fail or give an erroneous result. Experience with GENESIS in a variety of projects indicates it will perform satisfactorily if prudence is taken to represent realistic wave, structure, and shoreline position conditions.

Warnings

320. Warnings are given if a potentially undesirable condition is detected in the course of calculation. One of the more common warnings is that the stability parameter STAB (called " R_s " in the main text) has exceeded the value of 5.0 during a particular time step (see Part V). If $STAB > 5.0$ for too many time steps (as judged by the user) or if a number of STAB values are very large, the calculation is likely to be numerically inaccurate. In this case, the time interval DT should be decreased. The exception to this discussion of STAB is use of GENESIS in scoping or preliminary analysis, for which results need only be qualitative and where large time steps may be desirable to reduce computation time.

PART VII: REPRESENTATION OF STRUCTURES AND BEACH FILL

Types of Structures and Their Effects

321. GENESIS simulates the effects of common coastal structures and engineering activities on the shoreline position. Generic types of structures that can be represented are groins, jetties, harbor breakwaters (with respect to their functioning as a jetty or groin); detached breakwaters; seawalls; and the "soft structure" of beach fill. Considerable flexibility is allowed in combining these basic structures to produce more complex configurations, e.g., T-shaped groins, Y-shaped and half-Y groins, and jetties with spurs. Combinations of these types of structures are also possible.

322. In shoreline change modeling, structures exert two direct effects:

- a. Structures that extend into the surf zone block a portion or all of the sand moving alongshore on their updrift sides and reduce the sand supply on their downdrift sides. Blocking can be direct, as by a groin or jetty, or indirect, as by the calmer region of water in the formed lee of a detached breakwater.
- b. Detached breakwaters and structures with seaward ends extending well beyond the surf zone produce wave diffraction. The diffraction pattern causes the local wave height and direction to change, altering the longshore sand transport rate.

Grid Cells and Numbers of Structures

323. For design mode modeling, it is recommended that at least nine grid points (eight cells) be placed behind detached breakwaters and between adjacent groins. In a scoping mode application or if a wide coastal extent is being covered for which detail at any one structure is not vital, it is recommended that at least four cells be used.

324. Grid spacing in the modeling system should be selected through a balance of the following four conditions:

- a. Resolution desired.
- b. Accuracy of measured shoreline positions and other data.
- c. Expected reliability of the prediction (which mainly depends on the verification and quality of input wave data).

- d. Computer execution time (which depends on the time step, number of cells on the grid, and the simulation interval).

325. The number of structures that can be included in the model depends on the particular configuration of GENESIS which was loaded on the operating system. The configuration was determined on the basis of hardware and software limitations and the intended use. The maximum numbers of grid cells and structures that can be expected in GENESIS Version 2.0 are:

- a. Grid cells: 600.
- b. Groins (total of nondiffracting and diffracting): 70.
- c. Detached breakwaters: 20.
- d. Beach fills: 50.

It should be remembered that execution time increases substantially as the number of diffracting structures increases.

Representation of Structures

326. This section describes capabilities and limitations in representing structures in GENESIS. Idealized examples of plan views of various configurations and the appropriate section of the associated START file are given for reference. The theory of "wave energy windows" and "transport calculation domains," through which GENESIS operates in representing the effects of most types of structures, is given in Part V. It is again noted that structures are represented as infinitesimally thin objects in the model. For example, a groin or jetty is located at the wall of a single cell and cannot occupy the position of more than one wall.

327. Four basic rules governing placement of structures are:

- a. The position of a structure is defined by the location of its tip(s), and these positions are located at cell walls.
- b. If a lateral boundary (at either cell wall 1 or cell wall N+1) is not explicitly specified to be a groin, GENESIS will apply a pinned-beach boundary condition as a default.
- c. There must be at least two cells between groins. As an important special case, a groin cannot be placed in the cell next to a lateral boundary.
- d. The locations of the tips of diffracting structures can coincide (be at the same longshore coordinate), but they cannot overlap.

Legal positioning of structures

328. Figure 30 gives examples of legal placement of structures. Nondiffracting groins may be placed behind a diffracting breakwater (but diffracting groins cannot) (upper left sketch). The other three sketches in this figure show situations involving the tips of two structures sharing the same grid cell. The tip of a detached breakwater and a diffracting groin can be at the same longshore grid cell, as can the tips of two detached breakwaters. The tips of one or two detached breakwaters can be located in the same cell and at the same distance offshore as the tip of a groin to form an angled structure such as a spur groin, Y-groin, angled groin, etc. These types of legal patterns of structures may be repeated along the model reach, as required.

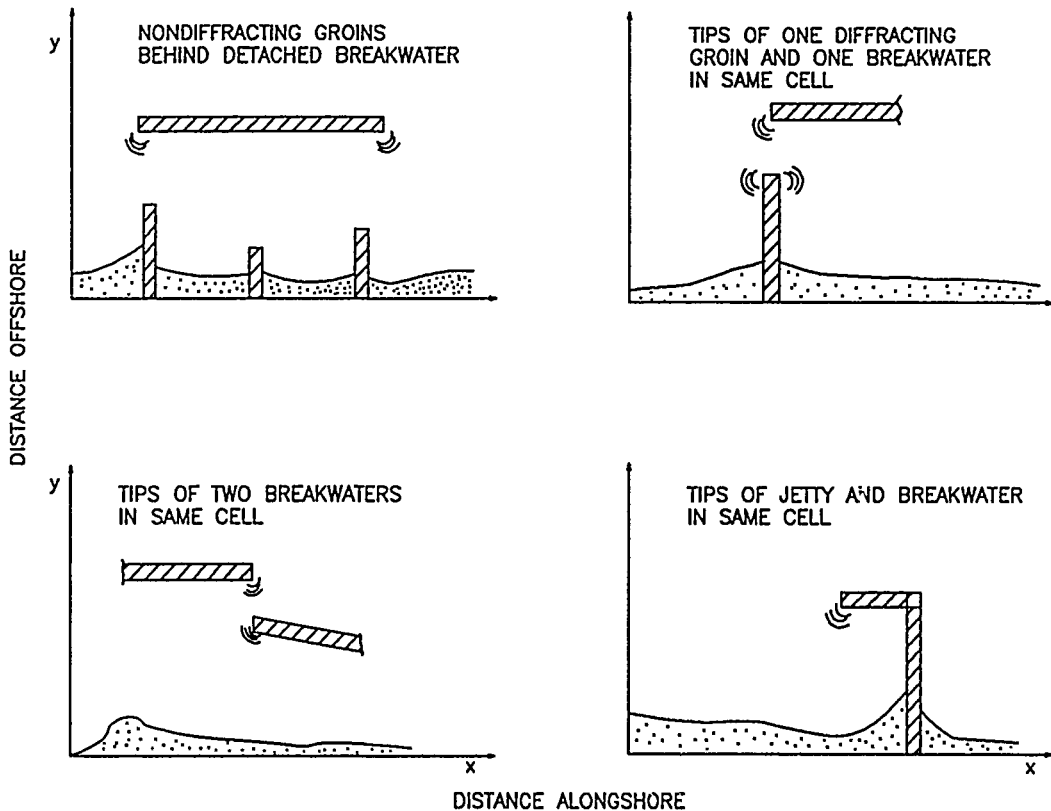

Figure 30. Example legal structure placements

Illegal positioning of structures

329. Figure 31 illustrates the major restrictions on placement of structures. Groins must be placed at least two grid cells apart (upper left sketch). (Since groins in the field are typically placed one to two groin lengths apart, this is not a serious limitation.) A groin cannot be placed in the cell adjacent to a boundary cell, whether the boundary is a groin or a pinned beach (upper right sketch). Diffracting structures of any type cannot overlap (lower left and lower right) (except at their tips; Figure 30).

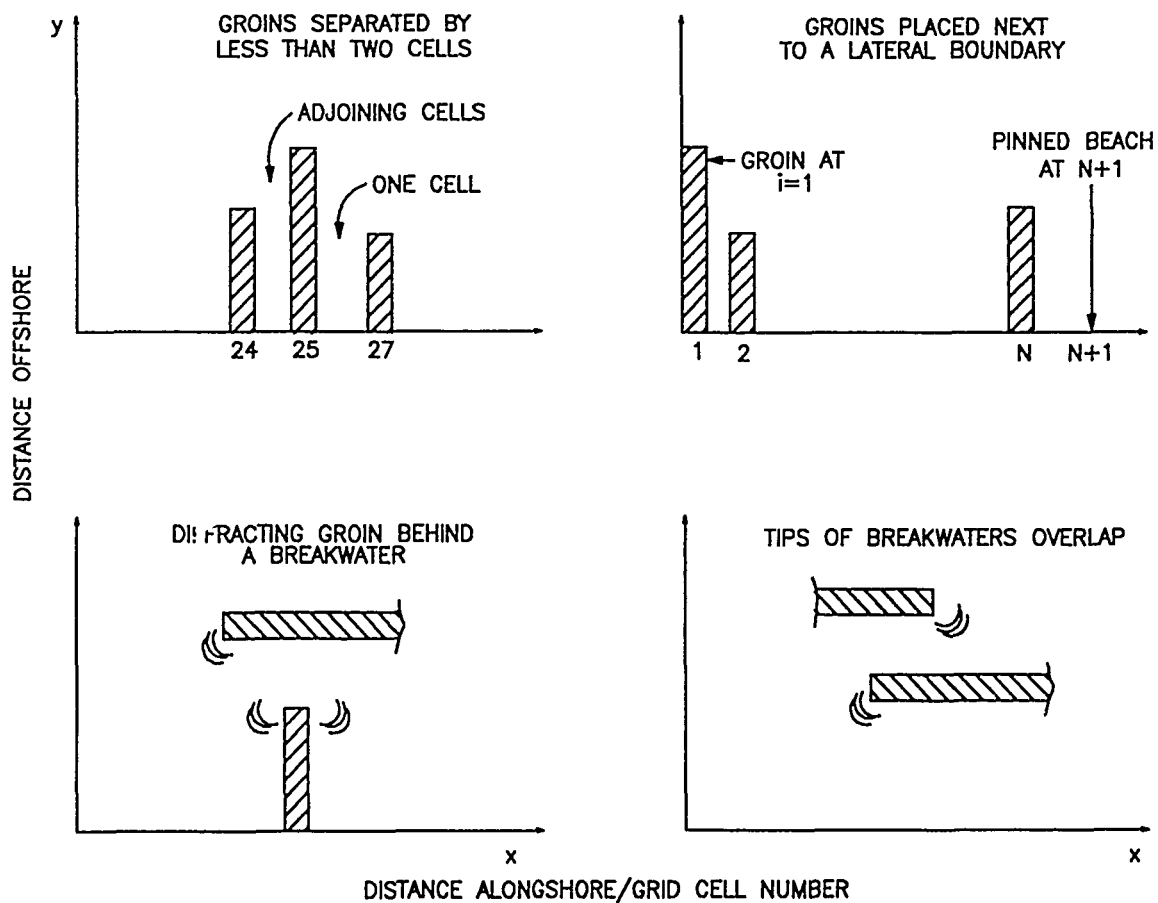

Figure 31. Example illegal structure placements

330. Detached breakwaters. Figure 32 illustrates detached breakwater parameters that may be varied. Detached breakwaters are defined in the modeling system by specifying pairs of ends or tips of the structures in the START file section. (Wave transmission coefficients must also be given.) As a summary, as long as detached breakwaters do not overlap (except for two tips having the same grid cell), the modeler is free to vary the length, transmission coefficient, orientation, distance offshore, and, in the case of segmented breakwaters, the gap width between structures. Detached breakwaters or their equivalent, such as a portion of a harbor jetty, may cross a grid boundary, although this is an unusual and complex case and should be modeled with caution. A groin cannot be placed at the boundary if a detached breakwater crosses it. GENESIS Version 2 will not allow the shoreline to grow to meet a detached breakwater (tombolo formation not simulated). If the shoreline approaches very close to a detached breakwater, the model will fail.

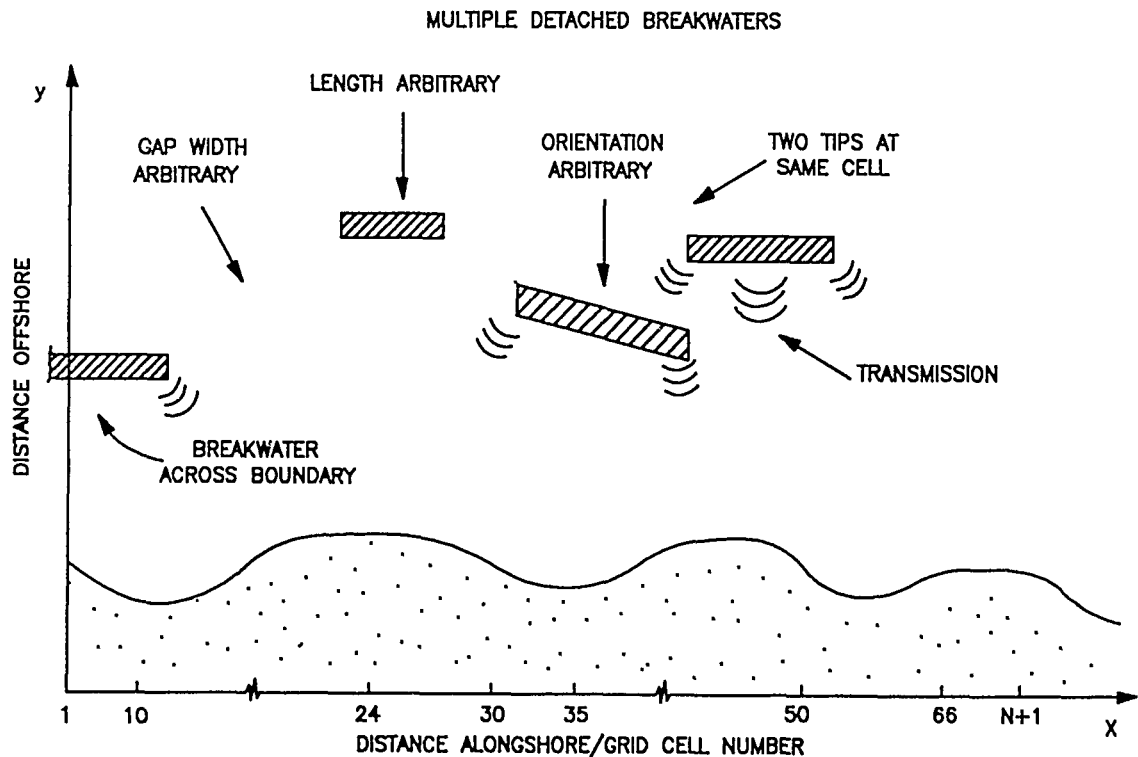

Figure 32. Parameters associated with detached breakwaters

331. Groins. Figure 33 illustrates various legal representations of groins. Simple groins can have arbitrary lengths and are aligned parallel to the y-axis by GENESIS; i.e., angled groins cannot be directly modeled. Groins are assumed to extend a distance landward of -9999 m or ft from the x-axis. A groin cannot be flanked on its landward end; i.e., it cannot be isolated in the surf zone. However, groins can be covered by sand, as may occur during a beach fill; if uncovered by wave action, they will resume functioning.

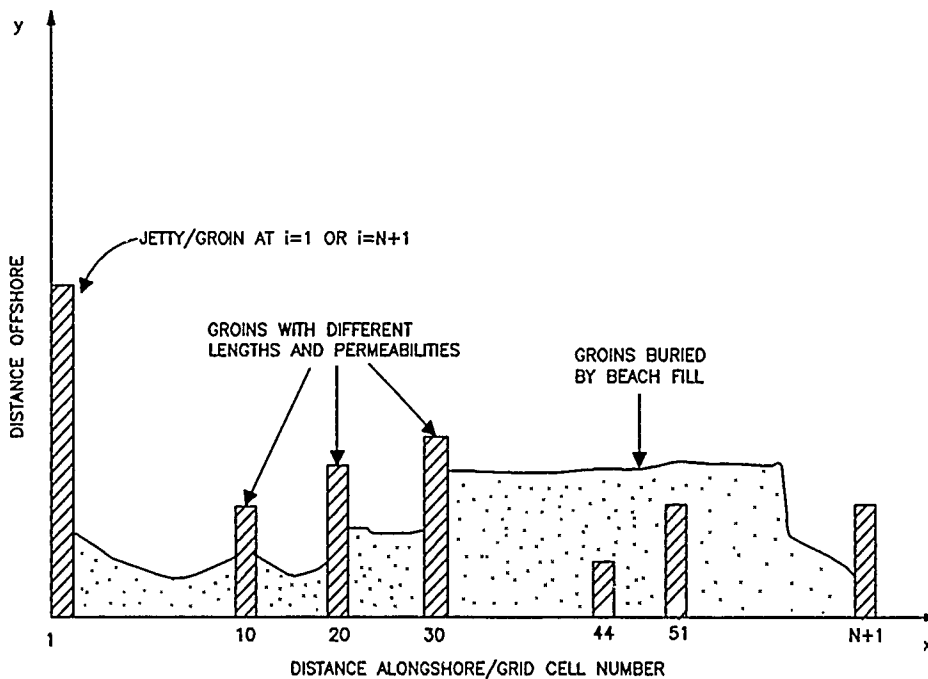

Figure 33. Legal placement of simple groins

Complex Groin Configurations

332. Complex groin or jetty configurations, such as Y-groins, T-groins, and spur jetties, can be represented by placing tips of diffracting groins and detached breakwaters together. Figure 34 shows examples of complex structure configurations that may be represented, and Table 3 shows the corresponding values defining these configurations in the START file.

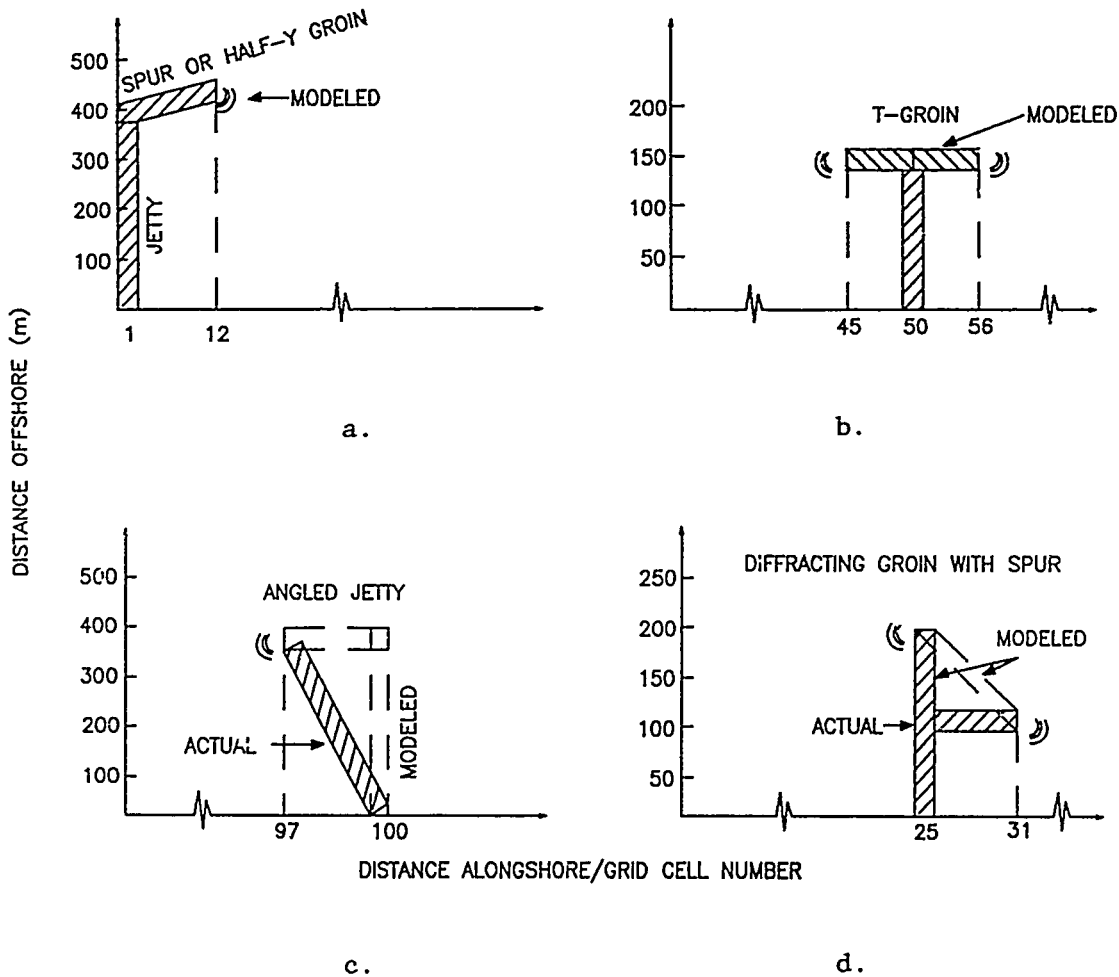

Figure 34. Examples of complex groin and jetty configurations

333. Several features in the examples in Figure 34 deserve attention:
- a. At locations where structures are attached, IX, Y, and D-type variables must be identical. If not, GENESIS will not recognize the structures as being connected.
 - b. The top of the "T" forming a T-groin (such as in example c) must be represented by two structures, each attaching to the diffracting groin. Otherwise, the configuration would be illegal (overlap of diffracting structures) as shown in Figure 31.
 - c. The connection between two detached breakwaters must be at the exact same point in all specifications (as in example c).
 - d. All groins attaching to detached breakwaters must be represented as diffracting.

Table 3

Example Inputs for Complex Structure Configurations in START.DAT*

Variable	Spur Groin (a)	T-Groin (b)	Angled Jetty (c)	Diffracting Groin with Spur (d)
IDG	1	1	1	1
NDG	1	1	1	1
IXDG(I)	1	50	100	25
YDG(I)	350	135	410	225
DDG(I)**	3.1	2.0	3.5	1.7
YGI**	120	-	-	-
YGN**	-	-	630	-
IDB	1	1	1	1
NDB	1	2	1	1
IXDB(I)	1 12	45 50 50 56	97 100	25 31
YDB(I)	350 400	135 135 135 135	410 410	225 135
DDB(I)**	3.1 3.5	1.8 2.0 2.0 2.3	3.7 3.5	1.7 1.3

* See Figure 34.

** Values chosen arbitrarily.

Seawalls

334. Effective sections of seawalls may be defined anywhere on the grid. If several seawall segments are present along the beach, they will be represented by a single seawall separated by areas with locations put at -9999 m or ft (depending on the units chosen) on sections of the beach not protected by a seawall. Figure 35 and the tabulation that follows demonstrate how two short seawall segments are represented in GENESIS. It is noted that the seawall does not need to be straight but may form a "curve" to follow the trend of the beach contours. This is common in placement of a rubble mound, which may be represented as a seawall. The following tabulation gives the y-values in a SEAWL.DAT file designed to describe two seawalls:

-9999	-9999	-9999	-9999	-9999	-9999	-9999	-9999	-9999	60
59	58	57	56	55	54	53	52	51	50
-9999	-9999	-9999	-9999	-9999	-9999	-9999	-9999	-9999	10
10	10	10	10	10	-9999	-9999	-9999	-9999	-9999

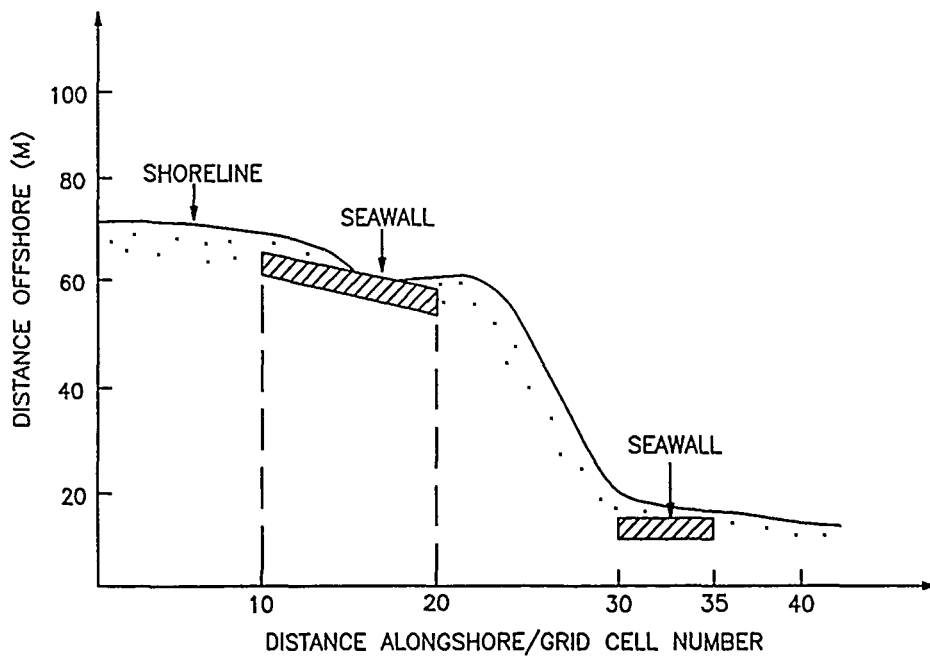

Figure 35. Example illustrating simple seawall configuration

Beach Fills

335. Beach fills may be placed anywhere on the beach and can overlap in time and position. The beach is advanced an equal amount daily at each cell where a given fill has been defined. Beach fills can cover groins, and, if the beach erodes, the groins will become uncovered and begin functioning.

336. The corresponding variable values in START.DAT representing the examples of the beach fills in Figure 36 are:

```

IBF:      1
NBF:      3
BFDATS(I): 890101  890101  890615
BFDATE(I): 890228  890228  890715
IBFS(I):   1      10     20
IBFE(I):  30     20     60
YADD(I):  20     5      5
  
```

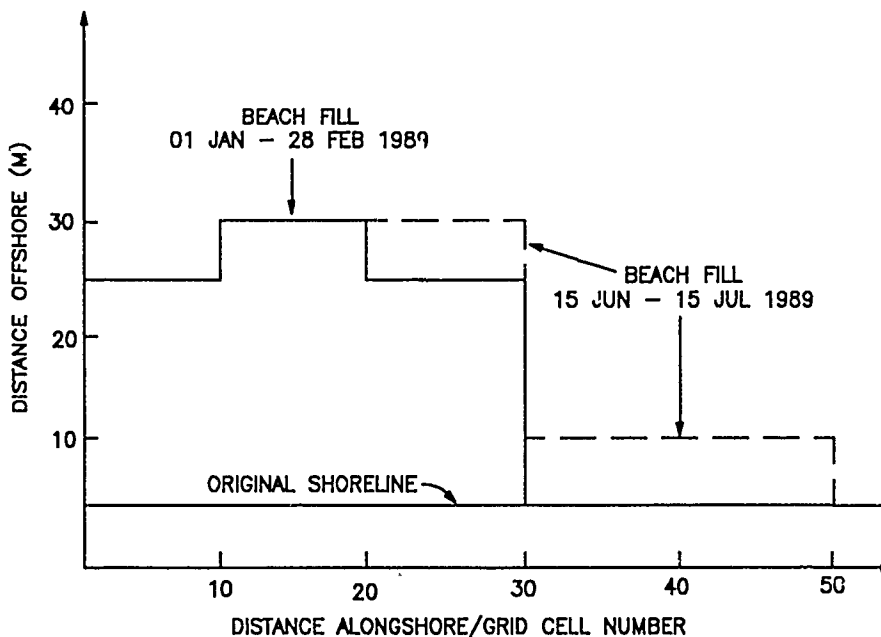

Figure 36. Example illustrating simple beach-fill configuration

337. As an alternative to representing the first fill by a 20-m fill from grid cell 1 to grid cell 30 superimposed by a 10-m fill from grid cell 10 to grid cell 20, it can also be represented by three attaching fills. The alternative values in START.DAT would then be:

```

IBF:      1
NBF:      4
BFDATS(I): 890101  890101  890101  890615
BFDATE(I): 890228  890228  890228  890715
IBFS(I):   1      10     20     20
IBFE(I):  10     20     30     60
YADD(I):  20     25     20     5
  
```

338. It should be noted that all values in a column must refer to the same fill. This means that the values on a row may not always appear in consecutive or chronological order.

Time-Varying Structure Configurations

339. In many modeling projects, structures are built, modified, removed, or destroyed during the course of a shoreline change simulation period. The simulation must be performed in stages in such a case. A START file with the initial configuration would run GENESIS until the time step of the change in a structure; the SHORC file (calculated shoreline) from this first stage would then be copied to a SHORL file (initial shoreline) for the next stage of the simulation, and another START file describing the new configuration would be used to continue. This procedure can be chained for describing any number of modifications in structure configurations and boundary conditions. Most computer systems allow creation of a batch file to automate the chaining of calculation segments.

PART VIII: CASE STUDY OF LAKEVIEW PARK, LORAIN, OHIO

Background

340. This chapter presents a case study that exercises GENESIS and the skill of the modeler in a realistic way for an actual project. The project, Lakeview Park, is located on the southeast shore of Lake Erie, in Lorain, Ohio (Figure 37). The park lies about one-half mile west of Lorain Harbor, a prominent feature along the coast that includes breakwaters extending lakeward almost a mile from shore. This coast has a limited source of beach sand and consists of eroding glacial till bluffs, narrow pocket beaches, and armored stretches with no beach at all. Under these conditions the municipality of Lorain wished to protect the existing park and provide a recreational beach.

341. Documentation on the Lakeview Park project is substantial, but wave information is lacking and had to be synthesized by the modelers through use of a wave hindcast and limited gage data. The project is sufficiently localized and simple to be encompassed in an illustrative case study without excessive detail and demands on computer resources, yet it highlights many features of GENESIS. The case study was performed for instructional purposes and not for design, with expedients taken to reduce the level of effort.

342. The project and monitoring results have been well documented. Authoritative and complete information on the project design and both local and regional coastal and geologic processes is contained in the General Design Memorandum (GDM) for the project (US Army Engineer District (USAED), Buffalo 1975). Walker, Clark, and Pope (1980) summarize the purpose and setting, regional and local coastal and geologic processes, design procedure for the project, and results of early monitoring. Pope and Rowen (1983) report results of a 5-year monitoring program at the site, evaluating project performance through calculation of sand volume and shoreline position change. These studies provide considerable information on waves and water levels, storms, geology, and sand transport in the region and at the project, furnishing the necessary "coastal experience" for the case study. The information

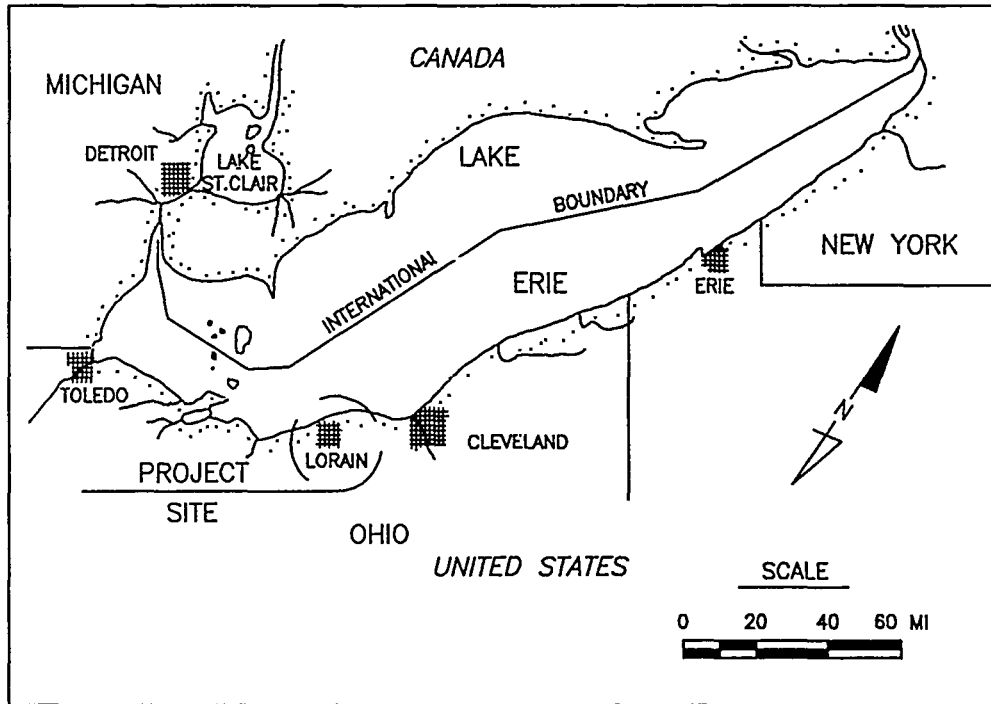

a. Location map

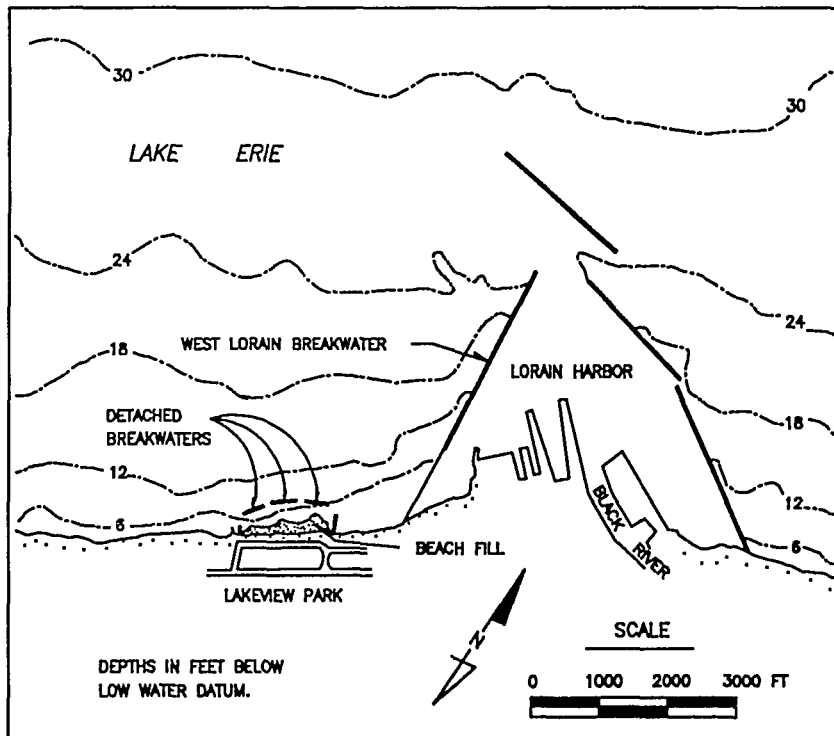

b. Planview detail

Figure 37. Location map for Lorain, Ohio

these three studies contain is selectively summarized here so that the reader can understand the modeling procedures in context. Most of the background material in this chapter was derived from the three studies.

343. Maintenance of a stable beach in a coastal environment such as at Lorain would require placement of fill and periodic renourishment. However, a small beach fill would be rapidly depleted by longshore transport, suggesting that the constructed beach should be enclosed by groins. Groins will have minor impact on the neighboring shore, since there is effectively no sand moving along the coast and no neighboring beaches to protect. The cross-shore component of sand transport must also be considered. The wave climate in the Great Lakes is dominated by short-period high waves generated over narrow fetches by frequent small storms. The resultant steep storm waves tend to transport sand offshore, and there is no completely compensating counterpart of persistent long-period swell waves of summer which tend to transport sand onshore, as is the case on an open coast facing an unlimited ocean fetch. Since the coast is deficient in sediment, sand moved offshore tends to disperse and does not return to the original location. It is logical to think of protecting the fill with detached breakwaters to reduce wave energy arriving to the beach and to prevent sand from moving offshore.

344. Such a project was constructed at Lakeview Park in October 1977 (Walker, Clark, and Pope 1980; Pope and Rowen 1983) and was the first detached breakwater system specifically built in the United States to stabilize a recreational beach (Dally and Pope 1986). Figure 38 is an aerial photograph of the site.

345. The net direction of regional longshore sand transport along this coast tends to be from east to west, as may be inferred from the lengths of fetches in Figure 37, with an annual potential rate estimated to be about 60,000 cu yd. However, due to sheltering of easterly waves by the Lorain Harbor breakwaters, the potential net transport rate at Lakeview Park is from west to east at an estimated 21,500 cu yd per year, but with an actual transport rate of only 5,000 to 8,000 cu yd per year due to lack of sediment. Because of the limited natural supply of beach sand, the coast has suffered from chronic erosion, and, for portions of the unprotected coastline, erosion

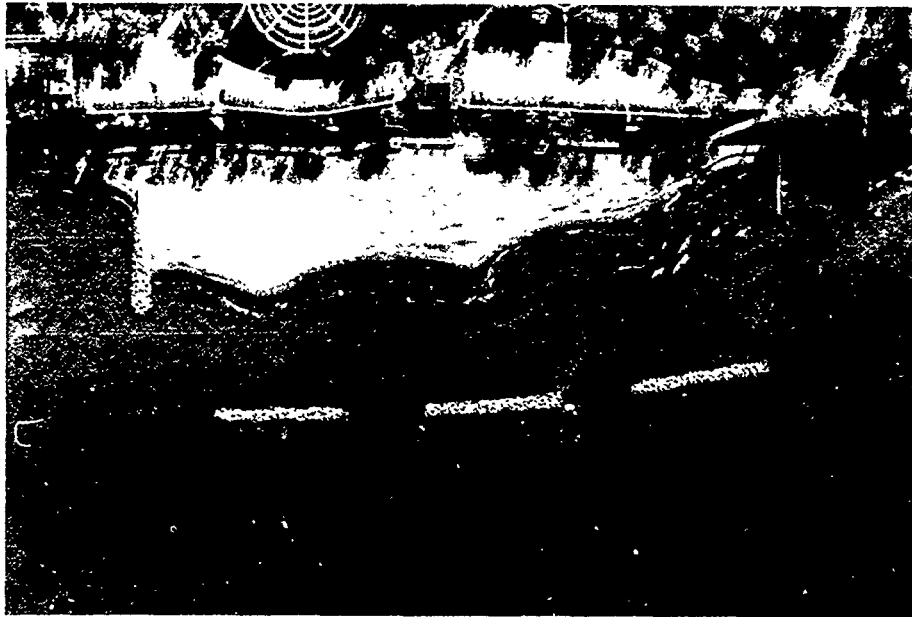

11-17-79

Figure 38. Aerial view of Lakeview Park, 17 November 1979

continued during recent high lake levels which lasted from the early 1970's through the monitoring period. Lake level peaked in 1973 and again in 1986.

346. In earlier attempts to protect private and public property, groins and a seawall were built and repeatedly repaired with only limited success to halt shore erosion. Storm waves and high lake levels during the 1970's damaged the coast, and the seawall protecting Lakeview Park with its bathhouse was undermined and collapsed.

Existing Project

347. To meet the project goals, a plan that included a beach fill, groins, and detached breakwaters was developed in 1974 in a 1-year study that did not involve use of either mathematical or hydraulic models, leading to a comprehensive GDM (USAED, Buffalo 1975). The project was completed in October 1977, and a 5-year monitoring program was begun. The fill was designed to protect the park and serve as a recreational beach; the detached breakwaters

and groins were designed to protect the fill. The project has been a success; the beach is effectively stable, and the rate of replenishment during the first 5 years after completion of the project in October 1977 was only approximately 35 percent of the predicted.

Structures and beach fill

348. As shown in Figure 39, the project consists of three rubble-mound detached breakwaters and two groins that contain a sandy beach created by a fill. Since the project was designed in American customary units, those units were selected in the modeling and are used in the following discussion. The length of the beach, defined by the distance between groins, is 1,250 ft, and the nominal distance from the revetment at the park to the breakwaters is 500 ft. The breakwaters are 250 ft long and separated by 160-ft gaps. Water depth at the breakwaters is about 10 to 13 ft, depending on lake level. The breakwaters have a crest height of 6 ft above the long-term average lake level. The western groin, made of concrete, is 164 ft long, and the eastern, composite concrete and rubble-mound groin is 360 ft long and is intended to prevent sand from leaving the project. Except for a small groin compartment on the west side of the project, the neighboring shore is almost devoid of a subaqueous beach.

349. The initial beachfill volume was 110,000 cu yd and had a +8-ft berm elevation. After placement of the fill, the beach near the west groin eroded, and this area was replenished with 6,000 cu yd in July 1980 and another 3,000 cu yd in September 1981. However, the overall fill was surprisingly stable and even experienced a slight volume gain of about 3,000 cu yd per year (excluding the two extra fills) over the 5-year monitoring program. In design of the project, the annual loss was predicted to be 5,000 cu yd, representing 5 percent of the initial fill volume. The project has clearly satisfied the two design criteria of protecting the park and providing a recreational beach facility. Aerial photographs indicate that the project has minimal impact on the neighboring shore.

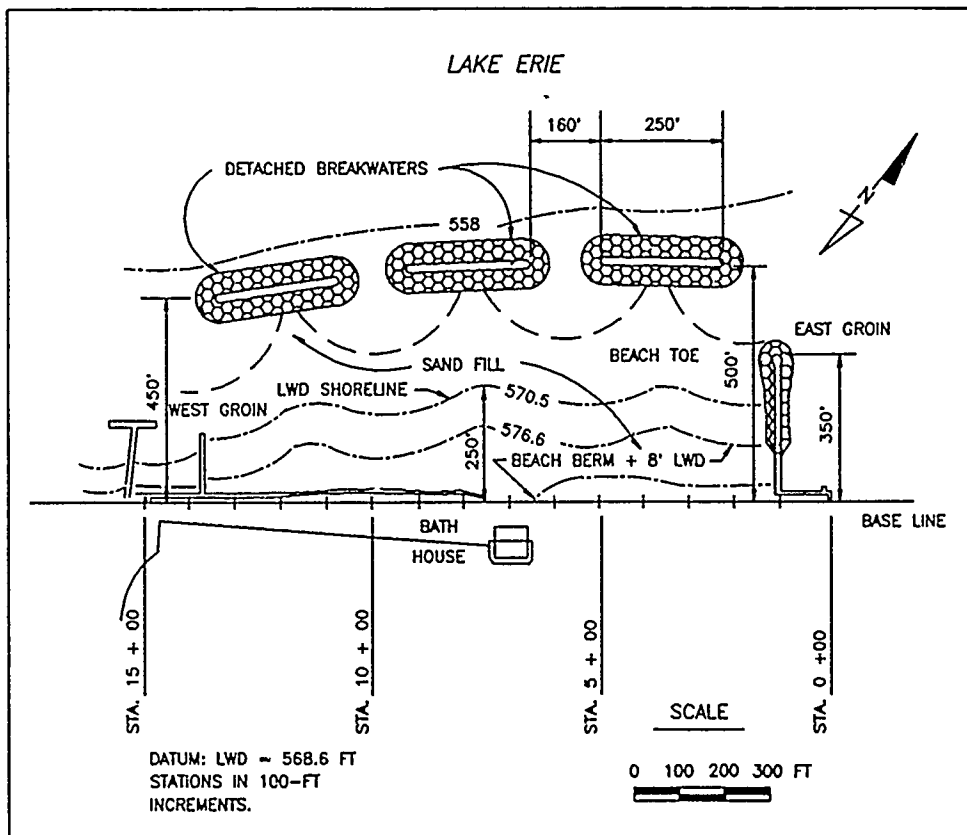

Figure 39. Project design, Lakeview Park

Sediment

350. The native beach material was characterized as being composed of fine, well-sorted quartz sand, whereas the fill material was coarser (medium-fine), consisting of only 50-percent quartz grains and much more poorly sorted. The fill material was found to predominate in the area landward of the detached breakwaters after completion of the project. Samples indicated that the bottom out to 300 ft offshore consists of medium to coarse sand with gravel.

351. Repeated sediment sampling during the 5 years following the initial beach placement indicated that native sand is entering the west side of the project site, and sand is moving out of the site at a lower rate across the eastern boundary. There was no indication of sand being transported offshore between the detached breakwaters.

Water level and shoreline position

352. Although Lake Erie does not experience an astronomical tide, lake levels vary because of short- and long-term climatic changes. During the 5-year monitoring period, the highest recorded monthly mean level was 4.9 ft above low water datum (LWD), and the lowest was 1.1 ft below LWD. (In 1986, a new record high of 5.1 ft was established.) The greatest annual fluctuation of monthly mean lake level was 2.75 ft, and a 1.5-ft surge was calculated to have a recurrence interval of 1 year.

353. Suggestions of sinuous topographic development were noted during the process of placing the fill, indicating a strong tendency for the beach to adjust to the wave and current pattern produced by the breakwaters. In the 6-month interval between construction in October 1977 and May 1978, the shoreline shape matured, and after approximately 1 year the planform was in an equilibrium shape with a salient behind each detached breakwater. Aerial photography shows well-formed salients during the lower lake levels in fall; these become partially submerged and subdued during higher lake levels in spring.

Wave climate

354. A 3-year wave hindcast was performed by Saville (1953) for Cleveland, Ohio, located 28 miles east of the project site. With modifications for differences in fetch and water depth, these data can be applied to Lorain. The average wave height and period in the hindcast are 1.5 ft and 4.7 sec. The maximum annual wave height is close to 8 ft, with periods up to 7 sec. For calculation of shoreline change, waves are assumed to transport sand only during an ice-free period from 1 April through 30 November.

Assembly of Data

355. Appendix D contains printouts of the input data files used in the initial testing of the model and in final calibration and verification. The OUTPT files are also given. Appendix D can be consulted for specifics associated with the discussion of the case study.

Data for the START file

356. The initial model configuration is contained in START_INIT. The data in START_INIT represent the first modeling conceptualization of the site. As discussed below, values for many quantities were taken from aerial photographs, whereas other data represent only an initial estimate. Values of selected entries are now reviewed.

357. Line A.3. The lengths of the detached breakwaters are 250 ft and the gaps between them 160 ft. Good resolution requires about 10 cells per breakwater and about 4 cells in the gaps, leading to $DX = 25$ ft as a reasonable value for describing detail of the breakwater configuration, yet not giving an excessive number of calculation cells.

358. Line A.5. Because the wave data set was constructed with values at 6-hr intervals, as will be discussed below, the time interval $DT = 6$ hr is taken as a first guess. However, warnings of high values of the stability parameter R_s (STAB) are expected, since experience indicates that $DX = 25$ ft is relatively small for use with a 6-hr time interval. The convenient $DT = 6$ hr is tried to see how large the value of the stability parameter will be under the wave conditions. If high values of R_s occur, the value of DT will be reduced until R_s falls below 5 or few stability warnings occur.

359. Line A.12. The values of $K1$ and $K2$ will be determined in the calibration process. As a first guess, nominal values are chosen. The value of 0.77 is associated with the potential sand transport rate of about 21,500 cu yd/year. As the actual annual rate is much lower, the calibrated value of $K1$ is expected to be smaller than 0.77.

360. Line B.1. The values of these change parameters may be altered at a later stage, but, as a rule, they are initially set to give no change.

361. Line C.1. The native sand has a median grain size in the range of about 0.15 to 0.20 mm. However, the median grain size of the fill material is 0.40 mm, so the latter value is used, since the fill predominates.

362. Line C.2. The design indicates the initial beach fill was placed with a berm elevation of 8 ft.

363. Line C.3. The depth of closure is estimated to be twice the maximum annual wave height, which for Lakeview Park is 8 ft according to available wave data, giving a depth of closure of 16 ft.

364. Line D.1. Because the two groins are relatively short, they are specified to be nondiffracting. (In the process of model calibration, the groins can be easily changed to be diffracting to check model sensitivity to this assumption.)

365. Lines D.4 and D.5. The configurations of the groins are read from aerial photos and checked with construction plans.

366. Line F.2. Profile surveys made from October 1977 through November 1979 showed that the bottom slope was about 1:20 behind the detached breakwaters and 1:15 in the region of the gaps between the breakwaters. The chosen slope, taken as an average for the whole area, is 1:18.

367. Line F.3. The east groin was built to be tight to prevent sand from leaving the beach. It is assumed that permeability of the groins is low and little sand transmission by overtopping occurs.

368. Lines F.4 and F.5. The amount of sand entering the project area from the lateral boundaries is primarily controlled by the values assigned to the lengths of the groins as measured from the shoreline position on the outer side of the grid. Initial values of these lengths are taken from the aerial photographs, but might change slightly during model calibration to achieve optimal gating of sand across the boundary.

369. Lines G.6 and G.7. Geometrical properties defining the breakwaters are conveniently taken from aerial photographs.

370. Line G.9. The breakwaters are of standard layered rubble-mound design (SPM 1984) and nongrouted; therefore, they are expected to be somewhat permeable to incident waves. Also, during periods of high water levels and high waves, wave transmission by overtopping will take place. The breakwaters are expected to have relatively small values of transmission coefficients that should be the same since the breakwaters were constructed of the same type of stone and by the same procedure. However, the different water depths at the breakwaters will change transmission properties, as will slight differences in stone placement and structure settling. As an initial guess, the three transmission coefficients are set to zero with the expectation that these values will change.

371. Line I.1. Beach fills were placed before as well as after the simulation interval, but not between the dates of the shoreline (aerial)

surveys selected for modeling. Therefore, a value indicating no beach fills was given on this line.

Data for the SHORL files

372. There are several ways of obtaining shoreline positions, for example, from closely spaced beach profile surveys, shoreline surveys, stereoscopic photogrammetry, and controlled aerial photography. Numerous sets of vertical aerial photographs were available to this study for which the water level was known. From these photographs, the shoreline position was digitized with respect to an arbitrary straight baseline drawn along the revetment and parallel to the trend of the coast. The digitization was done by hand because the longshore extent was short. Through a field investigation, the average distance between the contour defining the water level and a shoreline datum was determined for representative portions of the modeled beach. These distances were then added to or subtracted from the distances determined in the digitizing operation.

373. Aerial photographs were available for biannual flights flown between 1 October 1977 and 18 September 1984. Among these, three were chosen for use in this case study: 24 October 1977, 9 October 1978, and 17 November 1979. No beach fills were placed between October 1977 and 1980, making this period uncomplicated and most suitable for simulations. The scale on the available photographs was about 1:2,300 as determined from known lengths of structures; these photographs were enlarged to a scale of 1:1,500 for hand digitization, allowing shoreline position to be determined to the nearest foot. An average error of 1 ft in shoreline position corresponds to a volumetric error of 1,100 cu yd $[(8+16)1,250/27]$.

374. Pope and Rowen (1983) reported average lake levels for the dates of the selected aerial photographs to be 2.6, 2.4, and 2.5 ft, respectively. The initial slope of the fill was 1:5, gradually approaching 1:12 during the first 6 months after placement. By using an average foreshore slope of 1:12, horizontal distances of 31.2, 28.8, and 30.0 ft, respectively, were added to the digitized positions to estimate the true location of the shoreline. As GENESIS cannot account for this transient profile adjustment, the transition from the steeper to the gentler slope was assumed to have taken place at the start of simulation on 24 October 1977. This transition was schematized and

included in the shoreline location of 24 October. The profile was represented by a straight line from the top of the berm at +8 ft to the depth of closure, -16 ft. Further, the transition was assumed to rotate the profile around its center, i.e., at -4 ft. Geometry then gives the setback associated with a slope change from 1:5 to 1:12 to be 28 ft. This distance was subtracted from the values representing the shoreline of 24 October 1977.

375. Walker, Clark, and Pope (1980) also report volumetric changes within the project boundaries between the dates of the aerial photographs used here. From October 1977 to October 1978, the project gained approximately 4,300 cu yd, whereas from October 1978 to November 1979 about 400 cu yd were lost. Corresponding comparisons were made using the shoreline position files, which indicated a gain of 13,500 cu yd from 1977 to 1978 and a loss of 6,900 cu yd from 1978 to 1979. Using the 1977 shoreline as a reference, these volume changes convert to an average error of 8.4 ft (1 mm on the aerial photographs) in determination of the 1978 shoreline and an error of 2.7 ft (0.3 mm on aerial photographs) for the 1979 shoreline. To be consistent with previous studies, the 1978 and 1979 shoreline positions were translated forward 8.4 and 2.7 ft, respectively, resulting in volumetric differences of 4,260 cu yd from October 1977 to October 1978 and -335 cu yd from October 1978 to November 1979. The adjusted measured shoreline positions are shown in Figure 40, and the corresponding SHORL files are given in Appendix D. As seen from Figure 40, the general trend is for erosion along the western part of the study area and accretion in the eastern part.

376. Figure 41 plots measured volumetric changes within the study area using the October 1977 volume as a reference. The volumetric change varies significantly with season, with a gain of sand over the winter and a loss during the summer. Contrary to what might be expected, the seasonal variations appear to increase in time, rather than approaching an equilibrium. The increase is probably explained by long-term variations in wave climate and water level. Also, there are significant changes in beach volume from year to year, although the general trend is accumulation for the fall and spring measurements, with a least-squares determined value of 2,500 and 3,500 cu yd/year, respectively.

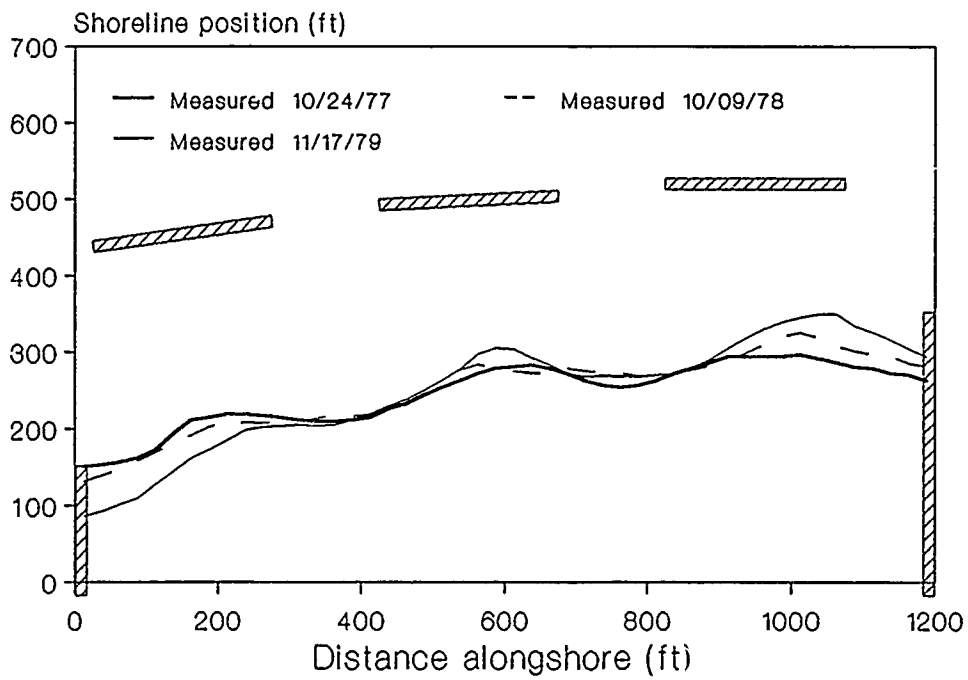

Figure 40. Adjusted measured shoreline positions

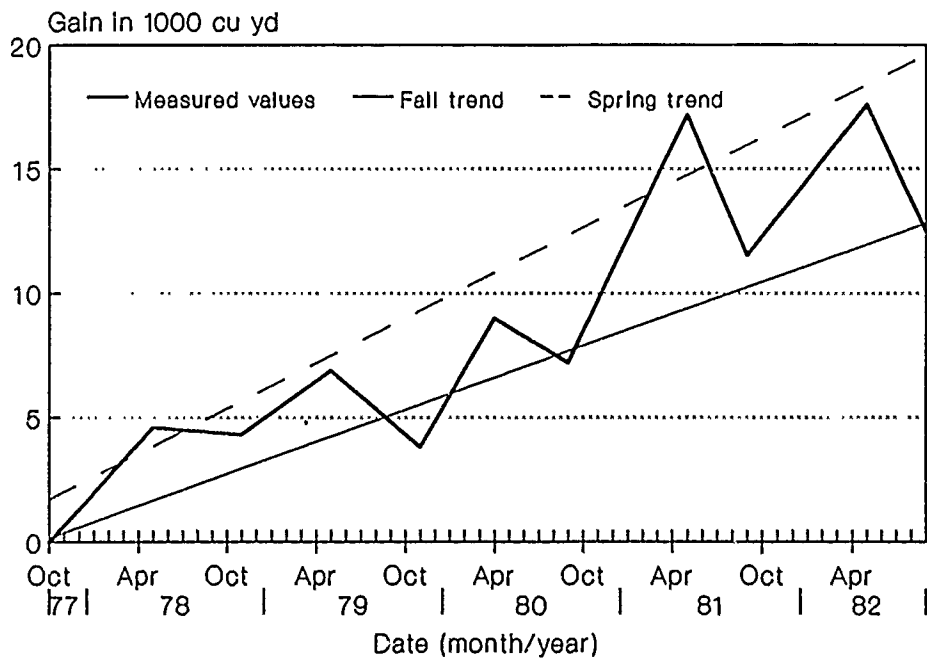

Figure 41. Measured volume changes within the study area

Data for the SEAWL file

377. The seawall in the model was placed at the location of the seawall running along the beach, as read from the aerial photographs. The SEAWL file is given in Appendix D.

Data for the DEPTH file

378. A DEPTH file was not required because an external wave transformation model was not used. The reasoning was that diffraction from the breakwaters was considered to be the dominant wave transformation process, and alongshore variations in breaking wave height and direction because of wave refraction over the relatively plane and parallel offshore bathymetry would be comparatively small.

Data for the WAVES file

379. As in most shoreline change modeling studies, wave measurements for the site for the time interval between measured shoreline positions were not available. Instead, a well-known 3-year wave hindcast for Lake Erie for the period 1948-1950 was used (Saville 1953) and checked for general trends with readily available gage data. The hindcast, presented in tabular form, was originally developed for Cleveland, Ohio, located 28 miles east of Lorain. Also, a more recent wave data time series of height and period was available from a gage located in 30 ft of water off Cleveland Harbor for the period September to November 1981. The gage data were used to modify the time series developed from the hindcast in three stages, as discussed below.

380. Breaking waves are the principal driving force for longshore sand transport. Therefore, an effort must be made to prepare a wave data set with properties that produce reasonable transport rates. For this case study, the GDM (USAED, Buffalo 1975) provided the basic information about the general sediment transport condition in the area. Key findings used for guidance in preparing the wave data set were:

- a. Far from the influence of wave sheltering by Lorain Harbor, the net transport in the area is estimated to be from east to west with an annual rate of about 60,000 cu yd.
- b. Because of sheltering of waves from the west by Lorain Harbor, the net transport at Lakeview Park is from west to east with an estimated net potential rate of 21,500 cu yd per year. The estimated annual gross potential rate is about 164,000 cu yd.

- c. Because of a limited supply of sand, the potential transport rates are not realized. The actual net transport rate is estimated to be in the range of 5,000 to 8,000 cu yd/year.
- d. Significant sand transport can occur only during the ice-free period from April through November. During the remainder of the year, the wave height should be considered as being effectively zero for the purpose of shoreline change modeling.

381. The first step was to produce a time series of offshore wave period, height, and direction data using tables presented in Saville (1953). For the ice-free period, the hindcast wave climate was defined as "calm" for as much as 73 percent of the time. However, the modelers believed that some wave activity must occur during at least a portion of the hindcast calm periods. As a compromise, in development of the wave time series for this case study, a "calm" deepwater wave condition was initially defined as $T = 2$ sec, $H = 1$ ft, and $\theta = 0$ deg. Sample lines from the initially prepared file WAVES_INIT are listed in Table 4, in which lines of WAVES files modified as will be discussed below are given for comparison.

Table 4
Sample Entries Illustrating Development of the WAVES File

<u>WAVES-INIT</u>			<u>WAVES-2T</u>			<u>WAVES-CNG</u>			<u>WAVES-DIFF</u>		
<u>T</u>	<u>H</u>	<u>θ</u>	<u>T</u>	<u>H</u>	<u>θ</u>	<u>T</u>	<u>H</u>	<u>θ</u>	<u>T</u>	<u>H</u>	<u>θ</u>
<u>sec</u>	<u>ft</u>	<u>deg</u>	<u>sec</u>	<u>ft</u>	<u>deg</u>	<u>sec</u>	<u>ft</u>	<u>deg</u>	<u>sec</u>	<u>ft</u>	<u>deg</u>
4.5	5.00	-53	8.0	5.00	-53	8.0	6.00	-53	8.0	3.06	-33
3.0	2.00	-30	6.0	2.00	-30	6.0	2.40	-30	6.0	1.76	-30
3.0	2.00	-8	6.0	2.00	-8	6.0	2.20	-8	6.0	1.93	-8
2.0	1.00	0	4.0	1.00	0	4.0	1.00	-10	4.0	0.86	-10
3.0	2.00	15	6.0	2.00	15	6.0	1.80	15	6.0	1.75	15
3.0	2.00	38	6.0	2.00	38	6.0	1.60	38	6.0	1.60	38
4.0	3.00	60	8.0	3.00	60	8.0	2.40	60	8.0	2.40	60

382. From the time series developed for the WAVES.INIT data file, wave climates for September, October, and November were extracted and compared with the measured time series from 1981. Table 5 shows a comparison between wave properties measured in 1981 and those based on the hindcast of Saville (1953).

Table 5

Comparison Between Measured and Hindcast Waves

Month	Measured Waves		Hindcast Sep - Nov		Comparison Sep - Nov		Hindcast Apr - Nov		Comparison Apr - Nov	
	H ft	T _p sec	H _h ft	T _h sec	H/H _h	T _p /T _h	H _h ft	T _h sec	H/H _h	T _p /T _h
Sep	1.2	4.7	1.5	2.4	0.8	1.9	--	--	--	--
Oct	2.0	4.9	1.4	2.3	1.4	2.1	--	--	--	--
Nov	1.6	4.7	1.7	2.5	0.9	1.9	--	--	--	--
AVG	1.6	4.7	1.5	2.4	1.0	2.0	1.5	2.4	1.0	1.9

Note: H = measured significant wave height; T_p = measured peak wave period; H_h = hindcast significant wave height; T_h = hindcast significant wave period.

383. As seen from Table 5, there was good agreement between wave heights for the two data sets, whereas the period for the measured waves is about twice that of the hindcast. Assuming that the measurements are representative, the hindcast was modified by multiplying the periods by a factor of 2, with the constraint that the wave period could not be greater than 8 sec. The result of this transformation to a new wave data file called WAVES_2T is illustrated by sample lines in Table 4.

384. The GDM (USAED, Buffalo 1975; Walker, Clark, and Pope 1980; Pope and Rowen 1983) derived estimates of the longshore sand transport rates described above using an equation similar to Equation 2 with K₁ = 0.77 and K₂ = 0.0. Therefore, to be compatible with the original estimates made by specialists who knew the coast, the same values were used to calculate annual potential transport rates for a straight shoreline without structures. The calculated rates should correspond to the previously reported potential rates. Table 6 shows selected calculated transport rates obtained using the modified WAVES file.

385. As shown in Table 6, with a positive transport rate defined from west to east, the calculated annual net transport rate was of the correct

Table 6
Calculated Annual Potential Transport Rates

<u>Wave Direction</u>	<u>Angle to Shoreline deg</u>	<u>No. of Events</u>	<u>Net Rate 10³ cu yd/year</u>	<u>Gross Rate 10³ cu yd/year</u>
NNE	-53	55	-41	--
N	-30	49	-26	--
NNW	-8	47	-18	--
CALM	0	713	0	--
NW	15	37	23	--
WNW	38	49	76	--
W	60	26	38	--
All Directions		976	51	224

order of magnitude, but in the wrong direction. No information was available for comparing the calculated gross transport rate. Several factors in the derivation of the wave time series might account for the difference between the present and previously calculated net annual transport rates: the simplified method of hindcasting the waves in producing the wave tables; the somewhat arbitrary development of the time series from the hindcast statistics; and the assumption that the 3-year period 1948-50 is fully representative for the situation after 1977. But the major reason for the difference is probably that the wave data set pertains to Cleveland and does not account for local characteristics at Lorain. In particular, as the fetch for westerly waves is shorter for Lorain, waves from the west are expected to be smaller at Lorain than at Cleveland.

386. Taking all these factors into account, the wave height in the time series was modified by multiplying by the following values (representing educated guesses to produce the desired effect) according to direction to develop a new wave time series: 0.8 (W), 0.8 (WNW), 0.9 (NW), 1.0 (calm), 1.1 (NNW), 1.2 (N), and 1.2 (NNE). Also, during periods of the modified calm conditions as described above, the offshore wave direction was set to -10 deg to the trend of the shoreline rather than perpendicular to better represent the longer fetch to the northeast. The transformation to the new wave data file WAVES_CNG is illustrated by sample lines in Table 4. Using the new wave

time series, the annual net transport rate was calculated to be -57,000 cu yd, and the gross rate was calculated to be 227,000 cu yd. Thus, agreement with the net rate of -60,000 cu yd as given in the GDM (USAED, Buffalo 1975) is now very good.

387. The next step in preparation of the WAVES input file was to include the shadowing or diffraction effect of Lorain Harbor. However, because of the limited size of the Lakeview Park project and the considerable distance between it and the lakeward ends of the harbor structures, it was not possible to include the effect of the harbor directly in simulations by GENESIS. Instead, a computer routine was written to recalculate a new offshore wave time series, including the influence of the harbor. At each 6-hr interval in the wave time series, the routine read the triplet (T, H_o, θ_o) at the 30-ft contour, transformed the wave conditions to the depth of the outer breakwater tip (28 ft), and calculated a representative diffraction coefficient K_D for the Lakeview Park region following the procedure described by Kraus (1984, 1988). A modified offshore wave height was then calculated as $H' = K_D H_o$. Also, the wave angle was restricted to be greater than -33 deg, representing the line between the outer breakwater tip and Lakeview Park. The resultant modified wave heights by direction are summarized in Table 7.

388. The transformation to the modified wave data file WAVES_DIFF is illustrated with sample lines in Table 4. Using this new time series to represent wave conditions at Lakeview Park, the annual net transport rate was calculated to be 22,000 cu yd, and the gross rate was calculated to be 144,000 cu yd. Thus, agreement with the previously obtained net rate of 21,500 cu yd and the gross rate of 164,000 cu yd is good.

389. In summary, through use of third-party coastal experience at the site together with modeling judgment, the original file WAVES_INIT was modified in a series of steps to arrive at WAVES_DIFF, which was developed to have desirable properties for serving for calibration and verification of GENESIS. Being satisfied with premodeling testing of the wave time series, WAVES_DIFF was copied over to serve as the input wave file WAVES.DAT (Appendix D) to drive GENESIS.

Table 7
Modified Average Wave Height Because of
Shadowing by Lorain Harbor

<u>Wave</u> <u>Direction</u>	<u>Original</u> <u>H_o</u> <u>ft</u>	<u>Modified</u> <u>H'</u> <u>ft</u>	<u>H'/H_o</u>
NNE	2.53	1.24	0.49
N	2.41	1.78	0.74
NNW	2.64	2.37	0.90
CALM	1.00	0.90	0.90
NW	3.03	2.92	0.97
WNW	3.31	3.27	0.99
W	3.27	3.26	0.99
All	1.49	1.29	0.87

Calibration and Verification

390. The calibration and verification process in a design situation requires a large number of simulations. Values of the calibration parameters K1 and K2 are varied to obtain agreement between measured and calculated shoreline change over a known time interval as well as to produce realistic estimates of longshore sand transport rates. Initial estimates of some other parameters may also need to be altered.

391. In the course of calibration for Lakeview Park, usually only one parameter at a time was changed in order to isolate its effect and understand its role in the overall balance with other parameters. The strategy was to first determine values of main parameters controlling known quantities, in this case the net transport rate and volumetric change inside the study area. These parameter values were determined at the first stage of calibration, and parameters having mainly local and more minor influence were then used to optimize the calibration at the final stage.

392. For the present case, the value of the primary calibration parameter K1 was varied first until calculated overall net transport rates were close to the previously determined values. Second, the parameter K2

was varied alternately with the distance YG1 to obtain the approximate magnitude of net inflow of sand from the west. Third, the transmission coefficients of the breakwaters were adjusted to obtain the correct size of the salients behind the detached breakwaters. Fourth, the longshore location of the eastern detached breakwater was translated two grid cells to the east to obtain better agreement between calculated and measured positions of the easternmost salient. This small adjustment can be thought of as compensating for the finite grid size and oversimplification of the detached breakwaters as thin. Finally, the modelers "stepped back" from the calibration procedure and examined the results to see if there was a reasonable balance among the parameters and overall replication of the shoreline change and historic transport rates. The calibration result is shown in Figure 42, and the corresponding START and OUTPT files are given in Appendix D.

393. Figure 42 shows good agreement between the measured and calculated shoreline positions. The calculated CVE indicated that the mean absolute difference between the two shoreline positions was 4 ft. The calculated volumetric change was 4,400 cu yd compared with the measured 4,300 cu yd, again, a very good result.

394. If data are available, model predictions should be verified by reproducing measured shoreline change over a time interval independent of the calibration interval. Sensitivity testing should also be done with the calibrated model, with emphasis placed on sensitivity testing if verification data are not available. In the present case, shoreline position data were available for verification, but wave data over the interval between shoreline surveys were not. (Additional gage data are available for Lakeview Park and Cleveland which could be used to develop a more extensive wave data base, including examination of variability. Development of an expanded wave data set was beyond the scope of this illustrative case study, however.)

395. Verification was made for the 13-month interval between 9 October 1978 and 17 November 1979. As stated, only 1 year of wave data was available. It is doubtful that the same wave conditions that resulted in a net gain of 4,300 cu yd during the calibration period would likely produce a net loss of 300 cu yd for the verification period if all other conditions were left unchanged (although the shoreline shape and position did change).

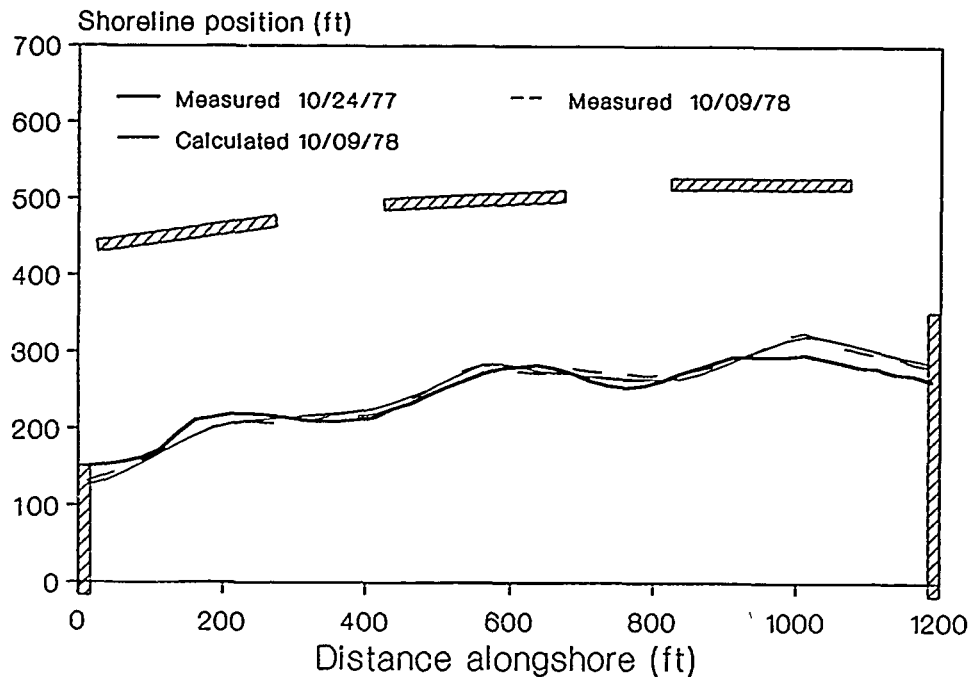

Figure 42. Result of model calibration

396. Aerial photographs indicated that the shoreline in the small pocket beach on the east side of the east groin had receded, almost doubling the distance from the shoreline to the seaward end of the groin between 1978 and 1979. Therefore, for the verification, YG1 was increased from 70 ft used in the calibration to 128 ft for the verification, as read from the photographs.

397. The model was then run for the verification period by using the 1-year wave field, and reasonable agreement was obtained between calculated and measured shoreline position. Subsequent sensitivity testing indicated that better results could be obtained if the wave height were increased by on the order of 10 percent. Therefore, the value HCNGF = 1.1 was entered on line B.1 in the START file. Other than changing YG1 and HCNGF, all other input values were the same as for the calibration. The verification result is shown in Figure 43. Similar to the case of the calibration, the measured and calculated shoreline positions for the verification are in good agreement.

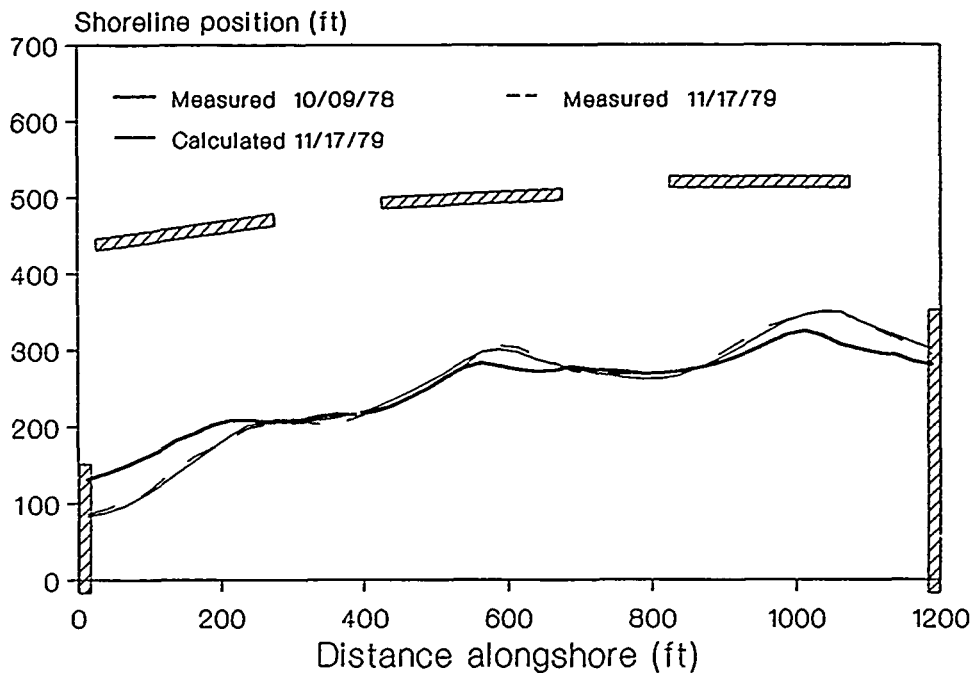

Figure 43. Result of model verification

The mean absolute difference between the two shorelines was 4 ft; calculated volumetric change was -311 cu yd compared with the measured -335 cu yd.

Sensitivity and Variability Tests

398. Prior to using a verified model for predicting shoreline change for alternative designs, the sensitivity of the calculated shoreline response to variations in different key input parameters in the START file should be examined in a systematic manner. (The identification of "key" input parameters will depend, in part, on the expected applications.) Although here only an analysis is made for selected parameters, the user is advised to undertake similar analyses with several parameters to gain understanding

between the change in the input (cause) and resultant change in the output (effect) for the specific project.

K1, K2, and median grain size

399. Figure 44 shows the results of sensitivity tests examining changes in the calibration parameters K1 and K2 and median grain size D50 . An increase in K1 from 0.42 to 0.52 resulted in a slight increase in sand volume inside the study area, but the shape of the shoreline was almost identical to that in the verification. An increase in K2 from 0.12 to 0.22 produced more pronounced salients, as expected, but slightly more sand was lost from the system than for the verification simulation. Both cases show that the simulated change was only moderately sensitive to reasonable changes in the calibration coefficients.

400. Almost all of the material lost was removed from the beach section adjacent to the western groin. The probable explanation for the localized loss of sand is the bias for the transport to be from west to east because of wave shadowing by Lorain Harbor; in other words, this is simply a downdrift-groin erosion phenomenon.

401. It is known that fill with a median diameter smaller than that of the native material requires larger initial quantities to create the same stable beach as a fill of larger diameter. However, the present structure configuration is very efficient in preventing the beach from eroding. The calculation using a median sand grain size 0.2 mm, half the diameter used in the actual project, shows very pronounced salients behind two of the breakwaters and gives a net increase of sand of about 780 cu yd as compared with the net loss of 340 cu yd by using the actual grain size 0.4 mm. The finer grain size produces a gentler equilibrium profile and places the breaker line farther offshore. However, the structures were not moved offshore to their depth of placement by changing the START file, making this example somewhat unrealistic.

402. It is important to note again that GENESIS does not take losses to the offshore into account, which are expected to be greater for finer material, and the model is expected to overestimate the performance of the finer fill material.

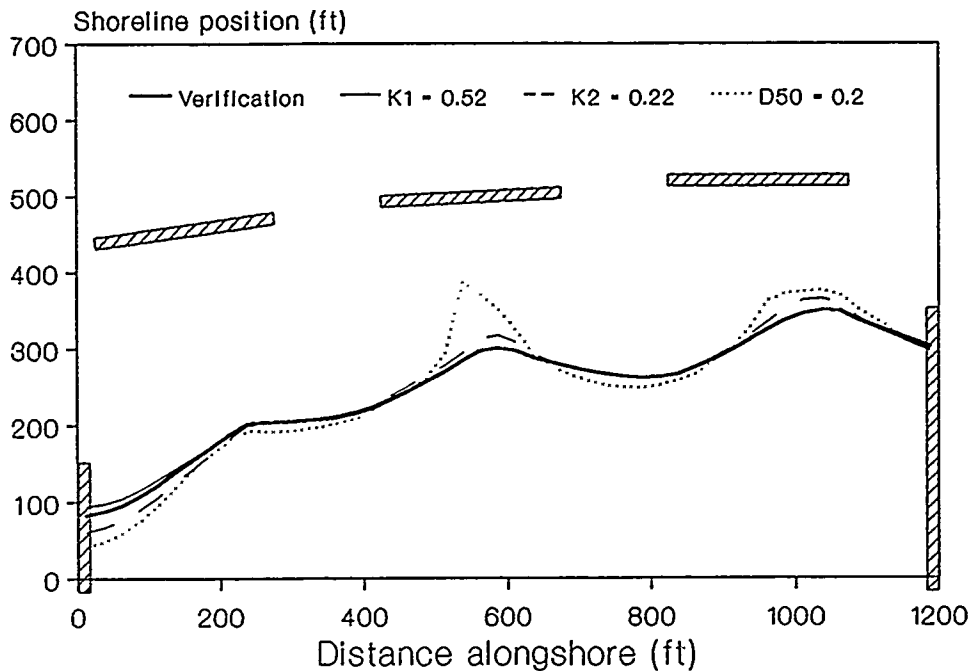

Figure 44. Model sensitivity to changes in K_1 , K_2 , and D_{50}

Wave transmission and offshore waves

403. Figure 45 illustrates model sensitivity to changes in the transmission of the breakwaters and to the offshore wave height and direction. The solid line represents a case where all three transmission coefficients were decreased by 0.2 resulting in K_T of 0.3, 0.02, and 0.1 as compared with the original values of 0.5, 0.22, and 0.3, respectively, from the west to east breakwater. The breakwaters were constructed at the same time and have the same cross sections. Therefore, the transmission coefficients should be equal. Simulations with a single value of K_T close to the average of those above also gave good results, but the calculated beach planform could be made to closely reproduce the measured planform by using unequal values. From the pragmatic perspective of obtaining the best calibration, differences in K_T values over the determined range were considered acceptable.

404. With the exception of the western part of the beach, smaller transmission coefficients result in larger salients without a corresponding

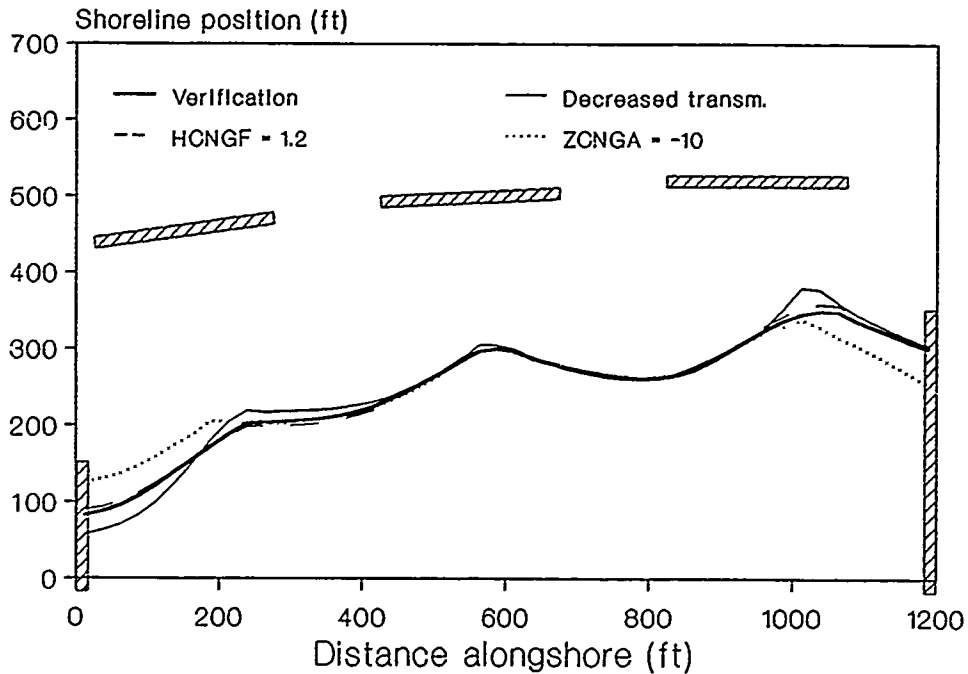

Figure 45. Model sensitivity to changes in K_T , HCNGF, and ZCNGA

increased recession of the shoreline behind the gaps between structures. As a whole, the decreased wave transmission simulation produced net accumulation in the area.

405. An increase in wave height of about 10 percent, produced by changing HCNGF from 1.1 used in the verification to 1.2, had almost the same effect as an increase of K_1 , i.e., a slight increase in volume contained by the project, but the calculated shoreline position shows very little departure from the verification result. Setting ZCNGA = -10 means that the offshore wave direction was uniformly shifted 10 deg to the east. The calculated result confirms the intuitive picture that erosion should decrease on the western side of the project and increase on the eastern side. Again, the calculated results indicate a moderate or low sensitivity of the model to changes in the input parameters.

Alternative Structure Configurations

406. After the modeling system had been calibrated, verified, and tested, it was possible to study alternative strategies for maintaining the beach fill in place. Walker, Clark, and Pope (1980) also discuss alternatives considered in arriving at the final choice of using detached breakwaters. Obvious alternatives are to remove the (expensive) detached breakwaters and/or groins in order to assess quantitatively the necessity for keeping them in place. This type of information might be useful if another project is to be constructed on a similar coast. An important limitation in this analysis is the absence of the probable mitigating effect of the breakwaters on offshore transport, which is not accounted for in GENESIS.

407. Shoreline change over the verification period 9 October 1978 to 17 November 1979 for three alternative configurations was investigated:

- a. Existing groins without detached breakwaters.
- b. Existing breakwaters without the terminal groins.
- c. Extended groins without detached breakwaters.

For case c, by trial and error the groins were extended to the length required to give the same volume change for the site as the existing (design) condition of detached breakwaters and shorter groins. Results of the simulations are shown in Figure 46. For the case with only the groins of existing length, the salients are absent, as was expected. More serious is the significant loss of 57,000 cu yd of fill, about half of the initial fill of 110,000 cu yd.

408. To simulate the case of removing the two groins, 20 cells were added on each side of the original calculation grid. The added shoreline/sea-wall positions were read from aerial photographs except for the farthest few cells, which were not covered by the photographs and were extrapolated by hand. Thus, the model contained 89 cells for this particular simulation. The value of NN on Line A.3 in the START file was set to 89, and the grid cell numbers of the detached breakwaters on Line G.6 were incremented by 20. As seen from Figure 46, the beach fill did very well on the updrift (west) side. In fact, slight accretion may be observed here since the west groin had been removed. Evidently this groin not only prevents sand from leaving the enclosed beach, but also prevents it from entering.

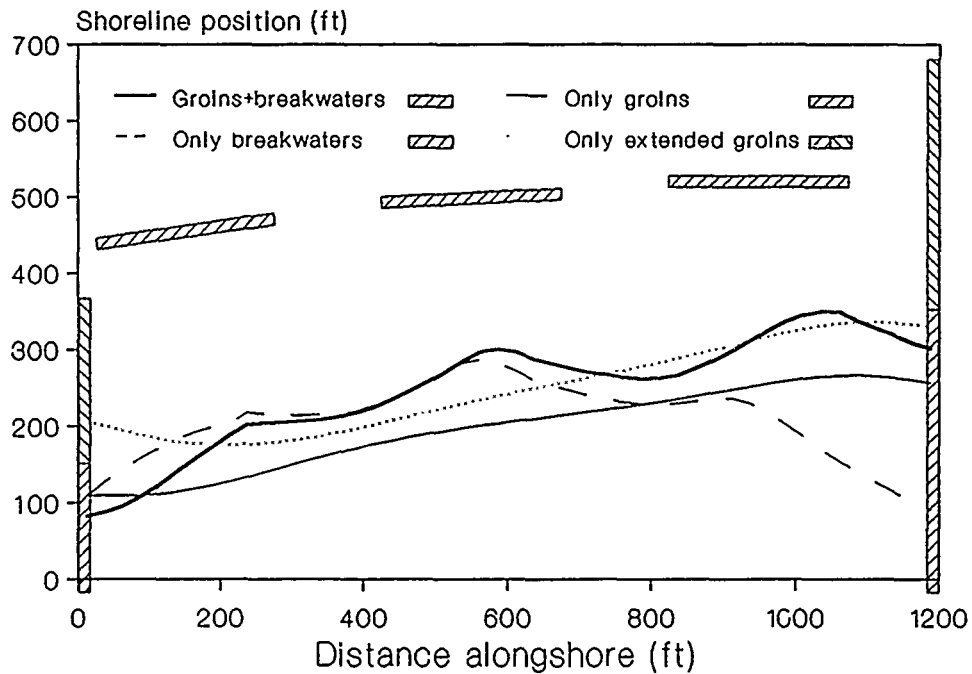

Figure 46. Shoreline change for alternative configurations

409. On the downdrift (east) end of the fill, the simulation indicated that the groin there is essential for retaining the beach. After removing the east groin, the shoreline receded about 210 ft at the eastern project boundary. At the same time, the whole area lost 50,000 cu yd, only slightly less than the amount lost in the alternative without breakwaters.

410. As the third hypothetical alternative, a simulation was made to investigate the length of the two terminal groins required to hold the beach in place to the same extent as the existing condition of combined groins and breakwaters. (Again, it is emphasized that cross-shore transport is not accounted for in this comparison; a tendency for fill to be transported offshore is considered to be a significant factor in the Great Lakes.) As indicated in Figure 46, the western groin had to be extended by 210 ft and the eastern groin by 320 ft to produce a net loss of sand of 285 cu yd (50 cu yd less than in the existing condition). Thus, according to the calculations and omitting consideration of cross-shore transport, it would be possible to build another 530 ft of groins rather than 750 ft of detached breakwaters to hold the beach fill in place. Since construction of groins is naturally shore-based, the groins are located in shallower water than the breakwaters over a

major portion of the structures, and less stone would be required, the groin extension alternative would be less expensive to build than the detached breakwater alternative. However, in the extended groin case, it is probable that offshore losses produced by steep waves and rip currents tending to form at groins would make the relative performance of the groins much inferior to detached breakwaters for containing the beach. The long groin alternative was rejected by the Corps of Engineers (USAED, Buffalo 1975) because of potential impacts on adjacent shores.

411. In conclusion, the simulations confirm that the combination of detached breakwaters and terminal groins is superior to simpler designs in holding the beach fill in place. Both the groin-only design and segmented detached breakwater-only design perform poorly, causing about half of the fill to be lost in 1 year, which is unacceptable.

Five-Year Simulation

412. It is interesting to perform a 5-year simulation with the calibrated model since shoreline position data are available for this period. Normally, such a long-term projection would be one of the objectives of a design study, whereas in the present case the simulation provides further verification of the model. In this illustrative case study, only a 1-year-long wave data file is available, precluding estimation of a likely range of predicted shoreline positions resulting from possible variations in the wave climate. Also, the time dependence of YG1, associated with the pocket beach to the west of the project, is unknown. The calibrated model was used with the distance YG1 = 90 ft to give the average annual fall trend of a net gain of 2,500 cu yd.

413. Figure 47 plots calculated annual net volume for the 5-year simulation extending from 24 October 1977 to 14 December 1982. The average net annual gain in volume was 2,400 cu yd, close to the trend in fall measurements of 2,500 cu yd. The measurements show a net gain of 3,300 cu yd for the second year, reduction to 2,500 cu yd in the third and fourth years, and a further reduction to 2,000 cu yd in the fifth year. The measurements show

consistent small gains in material that appear to be decreasing as the project slowly approaches a dynamic equilibrium.

414. Figure 48 is a plot of the calculated and measured shoreline in positions in December 1982. The calculation was begun in October 1977, and the 1-year wave data set was repeated. GENESIS predicted major shoreline change from 1977 through 1980 and only slight change thereafter, indicating that the project had adjusted to equilibrium with the 1-year data set.

415. Calculated and measured 1982 shorelines are in almost perfect agreement along the eastern two-thirds of the project, with the model reproducing the locations and shapes of the salients. It is also interesting to note that the model predicts the small shoreline recession observed within the distance of about 300 ft from the east groin. Erosion in the vicinity of the west groin is qualitatively reproduced, but the magnitude is less than the measured amount. Three reasons can be given for the underestimation:

- a. Inadequate wave time series.
- b. Wave diffraction by the groin, which was omitted in the model.
- c. Local effects, such as a rip current.

It is believed that the three reasons are important in the order they are given. In particular, the opening between the tip of the west groin and the western-most breakwater is relatively great, making the exposed area in that energy window more sensitive to variations in the wave climate than the protected areas in the shadow zone of the breakwaters. Additional sensitivity testing would easily shed light on whether the model prediction could be improved in the vicinity of the west groin without degrading the prediction elsewhere; this task is left as an exercise for the reader.

Summary and Discussion

416. The presented case study provides an example of data preparation, interpretation of previously obtained results, calibration and verification procedures, and, finally, use of the model to analyze alternative project designs. A description of many of the intermediate simulations had to be omitted, and it is emphasized that the treatment is somewhat schematic as compared with actual design applications.

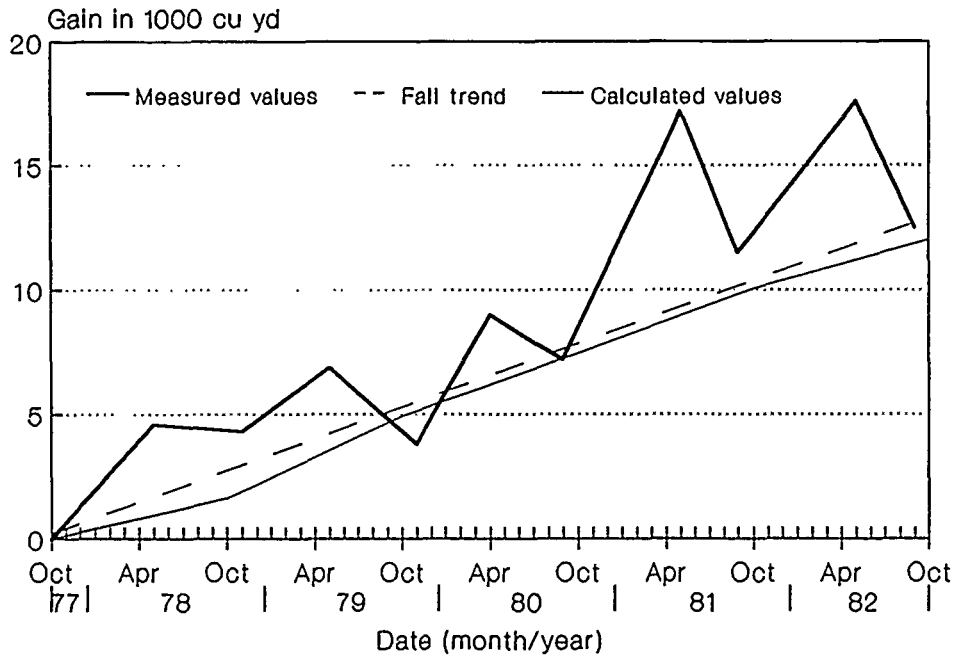

Figure 47. Volume change, October 1977-December 1982

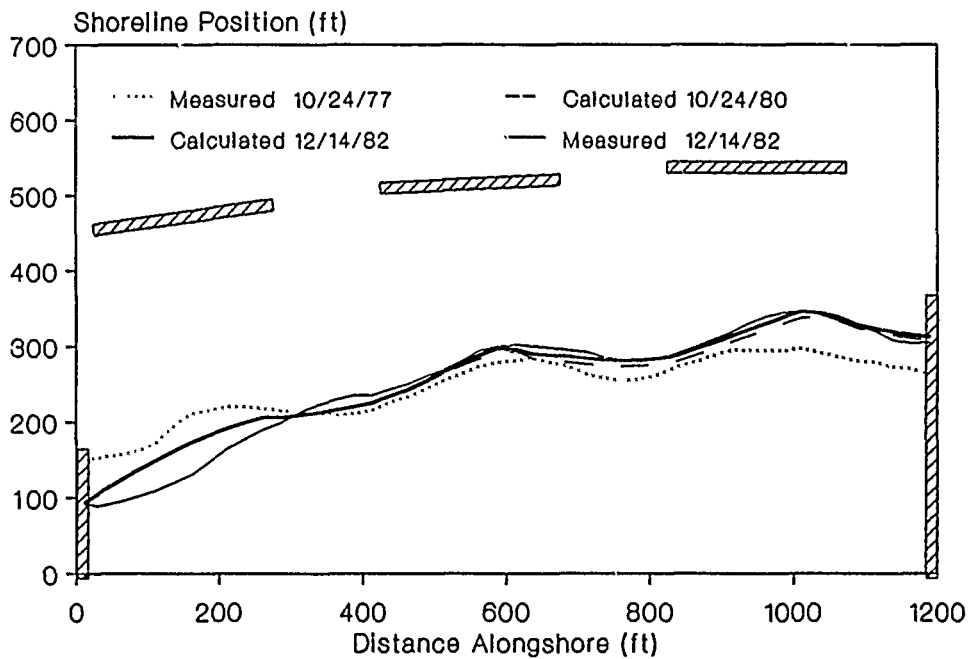

Figure 48. Shoreline change, October 1977-December 1982

417. It is recognized that every new application adds a new challenge to the art of shoreline simulation and that it is not possible to follow completely a set pattern or operating procedure. At the same time, however, modeling experience produces growth in this highly complex and integrated process, with each new application better preparing the modeler for the next. Therefore, the case study was presented with the dedication that it will point newcomers in the proper direction to analyze correctly other coastal protection problems.

418. The case study demonstrates that the modeling system GENESIS is highly effective for simulating the influence of waves and coastal structures on the long-term evolution of sandy beaches and that the system is capable of serving as an engineering tool for evaluating shore protection projects. The case study also emphasizes the importance of analyzing and understanding the input data and coastal processes in the region and at the project. Among the various factors entering a modeling project, all possible ingenuity and industry must be applied to develop correct input wave time series and boundary conditions. A lesson learned from the case study is the fragility of the modeling system to errors in the input data.

REFERENCES

- Bakker, W. T. 1968. "The Dynamics of a Coast with a Groyne System," Proceedings of the 11th Coastal Engineering Conference, American Society of Civil Engineers, pp 492-517.
- Bruun, P. 1954. "Coast Erosion and the Development of Beach Profiles," Technical Memorandum No. 44, Beach Erosion Board, US Army Corps of Engineers, Waterways Experiment Station, Vicksburg, MS.
- Chu, Y., Gravens, M. B., Smith, J. M., Gorman, L. T., and Chen, H. S. 1987. "Beach Erosion Control Study, Homer Spit, Alaska," Miscellaneous Paper CERC-87-15, US Army Engineer Waterways Experiment Station, Coastal Engineering Research Center, Vicksburg, MS.
- Crank, J. 1975. The Mathematics of Diffusion, 2nd ed., Clarendon Press, Oxford, England.
- Dally, W. R., and Pope, J. 1986. "Detached Breakwaters for Shore Protection," Technical Report CERC-86-1, US Army Engineer Waterways Experiment Station, Coastal Engineering Research Center, Vicksburg, MS.
- Dean, R. G. 1977. "Equilibrium Beach Profiles: US Atlantic and Gulf Coasts," Ocean Engineering Report No. 12, Department of Civil Engineering, University of Delaware, Newark, DE.
- Ebersole, B. A. 1985. "Refraction-Diffraction Model for Linear Water Waves," Journal of Waterway, Port, Coastal, and Ocean Engineering, Vol 111, No. WW6, pp 939-953.
- Ebersole, B. A., Gialone, M. A., and Prater, M. D. 1986. "RCPWAVE - A Linear Wave Propagation Model for Engineering Use," Technical Report CERC-86-4, US Army Engineer Waterways Experiment Station, Coastal Engineering Research Center, Vicksburg, MS.
- Goda, Y. 1984. Random Seas and Design of Maritime Structures, University of Tokyo Press, Tokyo, Japan.
- Goda, Y., Takayama, T., and Suzuki, Y. 1978. "Diffraction Diagrams for Directional Random Waves," Proceeding of 16th Coastal Engineering Conference, American Society of Civil Engineers, pp 628-650.
- Gravens, M. B. 1988. "Use of Hindcast Wave Data for Estimates of Longshore Sediment Transport," Proceedings Symposium on Coastal Water Resources, American Water Resources Association, pp 63-72.
- Gravens, M. B. "Comprehensive Shoreline Response Computer Simulation, Report 2: Bolsa Bay, California, Proposed Ocean Entrance System Study," Miscellaneous Paper in preparation, US Army Engineer Waterways Experiment Station, Coastal Engineering Research Center, Vicksburg, MS.

Gravens, M. B., and Kraus, N. C. 1989. "Representation of the Groin Boundary Condition in Numerical Shoreline Change Models," Proceedings XXIII Congress, International Association of Hydraulic Research, pp C515-C522.

Gravens, M. B., Scheffner, N. W., and Hubertz, J. M. 1989. "Coastal Processes from Asbury Park to Manasquan, New Jersey," Miscellaneous Paper CERC-89-11, US Army Engineer Waterways Experiment Station, Coastal Engineering Research Center, Vicksburg, MS.

Hallermeier, R. J. 1983. "Sand Transport Limits in Coastal Structure Design," Proceedings of Coastal Structures '83, American Society of Civil Engineers, pp 703-716.

Hanson, H. 1987. "GENESIS, A Generalized Shoreline Change Model for Engineering Use," Report No. 1007, Department of Water Resources Engineering, University of Lund, Lund, Sweden.

_____. 1989. "GENESIS - A Generalized Shoreline Change Numerical Model," Journal of Coastal Research, Vol 5, No. 1, pp 1-27.

Hanson, H., and Kraus, N. C. 1980. "Numerical Model for Studying Shoreline Change in the Vicinity of Coastal Structures," Report No. 3040, Department of Water Resources Engineering, University of Lund, Lund, Sweden.

_____. 1985. "Seawall Constraint in the Shoreline Numerical Model," Journal of Waterway, Port, Coastal and Ocean Engineering, Vol 111, No. 6, pp 1079-1083.

_____. 1986a. "Forecast of Shoreline Change Behind Multiple Coastal Structures," Coastal Engineering in Japan, Vol 29, pp 195-213.

_____. 1986b. "Seawall Boundary Condition in Numerical Models of Shoreline Evolution," Technical Report CERC-86-3, US Army Engineer Waterways Experiment Station, Coastal Engineering Research Center, Vicksburg, MS.

Hanson, H., and Larson, M. 1987. "Comparison of Analytic and Numerical Solutions of the One-Line Model of Shoreline Change," Proceedings of Coastal Sediments '87, American Society of Civil Engineers, pp 500-514.

Hanson, H., Kraus, N. C., Nakashima, L. D. 1989. "Shoreline Change Behind Transmissive Detached Breakwaters," Proceedings Coastal Zone '89, American Society of Civil Engineers, pp 568-582.

Horikawa, K., and Hattori, M. 1987. "The Nearshore Environment Research Center Project," Proceedings Coastal Sediments '87, American Society of Civil Engineers, pp 756-771.

Hunt, J. F. 1979. "Direct Solution of the Wave Dispersion Equation," Journal of Waterway, Port, Coastal, and Ocean Engineering, Vol 105, No. WW4, pp 457-459.

Jensen, R. E. 1983a. "Methodology for the Calculation of a Shallow-Water Wave Climate," Wave Information Study Report No. 8, US Army Engineer Waterways Experiment Station, Coastal Engineering Research Center, Vicksburg, MS.

_____. 1983b. "Atlantic Coast Hindcast, Shallow-Water Significant Wave Information," Wave Information Study Report No. 9, US Army Engineer Waterways Experiment Station, Coastal Engineering Research Center, Vicksburg, MS.

Jensen, R. E., Hubertz, J. M., and Payne, J. B. 1989. "Pacific Coast Hindcast Phase III North Wave Information," Wave Information Study Report No. 17, US Army Engineer Waterways Experiment Station, Coastal Engineering Research Center, Vicksburg, MS.

Komar, P. D. 1988. "Environmental Controls on Littoral Sand Transport," Proceedings of 21st Coastal Engineering Conference, American Society of Civil Engineers, pp 1238-1252.

Komar, P. D., and Inman, D. L. 1970. "Longshore Sand Transport on Beaches," Journal of Geophysical Research, Vol 73, No. 30, pp 5914-5927.

Kraus, N. C. 1981. "One-Line Development and Simulation for Oarai Beach," NERC Report No. 13, Cooperative Research of Surf Zone Dynamics, Part 3, Beaches Near Breakwaters and Rocky Coasts, Nearshore Environment Research Center, Tokyo, Japan, pp 155-192.

_____. 1982. "Pragmatic Calculation of the Breaking Wave Height and Wave Angle Behind Structures," Proceedings of 29th Japanese Coastal Engineering Conference, Japan Society of Civil Engineers, pp 295-299. (in Japanese)

_____. 1983. "Applications of a Shoreline Prediction Model," Proceedings of Coastal Structures '83, American Society of Civil Engineers, pp 632-645.

_____. 1984. "Estimate of Breaking Wave Height Behind Structures," Journal of Waterway, Port, Coastal and Ocean Engineering, Vol 110, No. 2, pp 276-282.

_____. 1988a. "Part IV: Prediction Models of Shoreline Change," Chapter 2, Wave Model, In: K. Horikawa, Ed., Nearshore Dynamics and Coastal Processes: Theory, Measurement, and Predictive Models, University of Tokyo Press, Tokyo, Japan, pp 324-328.

_____. 1988b. "Part IV: Prediction Models of Shoreline Change," Chapter 3, Shoreline Change Model, In: K. Horikawa, Ed., Nearshore Dynamics and Coastal Processes: Theory, Measurement, and Predictive Models, University of Tokyo Press, Tokyo, Japan, pp 329-336.

_____. 1988c. "Part IV: Prediction Models of Shoreline Change," Chapter 4, Numerical Calculation Method, In: K. Horikawa, Ed., Nearshore Dynamics and Coastal Processes: Theory, Measurement, and Predictive Models, University of Tokyo Press, Tokyo, Japan, pp 337-344.

Kraus, N. C. 1988d. "Part IV: Prediction Models of Shoreline Change," Chapter 6, Case Studies of Application of the Shoreline Change Model, In: K. Horikawa, Ed., Nearshore Dynamics and Coastal Processes: Theory, Measurement, and Predictive Models, University of Tokyo Press, Tokyo, Japan, pp 355-366.

_____. 1989. "Beach Change Modeling and the Coastal Planning Process," Proceedings Coastal Zone '89, American Society of Civil Engineers, pp 553-567.

Kraus, N. C., and Dean, J. L. 1987. "Longshore Sediment Transport Rate Distribution Measured by Trap," Proceedings of Coastal Sediments '87, American Society of Civil Engineers, pp 881-896.

Kraus, N. C., Gingerich, K. J., and Rosati, J. D. 1988. "Toward an Improved Empirical Formula for Longshore Sand Transport," Proceedings of 21st Coastal Engineering Conference, American Society of Civil Engineers, pp 1182-1196.

Kraus, N. C., Hanson, H., and Harikai, S. 1984. "Shoreline Change at Oarai Beach, Japan: Past, Present and Future," Proceedings of 19th Coastal Engineering Conference, American Society of Civil Engineers, pp 2107-2123.

Kraus, N. C., Hanson, H., and Larson, M. 1988. "Threshold for Longshore Sand Transport and Application to a Shoreline Change Simulation Model," Proceedings on Mathematical Modelling of Sediment Transport in the Coastal Zone, International Association of Hydraulic Research, pp 117-126.

Kraus, N. C., and Harikai, S. 1983. "Numerical Model of the Shoreline Change at Oarai Beach," Coastal Engineering, Vol 7, No. 1, pp 1-28.

Kraus, N. C., Harikai, S., and Kubota, S. 1981. "A Numerical Model of the Breaking Waves and Long-Term Shoreline Change at Oarai Beach," Proceedings of 28th Japanese Coastal Engineering Conference, Japan Society of Civil Engineers, pp 295-299. (in Japanese)

Kraus, N.C., Isobe, M., Igarashi, H., Sasaki, T., and Horikawa, K. 1982. "Field Experiments on Longshore Sand Transport in the Surf Zone," Proceedings of 18th Coastal Engineering Conference, American Society of Civil Engineers, pp 969-988.

Kraus, N. C., and Larson, M. 1988. "Prediction of Initial Profile Adjustment of Nourished Beaches to Wave Action," Proceedings Annual Conference on Shore and Beach Preservation Technology, Florida Shore and Beach Preservation Association, pp 125-137.

Kraus, N. C., Scheffner, N. W., Chou, L. W., Cialone, M. A., Smith, J. M., and Hardy, T. A. 1988. "Coastal Processes at Sea Bright to Ocean Township, New Jersey," Vol 1: Main Text and Appendix A, Miscellaneous Paper CERC-88-12, US Army Engineer Waterways Experiment Station, Coastal Engineering Research Center, Vicksburg, MS.

Kriebel, D. 1982. "Beach and Dune Response to Hurricanes," M.S. Thesis, Department of Civil Engineering, University of Delaware, Newark, DE.

Kriebel, D., and Dean, R. G. 1985. "Numerical Simulation of Time-Dependent Beach and Dune Erosion," Coastal Engineering, Vol 9, pp 221-245.

Larson, M. 1988. "Quantification of Beach Profile Change," Report No. 1008, Department of Water Resources Engineering, University of Lund, Lund, Sweden.

Larson, M., Hanson, H., and Kraus, N. C. 1987. "Analytical Solutions of the One-Line Model of Shoreline Change," Technical Report CERC-87-15, US Army Engineer Waterways Experiment Station, Coastal Engineering Research Center, Vicksburg, MS.

Larson, M., and Kraus, N. C. 1989a. "Prediction of Beach Fill Response to Varying Waves and Water Level," Proceedings Coastal Zone '89, American Society of Civil Engineers, pp 607-621.

_____. 1989b. "SBEACH: Numerical Model for Simulating Storm-Induced Beach Change," Report 1: Empirical Foundation and Model Development, Technical Report CERC-89-9, US Army Engineer Waterways Experiment Station, Vicksburg, MS.

Larson, M., Kraus, N. C., and Byrnes, M. R. "SBEACH: Numerical Model for Simulating Storm-Induced Beach Change, Report 2: Numerical Formulation and Model Tests," Technical Report in preparation, US Army Engineer Waterways Experiment Station, Coastal Engineering Research Center, Vicksburg, MS.

Larson, M., Kraus, N. C., and Hanson, H. "Schematized Numerical Model of Three-Dimensional Beach Change," Abstracts 22nd International Coastal Engineering Conference, in preparation, American Society of Civil Engineers.

Larson, M., Kraus, N. C., and Sunamura, T. 1988. "Beach Profile Change: Morphology, Transport Rate, and Numerical Simulation," Proceedings of 21st Coastal Engineering Conference, American Society of Civil Engineers, pp 1295-1309.

Leenknecht, D. A., and Szuwalski, A. Z. 1990. "Automated Coastal Engineering System: Technical Reference," US Army Engineer Waterways Experiment Station, Coastal Engineering Research Center, Vicksburg, MS.

Le Méhauté, B., Wang, J. D., and Lu, C. C. 1983. "Wave Discretization for Shore Line Processes," Journal of Waterway, Port, Coastal, and Ocean Engineering, Vol 109, No. WW1, pp 63-78

Mimura, N., Shimizu, T., and Horikawa, K. 1983. "Laboratory Study on the Influence of Detached Breakwater on Coastal Change," Proceedings of Coastal Structures '83, American Society of Civil Engineers, pp 740-752.

Mitchell, J. H. 1893. "On the Highest Waves in Water," Philosophic Magazine, Series 5, No. 36, pp 430-437.

Moore, B. 1982. "Beach Profile Evolution in Response to Changes in Water Level and Wave Height," M.S. Thesis, Department of Civil Engineering, University of Delaware, Newark, DE.

Ozasa, H., and Brampton, A. H. 1980. "Mathematical Modeling of Beaches Backed by Seawalls," Coastal Engineering, Vol 4, No. 1, pp 47-64.

Pelnard-Considere, R. 1956. "Essai de Theorie de l'Evolution des Forms de Rivage en Plage de Sable et de Galets," 4th Journees de l'Hydraulique, Les Energies de la Mer, Question III, No. 1, pp 289-298.

Perlin, M. 1979. "Predicting Beach Planforms in the Lee of a Breakwater," Proceedings Coastal Structures '79, American Society of Civil Engineers, pp 792-808.

Perlin, M., and Dean, R. G. 1978. "Prediction of Beach Planforms with Littoral Controls," Proceedings of 16th Coastal Engineering Conference, American Society of Civil Engineers, pp 1818-1838.

Pope, J., and Rowen, D. D. 1983. "Breakwaters for Beach Protection at Lorain, OH," Proceedings of Coastal Structures '83, American Society of Civil Engineers, pp 753-768.

Saville, T. 1953. "Wave and Water Level Statistics for Lake Erie," Technical Memorandum No. 37, Beach Erosion Board, US Army Corps of Engineers.

Shore Protection Manual. 1984. 4th ed., 2 Vols, US Army Engineer Waterways Experiment Station, Coastal Engineering Research Center, US Government Printing Office, Washington, DC.

Smith, E. R., and Kraus, N. C. "Laboratory Study of Macrofeatures of Wave Breaking Over Bars and Reefs," Technical Report in preparation, US Army Engineer Waterways Experiment Station, Coastal Engineering Research Center, Vicksburg, MS.

Tanaka, N. 1988. "Part IV: Prediction Models of Shoreline Change," Chapter 5, Establishment of Simulation Conditions," In: K. Horikawa, Ed., Nearshore Dynamics and Coastal Processes: Theory, Measurement, and Predictive Models, University of Tokyo Press, Tokyo, Japan, pp 345-354.

US Army Engineer District, Buffalo. 1975. "Cooperative Beach Erosion Control Project for lakeview Park, Lorain, Ohio," General Design Memorandum, Phase II, Project Design, Buffalo, NY.

Vemulakonda, S. R., Scheffner, N. W., Earickson, J. A., and Chou, L. W. 1988. "Kings Bay Coastal Processes Numerical Model," Technical Report CERC-88-3, US Army Engineer Waterways Experiment Station, Coastal Engineering Research Center, Vicksburg, MS.

Walker, J. R., Clark, D., and Pope, J. 1980. "A Detached Breakwater System for Beach Protection," Proceedings 17th Coastal Engineering Conference, American Society of Civil Engineers, pp 1968-1987.

Walton, T. L., Liu, P. L.-F., and Hands, E. B. 1988. "Shoreline at Jetty Due to Cyclic and Random Waves," Proceedings of 21st Coastal Engineering Conference, American Society of Civil Engineers, pp 1911-1921.

Watanabe, A. 1988. "Part III: Numerical Model of Beach Topography Change," Chapter 5, In: K. Horikawa, Ed., Nearshore Dynamics and Coastal Processes: Theory, Measurement, and Predictive Models, University of Tokyo Press, Tokyo, Japan, pp 303-318.

APPENDIX A: REVIEW OF RELATED GENESIS STUDIES

1. This appendix provides a short review of selected publications related to the Generalized Model for Simulating Shoreline Change (GENESIS) and antecedent models. These works may be consulted for details on calculation procedures, results of sensitivity tests, and hints on application of the modeling system in applications. Specifications and recommendations given in the present manual may differ from those in previous publications; the present and future reports in the Coastal Engineering Research Center (CERC), US Army Engineer Waterways Experiment Station, GENESIS series should be considered as representing capabilities of the current modeling system and the procedure for its operation.

2. In the following paragraphs, references are listed in chronological order, and key points of the study are described.

3. Kraus and Harikai (1983)*: This study introduces many of the basic calculation algorithms used in GENESIS. The site for the field application, Oarai Beach, Japan, provided an ideal environment for model testing and refinement since a complete data base of wave measurements, shoreline change, and other information was available. Sensitivity of the model to the input wave data and its variability are examined, with emphasis on the length of the time step and the averaging interval for wave data. A 6-hr time step is recommended as standard for the coast for design studies. The longshore variation in breaking wave height as produced by diffraction at a long breakwater was measured, and the data used to verify the calculation procedure for combined wave diffraction, refraction, shoaling, and breaking. Other topics addressed are determination of the depth of closure, longshore sand transport rate formula combining the effects of oblique wave incidence and longshore gradient in wave height, use of a line source term for cross-shore transport, verification of the bottom contour modification for the wave calculation using field measurements of breaking wave angle influenced by diffraction, and calibration and verification with measured wave and shoreline change data. Previous work on the antecedent model is contained in a report

* See References at the end of the main text.

(Kraus 1981) and an article written in Japanese (Kraus, Harikai, and Kubota 1981). A comprehensive summary of the model is given in Kraus (1988a-d).

4. Kraus (1983): This paper describes a verification of calculated breaking wave height, breaking wave angle, and resultant shoreline change using quantities measured in a physical model experiment of shoreline change produced by a detached breakwater. The numerical model well reproduced the time rate of shoreline change observed in the physical model, i.e., rapid change at the initial stage of wave action followed by slower change in approach to an equilibrium planform shape. Details of the breaking wave calculation are described in an article in Japanese (Kraus 1982) and a technical note (Kraus 1984).

5. Kraus, Hanson, and Harikai (1984): This article extends the material in the paper of Kraus and Harikai (1983) to include the addition of a massive detached breakwater, resulting in a model containing three sources of diffraction, and a jetty, a groin, and a seawall. Other topics addressed are qualitative correlation of measured frequencies of breaking wave height alongshore and direction of the longshore current to the observed long-term shoreline change, methods to produce wave time series for prediction and simple estimates of bounds of expected variability in the wave data, sensitivity of model results on changes in wave data.

6. Hanson and Kraus (1986a): This is the third and concluding article in the series (Kraus and Harikai 1983; Kraus, Hanson, and Harikai 1984) on shoreline change modeling and model development using the Oarai Beach data set. The article focuses on evaluation of shore-protection alternatives with the shoreline change model. Sensitivity of shoreline change to wave variability is examined in detail. It is found that shoreline change controlled by wave diffraction is relatively insensitive to the sequence of wave input and offshore wave direction, as opposed to the case of shoreline change on an open coast (Le Méhauté, Wang, and Lu 1983). Alternative shore-protection plans evaluated included a detached breakwater, beach nourishment, a groin field, and combinations of these basic solution elements.

7. Hanson and Kraus (1986b): This report documents a rigorous implementation of a seawall within the framework of shoreline modeling theory and includes discussion of assumptions, numerical formulation, example calcula-

tions, and computer programs for both explicit and implicit numerical solution schemes.

8. Hanson (1987): This report, a doctoral dissertation, documents the first version of the GENESIS modeling system. The concepts of longshore calculation domains and wave energy windows are introduced, and major previous and newly developed algorithms comprising GENESIS are described, including multiple diffraction, sand bypassing and permeability of groins, and representation of beach fill. Results of numerous model sensitivity tests are discussed and several case studies presented.

9. Kraus et al. (1988): This report describes a circa 1985 application of GENESIS to the north New Jersey shore. The 8-mile-long reach contained 93 groins and involved development of strategies to deal with long simulation times and long coastal reaches, as well as numerous refinements to GENESIS to overcome many practical problems encountered with input of wave information from an external wave transformation model and reliability of the internal wave calculation under complex shoreline configurations. An arbitrary threshold for longshore transport was set at a wave height of 20 cm to reduce calculation time. The practical strategy of keying nearshore wave refraction calculation results to a limited number of wave period-angle bands for unit deepwater wave height was developed in this study.

10. Chu et al. (1987): This report describes the evaluation of several shore-protection alternatives for a beach with a large tidal range and composite grain size material.

11. Hanson and Larson (1987): This article gives comparisons of analytical solutions as described in Larson, Hanson, and Kraus (1987) and numerical predictions of GENESIS.

12. Kraus, Hanson, and Larson (1988): This article describes development of an objective empirical criterion for predicting a threshold of effective longshore sand transport rate. Comparisons of calculated shoreline change with and without the threshold are made and results interpreted through the general characteristics of the input wave time series.

13. Hanson (1989): This article presents an overview of the first version of GENESIS, succinctly describing numerous technical and practical

features of the modeling system and presenting results of several sensitivity tests and applications.

14. Gravens and Kraus (1989): Two different methods of representing the effect of groins on the longshore sand transport rate are investigated.

15. Hanson, Kraus, and Nakashima (1989): This article presents results of sensitivity tests on the procedure for calculating wave transmission at detached breakwaters and the resultant shoreline change. The procedure is verified using data from Holly Beach, Louisiana, the site of six detached breakwaters of different materials and wave transmission characteristics. Good agreement is found between calculated and measured shoreline position, validating the calculation procedure and importance of wave transmission in controlling shoreline change.

16. Gravens, Scheffner, and Hubertz (1989): This report describes an application of GENESIS for the 9-mile reach of Atlantic coast between Asbury Park and Manasquan, New Jersey. The modeled reach included jetties at two inlets and 44 groins. A methodology to incorporate wave shadowing by Long Island on the project shoreline was developed and implemented through use of a nearshore wave transformation model. A procedure for selection of a representative 3-year time history of wave conditions from a 20-year hindcast data base is presented. The potential impact of excavation of three nearshore beach-fill borrow sites on shoreline change was investigated, and the concept of a verification variability range introduced. The performance of six proposed and four revised project design alternatives was evaluated over a 10-year simulation period using GENESIS to predict the planform evolution of the beach.

17. Gravens (in preparation): This report describes an application of GENESIS to estimate the potential impacts on adjacent shorelines resulting from the construction of a new ocean inlet system between Anaheim Bay and the Santa Ana River in southern California. In this study three simultaneous independent wave sources (Northern Hemisphere swell, Southern Hemisphere swell, and locally generated wind sea) were used to drive the shoreline change model. In addition to estimating potential shoreline impacts, three project mitigation design alternatives were quantitatively investigated.

APPENDIX B: BLANK INPUT FILES

This appendix gives blank copies of input files used to operate the Generalized Model for Simulating Shoreline Change (GENESIS) Version 2.

START

* INPUT FILE START.DAT TO GENESIS VERSION 2.0 *

A----- MODEL SETUP -----A
A.1 RUN TITLE

A.2 INPUT UNITS (METERS=1; FEET=2): ICONV

A.3 TOTAL NUMBER OF CALCULATION CELLS AND CELL LENGTH: NN, DX

A.4 GRID CELL NUMBER WHERE SIMULATION STARTS AND NUMBER OF CALCULATION CELLS (N = -1 MEANS N = NN): ISSTART, N

A.5 VALUE OF TIME STEP IN HOURS: DT

A.6 DATE WHEN SHORELINE SIMULATION STARTS
(DATE FORMAT YYYYMMDD: 1 MAY 1992 = 920501): SIMDATS

A.7 DATE WHEN SHORELINE SIMULATION ENDS OR TOTAL NUMBER OF TIME STEPS
(DATE FORMAT YYYYMMDD: 1 MAY 1992 = 920501): SIMDATE

A.8 NUMBER OF INTERMEDIATE PRINT-OUTS WANTED: NOUT

A.9 DATES OR TIME STEPS OF INTERMEDIATE PRINT-OUTS
(DATE FORMAT YYYYMMDD: 1 MAY 1992 = 920501, NOUT VALUES): TOUT(I)

A.10 NUMBER OF CALCULATION CELLS IN OFFSHORE CONTOUR SMOOTHING WINDOW
(ISMOOTH = 0 MEANS NO SMOOTHING, ISMOOTH = N MEANS STRAIGHT LINE.
RECOMMENDED DEFAULT VALUE = 11): ISMOOTH

A.11 REPEATED WARNING MESSAGES (YES=1; NO=0): IRWM

A.12 LONGSHORE SAND TRANSPORT CALIBRATION COEFFICIENTS: K1, K2

A.13 PRINT-OUT OF TIME STEP NUMBERS? (YES=1, NO=0): IPRINT

B----- WAVES -----B

B.1 WAVE HEIGHT CHANGE FACTOR. WAVE ANGLE CHANGE FACTOR AND AMOUNT (DEG)
(NO CHANGE: HCNGF=1, ZCNGF=1, ZCNGA=0): HCNGF, ZCNGF, ZCNGA

Figure B1. START file template (Sheet 1 of 4)

B.2 DEPTH OF OFFSHORE WAVE INPUT: DZ

B.3 IS AN EXTERNAL WAVE MODEL BEING USED (YES=1; NO=0): NWD

B.4 COMMENT: IF AN EXTERNAL WAVE MODEL IS NOT BEING USED, CONTINUE TO B.6

B.5 NUMBER OF SHORELINE CALCULATION CELLS PER WAVE MODEL ELEMENT: ISPW

B.6 VALUE OF TIME STEP IN WAVE DATA FILE IN HOURS (MUST BE AN EVEN MULTIPLE OF, OR EQUAL TO DT): DTW

B.7 NUMBER OF WAVE COMPONENTS PER TIME STEP: NWAVES

B.8 DATE WHEN WAVE FILE STARTS (FORMAT YYMMDD: 1 MAY 1992 = 920501): WDATS

C----- BEACH -----C

C.1 EFFECTIVE GRAIN SIZE DIAMETER IN MILLIMETERS: D50

C.2 AVERAGE BERM HEIGHT FROM MEAN WATER LEVEL: ABH

C.3 CLOSURE DEPTH: DCLOS

D----- NONDIFFRACTING GROINS -----D

D.1 ANY NONDIFFRACTING GROINS? (NO=0, YES=1): INDG

D.2 COMMENT: IF NO NONDIFFRACTING GROINS, CONTINUE TO E.

D.3 NUMBER OF NONDIFFRACTING GROINS: NNDG

D.4 GRID CELL NUMBERS OF NONDIFFRACTING GROINS (NNDG VALUES): IXNDG(I)

D.5 LENGTHS OF NONDIFFRACTING GROINS FROM X-AXIS (NNDG VALUES): YNDG(I)

E----- DIFFRACTING (LONG) GROINS AND JETTIES -----E

E.1 ANY DIFFRACTING GROINS OR JETTIES? (NO=0, YES=1): IDG

E.2 COMMENT: IF NO DIFFRACTING GROINS, CONTINUE TO F.

E.3 NUMBER OF DIFFRACTING GROINS/JETTIES: NDG

E.4 GRID CELL NUMBERS OF DIFFRACTING GROINS/JETTIES (NDG VALUES): IXDG(I)

E.5 LENGTHS OF DIFFRACTING GROINS/JETTIES FROM X-AXIS (NDG VALUES): YDG(I)

E.6 DEPTHS AT SEAWARD END OF DIFFRACTING GROINS/JETTIES(NDG VALUES): DDG(I)

F----- ALL GROINS/JETTIES -----F

F.1 COMMENT: IF NO GROINS OR JETTIES, CONTINUE TO G.

F.2 REPRESENTATIVE BOTTOM SLOPE NEAR GROINS: SLOPE2

F.3 PERMEABILITIES OF ALL GROINS AND JETTIES (NNDG+NDG VALUES): PERM(I)

Figure B1. (Sheet 2 of 4)

- F.4 IF GROIN OR JETTY ON LEFT-HAND BOUNDARY, DISTANCE FROM SHORELINE
OUTSIDE GRID TO SEAWARD END OF GROIN OR JETTY: YG1
- F.5 IF GROIN OR JETTY ON RIGHT-HAND BOUNDARY, DISTANCE FROM SHORELINE
OUTSIDE GRID TO SEAWARD END OF GROIN OR JETTY: YGN
- G----- DETACHED BREAKWATERS -----G
- G.1 ANY DETACHED BREAKWATERS? (NO=0, YES=1): IDB
- G.2 COMMENT: IF NO DETACHED BREAKWATERS, CONTINUE TO H.
- G.3 NUMBER OF DETACHED BREAKWATERS: NDB
- G.4 ANY DETACHED BREAKWATER ACROSS LEFT-HAND CALCULATION BOUNDARY
(NO=0, YES=1): IDB1
- G.5 ANY DETACHED BREAKWATER ACROSS RIGHT-HAND CALCULATION BOUNDARY
(NO=0, YES=1): IDBN
- G.6 GRID CELL NUMBERS OF TIPS OF DETACHED BREAKWATERS
(2 * NDB - (IDB1+IDBN) VALUES): IXDB(I)
- G.7 DISTANCES FROM X-AXIS TO TIPS OF DETACHED BREAKWATERS
(1 VALUE FOR EACH TIP SPECIFIED IN G.6): YDB(I)
- G.8 DEPTHS AT DETACHED BREAKWATER TIPS (1 VALUE FOR EACH TIP
SPECIFIED IN G.6): DDB(I)
- G.9 DETACHED BREAKWATER TRANSMISSION COEFFICIENTS (NDB VALUES): TRANDB(I)
- H----- SEAWALLS -----H
- H.1 ANY SEAWALL ALONG THE SIMULATED SHORELINE? (YES=1; NO=0): ISW
- H.2 COMMENT: IF NO SEAWALL, CONTINUE TO I.
- H.3 GRID CELL NUMBERS OF START AND END OF SEAWALL (ISWEND = -1 MEANS
ISWEND = N): ISWBEG, ISWEND
- I----- BEACH FILLS -----I
- I.1 ANY BEACH FILLS DURING SIMULATION PERIOD? (NO=0, YES=1): IBF
- I.2 COMMENT: IF NO BEACH FILLS, CONTINUE TO K.
- I.3 NUMBER OF BEACH FILLS DURING SIMULATION PERIOD: NBF
- I.4 DATES OR TIME STEPS WHEN THE RESPECTIVE FILLS START
(DATE FORMAT YYMMDD: 1 MAY 1992 = 920501, NBF VALUES): BFDATS(I)
- I.5 DATES OR TIME STEPS WHEN THE RESPECTIVE FILLS END
(DATE FORMAT YYMMDD: 1 MAY 1992 = 920501, NBF VALUES): BFDATE(I)
- I.6 GRID CELL NUMBERS OF START OF RESPECTIVE FILLS (NBF VALUES): IBFS(I)

Figure B1. (Sheet 3 of 4)

I.7 GRID CELL NUMBERS OF END OF RESPECTIVE FILLS (NBF VALUES): IBFE(I)

I.8 ADDED BERM WIDTHS AFTER ADJUSTMENT TO EQUILIBRIUM CONDITIONS (NBF VALUES): YADD(I)

K----- COMMENTS -----K
* COMMENTS AND VERSION UPDATE INFORMATION PLACED HERE
* ADVERTISING RATES AVAILABLE
----- END OF START.DAT -----

Figure B1. START file template (Sheet 4 of 4)

SHORL

SHORELINE LOCATION MEASURED AT:

DATE:

DX:

.....
.....
.....
.....
.....
.....
.....
.....
.....
.....
.....
.....
.....

Figure B2. SHORL file template

WAVES

WAVES MEASURED AT: DATE:
FILE CONTAINS ONLY OFFSHORE WAVE DATA. DT: DX:
***** ***** ***** ***** ***** ***** ***** ***** ***** *****

.....
.....
.....
.....
.....

WAVES MEASURED AT: DATE:
FILE CONTAINS OFFSHORE AND NEARSHORE WAVE DATA. DT: DX:
***** ***** ***** ***** ***** ***** ***** ***** ***** *****

.....
.....
.....
.....
.....
.....
.....
.....
.....
.....
.....
.....
.....
.....

Figure B5. WAVES file template

APPENDIX C: ERROR AND WARNING MESSAGES AND RECOVERY PROCEDURES

1. This appendix contains a list of error and warning messages that are presently incorporated in the Generalized Model for Simulating Shoreline Change (GENESIS). The error-trapping capability of new versions of GENESIS is expected to be an active area of improvement in the modeling system, and an expanded list of enhancements will be provided with new versions. As described in the main text of this report, error messages indicate a condition that will stop operation of the modeling system, whereas warning messages indicate a potentially undesirable condition, but the calculation is allowed to proceed.

2. Messages are given in alphabetical order in bold capital letters, followed by an explanation and suggested error-recovery procedure. The material is repetitive to allow the user to read without cross-reference.

Error Messages

3. **ERROR. BAD BALANCE IN WAVE INPUT PARAMETERS CAUSING DLTZ TO BE NEGATIVE.** The depth of longshore sand transport (DLTZ is called "D_{LTo}" in the main text) is proportional to the wave height with a correction for the wave steepness. For actually occurring waves, this correction term is small, but in situations for which the modeler fabricates a wave climate, the correction term can inadvertently become unphysically large. This error message will appear if the depth of longshore sand transport becomes negative and is remedied by changing the wave height and/or period in the WAVES file to represent physically reasonable waves.

4. **ERROR. BEACH FILL IS OUTSIDE CALCULATION GRID.** GENESIS has the option of performing simulations over a portion of the beach through specification of grid cell numbers other than 1 and N+1 where the simulation starts and ends. These numbers are entered on Line A.4 in the START file. To facilitate use of the model, the coordinates of beach fills, as specified on Lines I.6 and I.7, and structures are always given in the total coordinate system. In this way the modeler does not have to change the coordinates of operations as he or she targets one portion of the beach or another to be

modeled. The user must input only the part of the beach fill that appears inside the portion of the beach presently being modeled. GENESIS transforms the coordinates from the total coordinate system covering the whole beach to the local system covering only the portion of beach. This error will appear if the recalculated grid cell numbers fall outside the range of the local grid. If the entire fill lies outside the grid, the error is remedied by omitting corresponding values on Lines I.4-I.8. If the fill is only partially outside the grid, the error is remedied by setting IBFS on Line I.6 equal to the grid cell number where the simulation starts, if the right side of the beach fill is outside the grid, or by setting IBFE equal to the grid cell number where the simulation ends, if the left side of the seawall is outside the grid.

5. ERROR. BOTH SEMI-INFINITE DETACHED BREAKWATER AND A DIFFRACTING GROIN ON LEFT-HAND BOUNDARY NOT ALLOWED. Although GENESIS permits almost arbitrary placement of structures, there are restrictions. One basic restriction is that diffracting structures may not overlap. This means, for example, that it is not possible to place a diffracting groin between two tips of a detached breakwater. This error will appear if a detached breakwater is specified on Line G.4 in the START file to cross the left-hand boundary and if at the same time a diffracting groin is located in cell number 1 on Line E.4 in the START file. This error is remedied by any of three alternatives:

- a. Replace the diffracting groin with a nondiffracting groin.
- b. Extend the diffracting groin to the detached breakwater, specify that the detached breakwater does not cross the left-hand boundary by setting IDB1 = 0 on Line G.4 in the START file, and at the same time specify that the detached breakwater starts in cell number 1 on Line G.6 in the START file.
- c. Move the diffracting groin so that it will no longer be inside the detached breakwater, which means that IXDG(1) on Line E.4 in the START file must be greater than or equal to IXDB(1) on Line G.6.

6. ERROR. BOTH SEMI-INFINITE DETACHED BREAKWATER AND A DIFFRACTING GROIN ON RIGHT-HAND BOUNDARY NOT ALLOWED. Although GENESIS permits almost arbitrary placement of structures, there are restrictions. One basic restriction is that diffracting structures may not overlap. This means, for example, that it is not possible to place a diffracting groin between the two tips of a detached breakwater. This error will appear if a detached breakwater is

specified on Line G.5 in the START file to cross the right-hand boundary and if, at the same time, a diffracting groin is located in cell number N+1 on Line E.4 in the START file. The error is remedied in three ways:

- a. Replace the diffracting groin with a nondiffracting groin.
- b. Extend the diffracting groin to the detached breakwater, specify that the detached breakwater does not cross the left-hand boundary by setting IDBN = 0 on Line G.5 in the START file, and at the same time specify that the detached breakwater ends in cell number N+1 on Line G.6 in the START file.
- c. Move the diffracting groin so that it will no longer be inside the detached breakwater, which means that IXDG(NDG) (last diffracting groin) on Line E.4 in the START file must be smaller than or equal to IXDB(NDBTP) (last detached breakwater tip) on Line G.6.

7. ERROR. DETACHED BREAKWATER CAN ONLY CONNECT TO A GROIN AT THE GROIN TIP. Two of the basic structural elements in GENESIS, the jetty and the detached breakwater, may be combined to produce complex configurations, e.g., spur jetties. However, one requirement is that the structures attach only at tips. This error will appear if a detached breakwater is connected to a diffracting groin other than at its tip and is remedied by moving the detached breakwater tip to the end of the groin or by moving either of the two structures to separate them.

8. ERROR. DETACHED BREAKWATER ENDING ON OPEN LEFT-HAND BOUNDARY NOT ALLOWED. Although GENESIS permits almost arbitrary placement of structures, there are restrictions. One basic restriction is that a detached breakwater cannot end on a grid boundary. Such placement implies that the first (or last) energy window is outside the calculation grid and that wave energy entering through it could not be determined. This message will appear if a breakwater tip is in cell number 1 on Line G.6 in the START file and is remedied by either considering the detached breakwater as being semi-infinite by setting IDB1 = 1 on Line G.4 in the START file or by specifying the first cell number to be 2 or higher, as given on Line G.6 and setting IDB1 = 0 on Line G.4 in the START file.

9. ERROR. DETACHED BREAKWATER ENDING ON OPEN RIGHT-HAND BOUNDARY NOT ALLOWED. Although GENESIS permits almost arbitrary placement of structures, there are restrictions. One basic restriction is that a detached breakwater cannot end on the grid boundary. Such placement implies that the first (or

last) energy window would fall entirely outside the calculation grid and that wave energy entering through it could not be determined. This error will appear if a breakwater tip is specified in cell number $N+1$ on Line G.6 in the START file and is remedied by either considering the detached breakwater as being semi-infinite by setting $IDBN = 1$ on Line G.5 in the START file or by specifying the last cell number to be N or less as given on Line G.6 and setting $IDB1 = 0$ on Line G.4 in the START file.

10. ERROR. DETACHED BREAKWATER TIP OUTSIDE CALCULATION GRID. GENESIS has the option of performing simulations over a portion of the beach through specification of grid cell numbers other than 1 and $N+1$ where the simulation starts and ends. These numbers are entered on Line A.4 in the START file. To facilitate use of the model, the coordinates of diffracting groins, as entered on Line E.4, and other structures are given in the total coordinate system. In this way the modeler does not have to change the coordinates of the structures as he or she targets one portion of the beach or another for modeling. However, only those structures that appear inside the portion of the beach presently being modeled should be specified. GENESIS transforms the coordinates from the total coordinate system to the local system covering a portion of the beach. This error is remedied by removing these grid cell numbers from Line G.6 and the corresponding distances from x-axis and depths on Lines G.7 and G.8, respectively. If the entire detached breakwater is outside the grid, the corresponding transmission coefficient as specified on Line G.9 must also be removed.

11. ERROR. DIFFRACTING GROIN OUTSIDE CALCULATION GRID. GENESIS has the option of performing simulations over a portion of the beach through specification of grid cell numbers other than 1 and $N+1$ where the simulation starts and ends. These numbers are entered on Line A.4 in the START file. To facilitate use of the model, the coordinates of diffracting groins, as entered on Line E.4, and other structures are given in the total coordinate system. In this way the modeler does not have to change the coordinates of the structures as he or she targets one portion of the beach or another for modeling. However, only those structures that appear inside the portion of the beach being modeled should be specified. GENESIS transforms the coordinates from the total coordinate system to the local system covering a

portion of the beach. This error is remedied by omitting these grid cell numbers from Line E.4 and the corresponding lengths and depths on Lines E.5 and E.6, respectively.

12. ERROR. DIFFRACTING STRUCTURES OVERLAP. Although GENESIS permits almost arbitrary placement of structures, there are restrictions. One basic restriction is that diffracting structures may not overlap. This means, for example, that it is not possible to place a diffracting groin between the two tips of a detached breakwater. This error will appear if a diffracting groin is specified on Line E.4 in the START file to be located in a cell between the two tips of a detached breakwater as specified on Line G.6. The error is remedied by any of three alternatives:

- a. Replace the diffracting groin with a nondiffracting groin.
- b. Extend the diffracting groin to attach to the detached breakwater and at the same time divide the detached breakwater into two detached breakwaters, specified on Lines G.3 and G.6-G.8, each attaching to the tip of the groin, together constituting a T-groin.
- c. Move the diffracting groin so that it will no longer be inside the detached breakwater as specified on Lines E.4 and G.6 in the START file.

13. ERROR. END X-COORDINATE OF SEAWALL MUST BE GREATER THAN THE START X-COORDINATE. In accordance with the seawall boundary condition, the calculated shoreline location is compared with the corresponding seawall location in each cell within the extent of the seawall from cell number ISWBEG to cell number ISWEND, as specified on Line H.3 in the START file. If ISWBEG is greater than ISWEND, the comparison and corrections would instead be done for grid cells located between ISWEND and the end of the grid. This error message will appear if ISWBEG is greater than ISWEND and is remedied by correcting these numbers on Line H.3.

14. ERROR FOUND IN DEPIN. FILES DEPTH (AND WAVES) CONTAIN TOO FEW VALUES. If an external wave transformation model is used to calculate the nearshore wave conditions along the nearshore reference line, as specified by setting NWD = 1 on Line B.3 in the START file, the corresponding depths and wave information are obtained from the data files DEPTH and WAVES, respectively. Following specifications of the total number of calculation cells on Line A.3 and of the grid cell numbers where the simulation starts and ends on

Line A.4, the appropriate values will be read from these files. This error message will appear if the end of the DEPTH file or WAVES file is prematurely encountered and is remedied by adding more values to the two files, changing the value of total number of calculation cells on Line A.3, or changing the grid cell numbers where the calculation starts and/or ends on Line A.4.

15. ERROR FOUND IN KDGODA. KD CALCULATION DID NOT CONVERGE. The diffracted breaking wave conditions are found by a search method that normally converges within 5 to 10 iterations. However, to avoid the risk of being trapped in an infinite loop, which, for example, can happen if the shoreline advances past a detached breakwater, the search is stopped after 20 iterations. This message will appear if the search procedure has not converged within 20 iterations, and if the error persists, it probably signals a significant flaw in the wave, depth, or structure configuration input data.

16. ERROR FOUND IN SHOIN. FILE SHORM CONTAINS TOO FEW VALUES. Following specification of the total number of calculation cells on Line A.3 and of the grid cell numbers where the simulation starts and ends on Line A.4, shoreline positions will be read from the data file SHORM in the subroutine SHOIN. This message will appear if the end of the SHORM file is prematurely encountered and is remedied by adding more values to the file, changing the value of the total number of calculation cells on Line A.3, or changing the grid cell numbers where the calculation starts and/or ends on Line A.4.

17. ERROR FOUND IN SHOIN. LAST SHORELINE BLOCK(S) OUTSIDE THE CALCULATION GRID. Following specification of the total number of calculation cells on Line A.3 and of the grid cell numbers where the simulation starts and ends on Line A.4, shoreline positions will be read from the data file SHORL in the subroutine SHOIN. This message will appear if the end of the SHORL file is prematurely encountered and is remedied by adding more values to the file, changing the value of the total number of calculation cells on Line A.3, or changing the grid cell numbers where the calculation starts and/or ends on Line A.4.

18. ERROR FOUND IN SWLIN. FILE SEAWL CONTAINS TOO FEW VALUES. Following specification of the total number of calculation cells on Line A.3 and of the grid cell numbers where the simulation starts and ends on Line A.4, seawall positions will be read from the data file SEAWL by subroutine SWLIN.

This message will appear if the end of the file is prematurely encountered in the SEAWL file and is remedied by adding more values to the file, changing the value of the total number of calculation cells on Line A.3, or changing the grid cell numbers where the calculation starts and/or ends on Line A.4.

19. ERROR FOUND IN SWLIN. LAST SEAWALL BLOCK(S) OUTSIDE THE CALCULATION GRID. Following specification of the total number of calculation cells on Line A.3 and of the grid cell numbers where the simulation starts and ends on Line A.4, seawall positions will be read from the data file SEAWL by subroutine SWLIN. This message will appear if the end of the file is prematurely encountered in the SEAWL file and is remedied by adding more values to the file, changing the value of the total number of calculation cells on Line A.3, or changing the grid cell numbers where the calculation starts and/or ends on Line A.4.

20. ERROR FOUND IN WAVIN. FILE WAVES CONTAINS TOO FEW NEARSHORE WAVE DATA POINTS. Following specification of the total number of calculation cells on Line A.3 and of the grid cell numbers where simulation starts and ends on Line A.4, offshore and nearshore wave data will be read from the data file WAVES by subroutine WAVIN. This message will appear if the end of the WAVES file is prematurely encountered while reading the nearshore wave data and is remedied by adding more values to the file, changing the value of the total number of calculation cells on Line A.3, or changing the grid cell numbers where the calculation starts and/or ends on Line A.4.

21. ERROR. GROIN CONNECTED TO A DETACHED BREAKWATER MUST BE CLASSIFIED AS A DIFFRACTING GROIN. Two of the basic structural elements in GENESIS, the groin and the detached breakwater, may be combined to produce more complex configurations, e.g., spur jetties. However, one requirement is that the groin be specified as diffracting. This error will appear if a detached breakwater is attached to a nondiffracting groin and is remedied by removing values specifying a nondiffracting groin on Lines D.4 and D.5 in the START file and placing them on Lines E.4-E.6 corresponding to a diffracting groin.

22. ERROR. GROIN NEXT TO GRID BOUNDARY. The longshore sand transport rate depends on the angle between the wave crests and the shoreline. To calculate the shoreline orientation, the shoreline location in two adjacent calculation cells is needed. At the location of groins, a straight line

between the two cells on either side of the structure is not a good representation of the local shoreline orientation. Instead, the shoreline orientation on the updrift or upwave side is used for calculating the transport rate. If the groin is on a boundary, the transport rate is calculated as a boundary condition as described in Part IV. Thus, the groin must be placed either on a boundary or at least two calculation cells away from it. This message will appear if a groin is placed one calculation cell away from either end of the numerical grid. The error is remedied by moving the groin at least one cell away from the end of grid or by moving the end of the grid at least one cell away from the groin. (See Line D.4 for nondiffracting groins and Line E.4 for diffracting groins.)

23. ERROR. GROINS MUST BE SEPARATED BY AT LEAST TWO CALCULATION CELLS. The longshore sand transport rate depends on the angle between the wave crests and the shoreline. To calculate the shoreline orientation, the shoreline location in two adjacent calculation cells is needed. At the location of groins, a straight line between the two cells on either side of the structure is not believed to be a good representation of the local shoreline orientation. Instead, the shoreline orientation on the updrift or upwave side is used for calculating the transport rate, requiring at least two cells separating each pair of groins. This message will appear if two groins are placed with only one calculation cell between them and is remedied by moving one of the groins at least one cell farther away from the other groin. (See Line D.4 for nondiffracting groins and Line E.4 for diffracting groins.)

24. ERROR IN CALCULATION OF BREAKING WAVE HEIGHT. THE WAVE DID NOT BREAK. The undiffracted breaking wave conditions are found by a search method that normally converges within 6 to 8 iterations. However, to avoid the risk of being trapped in an infinite loop, the search is stopped after 20 iterations. This error message will appear if the search procedure has not converged within 20 iterations and may be remedied by changing what is probably an unphysical wave height with respect to the nearshore depth (or vice versa). If the error persists, it probably signals a significant flaw in the wave, depth, or structure configuration input.

25. ERROR. INCORRECT FORMAT FOR BEACH FILL DATES. The dates when beach fills start are specified values of BFDATS entered on Line I.4 in the

START file. The dates when the beach fills end are specified by values of BFDATE entered on Line I.5. Each date must be entered as one number in the format YYYYDD. This error message will appear if, for any of these dates, the number of the day is greater than 31 or if the number of the month is greater than 12.

26. ERROR. INCORRECT FORMAT OF SIMULATION START DATE. The date specifying when the calculation starts is contained in the value of SIMDATS entered on Line A.6 in the START file. This date must be entered as one number in the format YYYYDD. This message will appear if the number of the day is greater than 31 or if the number of the month is greater than 12.

27. ERROR. SEAWALL IS OUTSIDE CALCULATION GRID. GENESIS has the option of performing simulations over a portion of the beach through specification of grid cell numbers other than 1 and N+1 where the simulation starts and ends. These numbers are entered on Line A.4 in the START file. To facilitate use of the model, the coordinates of seawalls, as specified on Line H.3, and other structures are always given in the total coordinate system. In this way the modeler does not have to change the coordinates of the structures if he or she targets one portion of the beach or another for modeling. However, the user must input only that part of the seawall that appears inside the portion of the beach presently being modeled. GENESIS transforms the coordinates from the total coordinate system to the local system covering a portion of the beach. This message will appear if the recalculated grid cell numbers fall outside the range of the local grid and is remedied by setting ISWBEG , on Line H.3, equal to the grid cell number where the simulation starts if the right side of the seawall is outside the grid or by setting ISWEND equal to the grid cell number where the simulation ends if the left side of the seawall is outside the grid.

28. ERROR. SIMULATION ENDING DATE MUST BE GREATER THAN THE STARTING DATE. The ending date of the simulation as specified on Line A.7 in the START file must be given as one number in format YYYYDD. If an incorrect format is used, GENESIS may interpret the ending date as earlier than the start date.

29. ERROR. SMALL GROIN OUTSIDE CALCULATION GRID. GENESIS has the option of performing simulations over a portion of the beach through specification of grid cell numbers other than 1 and N+1 where the simulation

starts and ends. These numbers are entered on Line A.4 in the START file. To facilitate use of the model, the coordinates of small groins, as specified on Line D.4, and other structures are given in the total coordinate system. In this way the modeler does not have to change the coordinates of the structures as he or she targets one portion of the beach or another for modeling. However, only those structures that appear inside the portion of the beach being modeled should be specified. GENESIS transforms the coordinates from the total coordinate system to the local system covering a portion of the beach. This message will appear if the recalculated grid cell numbers fall outside the range of the local grid and is remedied by omitting these grid cell numbers from Line D.4 and the corresponding lengths on Line D.5.

30. ERROR. TOO MANY BEACH FILLS. Many arrays in the FORTRAN code depend on the number of beach fills. The largest possible number is 50. This error message will appear if NBF on Line I.3 is greater than 50 and is remedied by reducing NBF accordingly. As NBF is changed, corresponding changes must be introduced on Lines I.4 and I.5, as the number of data entries on these lines must correspond to the number of beach fills as specified on Line I.3. The number of beach fills can be reduced by splitting up the beach in portions and then performing the simulations for one portion of the beach at a time.

31. ERROR. TOO MANY DETACHED BREAKWATERS. Many arrays in the FORTRAN code depend on the number of detached breakwaters. The largest possible number is 20. This message will appear if NDB on Line G.3 is greater than 20 and is remedied by reducing NDB accordingly. As NDB is changed, corresponding changes must be introduced on Lines G.4 to G.9, as the number of data entries on these lines must correspond to the number of structures as specified on Line G.3. The number of structures can be reduced by splitting up the beach in portions and then performing the simulations for one portion of the beach at a time.

32. ERROR. TOO MANY DIFFRACTING GROINS. Many arrays in the FORTRAN code depend on the number of diffracting groins. The largest possible number is 20. This error will appear if NDG on Line E.3 is greater than 20 and is remedied by reducing NDG accordingly. As NDG is changed, corresponding changes must be introduced on Lines E.4 to E.6, as the number of data entries

on these lines must correspond to the number of structures as specified on Line E.3. The number of structures can be reduced by splitting up the beach in portions and then performing the simulations for one portion of the beach at the time.

33. ERROR. TOO MANY INTERMEDIATE PRINTOUTS REQUESTED. Many arrays in the FORTRAN code depend on the number of requested printouts. The largest possible number is 30. This error message will appear if the variable NOUT on Line A.8 in the START file is greater than 30 and is remedied by reducing NOUT accordingly.

34. ERROR. TOO MANY NONDIFFRACTING GROINS. Many arrays in the FORTRAN code depend on the number of nondiffracting groins. The largest possible number is 50. This error message will appear if NNDG on Line D.3 is greater than 50 and is remedied by changing NNDG accordingly. As NNDG is changed, corresponding changes must be introduced on Lines D.4 and D.5, as the number of data entries on these lines must correspond to the number of structures as specified on Line D.3. The number of structures can be reduced by splitting up the beach in portions and then performing the simulations for one portion of the beach at a time.

35. ERROR. TOO MANY SHORELINE CELLS. Many arrays in the FORTRAN code depend on the number of shoreline cells alongshore. The largest possible number is 600. This message will appear if NN on Line A.3 in the START file is greater than 600 and is remedied by reducing NN accordingly.

36. ERROR. WAVE DATA FILE STARTS LATER THAN THE SIMULATION. If the simulation starts later than the starting date of the wave data file as specified on Line B.8, GENESIS will read over lines in the WAVES file until the wave input corresponding to the simulation starting date is found. This date must be given as one number in the format YYMMDD. If the wave data file is specified to start later than the simulation, the corresponding date will never be found.

37. ERROR. WRONG VALUE OF "ICONV". GENESIS performs calculations in length units of either meters or feet according to the value of ICONV entered on Line A.2 in the START file. This message will appear if any other number but 1 (meters) or 2 (feet) is given for ICONV.

Warning Messages

38. WARNING. INPUT WAVE ALREADY BROKEN. In the use of GENESIS, wave transformation from deep to shallow water can be performed using an internal or an external wave transformation model. If an external wave model is used, wave transformation over the actual (irregular) bathymetry is calculated starting at the defined offshore depth. Resultant values of wave height and direction alongshore at a depth such that wave breaking has not yet occurred are placed in a file (by external manipulations by the modeler) for input to the internal wave model of GENESIS. These depths (for example, the depths in each wave calculation cell at the nominal 6-m or 20-ft contour) define a "nearshore reference line" from which the internal wave model takes over grid cell by grid cell to bring the waves to the breakpoint. This message is issued if the wave height on the reference line exceeds the depth-limited wave height as given by the relation $H_b = \gamma D_b$. This condition is remedied by either decreasing the input wave height in the WAVES file or by increasing the reference depth in the DEPTH file.

39. WARNING. THE STABILITY PARAMETER IS _____. The numerical stability of the calculation scheme is expressed by the stability parameter R_s . The magnitude of the stability parameter also indicates the numerical accuracy of the solution. GENESIS calculates the value of R_s at each time step at each grid point alongshore and determines the maximum value. If $R_s > 5$ for any grid point, a message is issued. The condition can be eliminated by either decreasing the time step DT at Line A.5 or by increasing the grid cell size DX at Line A.3. Normally the time step is reduced since considerable effort is involved in developing a grid.

40. WARNING. TRANSPORT CALCULATIONS DIFFER. A seawall imposes a constraint on the position of the shoreline since the shoreline cannot move landward of the wall. GENESIS first calculates longshore sand transport rates along the beach based on the assumption that the calculated amount of sand is available for transport. At grid cells where the seawall constraint is violated, the shoreline position and the transport rate are adjusted. Corresponding quantities in neighboring cells are also adjusted to preserve sand

volume and the direction of transport. The transport calculation has to be performed in the same direction as the direction of transport. Therefore, two independent algorithms, one calculating the transport rates from grid cells 1 to N+1 and one calculating in reverse order, are needed. These algorithms should give the same transport rate. However, for large values of the stability parameter or because of the presence of detached breakwaters, especially if they are transmissive, the two algorithms may give slightly different results. This message is issued if the difference in the two calculated transport rates is greater than 0.0005 m³/sec at any cell along-shore. This condition is remedied by decreasing the stability ratio, which in turn is done by decreasing the time step, increasing the grid cell size, or decreasing the wave height. Extremely high angles of wave incidence may also produce this error. In addition to the reporting the actual transport rate difference, the shoreline change resulting from this difference is also reported.

41. **WARNING. UNPHYSICAL DEEPWATER WAVE STEEPNESS.** The input offshore wave data may be manipulated, for example, to investigate model sensitivity or the effect of extreme conditions. In these investigations the wave height is often increased, and, if care is not taken, it is possible to accidentally specify waves of unphysically large steepness. GENESIS checks that the offshore wave steepness does not exceed the value of 0.142, and, if it does, reduces the deepwater wave height to satisfy this condition. This message is issued if the wave steepness exceeds 0.142 and is remedied by decreasing the wave height or increasing the input wave period in the WAVES file.

Error Messages Issued by the Computer

42. Even though much effort was devoted to making the data input procedure as straightforward and error-free as possible, it is inevitable that mistakes will be made in preparing input files. As a result of mismatch errors between read instructions in GENESIS and the improper content of a data file, a computer will issue error messages that may be obscure and difficult to interpret. Experience indicates that the most common input errors occur in the START file. In this case the computer system may issue a message about an

input error in Unit 10, which means the START file, and will also give the line number in the FORTRAN code where the error occurs.

APPENDIX D: INPUT AND OUTPUT FILES FOR CASE STUDY

43. This appendix gives the contents of the input files used for the case study and the resultant output files.

START Files

File START_INIT representing the first version of the START file.

```
A----- MODEL SETUP -----A
A.1 RUN TITLE
    LAKEVIEW PARK CASE STUDY, MAY-JUNE 1989, PRELIMINARY RUN
A.2 INPUT UNITS (METERS=1; FEET=2): ICONV
    2
A.3 TOTAL NUMBER OF CALCULATION CELLS AND CELL LENGTH: NN, DX
    49 25
A.4 GRID CELL NUMBER WHERE SIMULATION STARTS AND NUMBER OF CALCULATION
    CELLS (N = -1 MEANS N = NN): ISSTART, N
    1 -1
A.5 VALUE OF TIME STEP IN HOURS: DT
    6
A.6 DATE WHEN SHORELINE SIMULATION STARTS
    (DATE FORMAT YYMMDD: 1 MAY 1992 = 920501): SIMDATS
    771001
A.7 DATE WHEN SHORELINE SIMULATION ENDS OR TOTAL NUMBER OF TIME STEPS
    (DATE FORMAT YYMMDD: 1 MAY 1992 = 920501): SIMDATE
    771024
A.8 NUMBER OF INTERMEDIATE PRINT-OUTS WANTED: NOUT
    0
A.9 DATES OR TIME STEPS OF INTERMEDIATE PRINT-OUTS
    (DATE FORMAT YYMMDD: 1 MAY 1992 = 920501, NOUT VALUES): TOUT(I)
A.10 NUMBER OF CALCULATION CELLS IN OFFSHORE CONTOUR SMOOTHING WINDOW
    (ISMOOTH = 0 MEANS NO SMOOTHING, ISMOOTH = N MEANS STRAIGHT LINE.
    RECOMMENDED VALUE = 11): ISMOOTH
    11
A.11 REPEATED WARNING MESSAGES (YES=1; NO=0): IRWM
    1
A.12 LONGSHORE SAND TRANSPORT CALIBRATION COEFFICIENTS: K1, K2
    .77 .0
A.13 PRINT-OUT OF TIME STEP NUMBERS? (YES=1, NO=0): IPRINT
    0
B----- WAVES -----B
B.1 WAVE HEIGHT CHANGE FACTOR. WAVE ANGLE CHANGE FACTOR AND AMOUNT (DEG)
    (NO CHANGE: HCNGF=1, ZCNGF=1, ZCNCA=0): HCNGF, ZCNGF, ZCNCA
    1 1 0
B.2 DEPTH OF OFFSHORE WAVE INPUT: DZ
    30
B.3 IS AN EXTERNAL WAVE MODEL BEING USED (YES=1; NO=0): NWD
    0
```

B.4 COMMENT: IF AN EXTERNAL WAVE MODEL IS NOT BEING USED, CONTINUE TO B.6

B.5 NUMBER OF SHORELINE CALCULATION CELLS PER WAVE MODEL ELEMENT: ISPW

B.6 VALUE OF TIME STEP IN WAVE DATA FILE IN HOURS (MUST BE AN EVEN MULTIPLE OF, OR EQUAL TO DT): DTW
6

B.7 NUMBER OF WAVE COMPONENTS PER TIME STEP: N WAVES
1

B.8 DATE WHEN WAVE FILE STARTS (FORMAT YYMMDD: 1 MAY 1992 = 920501): WDATS
770101

C----- BEACH -----C

C.1 EFFECTIVE GRAIN SIZE DIAMETER IN MILLIMETERS: D50
0.4

C.2 AVERAGE BERM HEIGHT FROM MEAN WATER LEVEL: ABH
8

C.3 CLOSURE DEPTH: DCLOS
16

D----- NONDIFFRACTING GROINS -----D

D.1 ANY NONDIFFRACTING GROINS? (NO=0, YES=1): INDG
1

D.2 COMMENT: IF NO NONDIFFRACTING GROINS, CONTINUE TO E.

D.3 NUMBER OF NONDIFFRACTING GROINS: NNDG
2

D.4 GRID CELL NUMBERS OF NONDIFFRACTING GROINS (NNDG VALUES): IXNDG(I)
1 50

D.5 LENGTHS OF NONDIFFRACTING GROINS FROM X-AXIS (NNDG VALUES): YNDG(I)
164 360

E----- DIFFRACTING (LONG) GROINS AND JETTIES -----E

E.1 ANY DIFFRACTING GROINS OR JETTIES? (NO=0, YES=1): IDG
0

E.2 COMMENT: IF NO DIFFRACTING GROINS, CONTINUE TO F.

E.3 NUMBER OF DIFFRACTING GROINS/JETTIES: NDG

E.4 GRID CELL NUMBERS OF DIFFRACTING GROINS/JETTIES (NDG VALUES): IXDG(I)

E.5 LENGTHS OF DIFFRACTING GROINS/JETTIES FROM X-AXIS (NDG VALUES): YDG(I)

E.6 DEPTHS AT SEAWARD END OF DIFFRACTING GROINS/JETTIES(NDG VALUES): DDG(I)

F----- ALL GROINS/JETTIES -----F

F.1 COMMENT: IF NO GROINS OR JETTIES, CONTINUE TO G.

F.2 REPRESENTATIVE BOTTOM SLOPE NEAR GROINS: SLOPE2
0.056 (1:18)

F.3 PERMEABILITIES OF ALL GROINS AND JETTIES (NNDG+NDG VALUES): PERM(I)
0.0 0.0

F.4 IF GROIN OR JETTY ON LEFT-HAND BOUNDARY, DISTANCE FROM SHORELINE
OUTSIDE GRID TO SEAWARD END OF GROIN OR JETTY: YG1
35

F.5 IF GROIN OR JETTY ON RIGHT-HAND BOUNDARY, DISTANCE FROM SHORELINE
OUTSIDE GRID TO SEAWARD END OF GROIN OR JETTY: YGN
240

G----- DETACHED BREAKWATERS -----G

- G.1 ANY DETACHED BREAKWATERS? (NO=0, YES=1): IDB
1
- G.2 COMMENT: IF NO DETACHED BREAKWATERS, CONTINUE TO H.
- G.3 NUMBER OF DETACHED BREAKWATERS: NDB
3
- G.4 ANY DETACHED BREAKWATER ACROSS LEFT-HAND CALCULATION BOUNDARY
(NO=0, YES=1): IDB1
0
- G.5 ANY DETACHED BREAKWATER ACROSS RIGHT-HAND CALCULATION BOUNDARY
(NO=0, YES=1): IDBN
0
- G.6 GRID CELL NUMBERS OF TIPS OF DETACHED BREAKWATERS
(2 * NDB - (IDB1+IDBN) VALUES): IXDB(I)
2 12 18 28 34 44
- G.7 DISTANCES FROM X-AXIS TO TIPS OF DETACHED BREAKWATERS
(1 VALUE FOR EACH TIP SPECIFIED IN G.6): YDB(I)
445 477 498 509 525 525
- G.8 DEPTHS AT DETACHED BREAKWATER TIPS (1 VALUE FOR EACH TIP
SPECIFIED IN G.6): DDB(I)
10 10.5 11 11.5 11.7 11.7
- G.9 DETACHED BREAKWATER TRANSMISSION COEFFICIENTS (NDB VALUES: TRANDB(I)
0 0 0

H----- SEAWALLS -----H

- H.1 ANY SEAWALL ALONG THE SIMULATED SHORELINE? (YES=1; NO=0): ISW
1
- H.2 COMMENT: IF NO SEAWALL, CONTINUE TO I.
- H.3 GRID CELL NUMBERS OF START AND END OF SEAWALL (ISWEND = -1 MEANS
ISWEND = N): ISWBEG, ISWEND
1 -1

I----- BEACH FILLS -----I

- I.1 ANY BEACH FILLS DURING SIMULATION PERIOD? (NO=0, YES=1): IBF
0
- I.2 COMMENT: IF NO BEACH FILLS, CONTINUE TO K.
- I.3 NUMBER OF BEACH FILLS DURING SIMULATION PERIOD: NBF
- I.4 DATES OR TIME STEPS WHEN THE RESPECTIVE FILLS START
(DATE FORMAT YYYYMMDD: 1 MAY 1992 = 920501, NBF VALUES): BFDATS(I)
- I.5 DATES OR TIME STEPS WHEN THE RESPECTIVE FILLS END
(DATE FORMAT YYYYMMDD: 1 MAY 1992 = 920501, NBF VALUES): BFDATE(I)
- I.6 GRID CELL NUMBERS OF START OF RESPECTIVE FILLS (NBF VALUES): IBFS(I)
- I.7 GRID CELL NUMBERS OF END OF RESPECTIVE FILLS (NBF VALUES): IBFE(I)
- I.8 ADDED BERM WIDTHS AFTER ADJUSTMENT TO EQUILIBRIUM CONDITIONS
(NBF VALUES): YADD(I)

----- END -----

File START_CAL representing the calibrated version of the START file.

```
A----- MODEL SETUP -----A
A.1 RUN TITLE
    LAKEVIEW PARK CASE STUDY, MAY-JUNE 1989, CALIBRATION
A.2 INPUT UNITS (METERS=1; FEET=2): ICONV
    2
A.3 TOTAL NUMBER OF CALCULATION CELLS AND CELL LENGTH: NN, DX
    49 25
A.4 GRID CELL NUMBER WHERE SIMULATION STARTS AND NUMBER OF CALCULATION
    CELLS (N = -1 MEANS N = NN): ISSTART, N
    1 -1
A.5 VALUE OF TIME STEP IN HOURS: DT
    0.3
A.6 DATE WHEN SHORELINE SIMULATION STARTS
    (DATE FORMAT YYMMDD: 1 MAY 1992 = 920501): SIMDATS
    771024
A.7 DATE WHEN SHORELINE SIMULATION ENDS OR TOTAL NUMBER OF TIME STEPS
    (DATE FORMAT YYMMDD: 1 MAY 1992 = 920501): SIMDATE
    781009
A.8 NUMBER OF INTERMEDIATE PRINT-OUTS WANTED: NOUT
    0
A.9 DATES OR TIME STEPS OF INTERMEDIATE PRINT-OUTS
    (DATE FORMAT YYMMDD: 1 MAY 1992 = 920501, NOUT VALUES): TOUT(I)
A.10 NUMBER OF CALCULATION CELLS IN OFFSHORE CONTOUR SMOOTHING WINDOW
    (ISMOOTH = 1 MEANS NO SMOOTHING, ISMOOTH = N MEANS STRAIGHT LINE.
    RECOMMENDED VALUE = 11): ISMOOTH
    11
A.11 REPEATED WARNING MESSAGES (YES=1; NO=0): IRWM
    1
A.12 LONGSHORE SAND TRANSPORT CALIBRATION COEFFICIENTS: K1, K2
    .42 .12
A.13 PRINT-OUT OF TIME STEP NUMBERS? (YES=1, NO=0): IPRINT
    0
B----- WAVES -----B
B.1 WAVE HEIGHT CHANGE FACTOR. WAVE ANGLE CHANGE FACTOR AND AMOUNT (DEG)
    (NO CHANGE: HCNGF=1, ZCNGF=1, ZCNGA=0): HCNGF, ZCNGF, ZCNGA
    1 1 0
B.2 DEPTH OF OFFSHORE WAVE INPUT: DZ
    30
B.3 IS AN EXTERNAL WAVE MODEL BEING USED (YES=1; NO=0): NWD
    0
B.4 COMMENT: IF AN EXTERNAL WAVE MODEL IS NOT BEING USED, CONTINUE TO B.6
B.5 NUMBER OF SHORELINE CALCULATION CELLS PER WAVE MODEL ELEMENT: ISPW
B.6 VALUE OF TIME STEP IN WAVE DATA FILE IN HOURS (MUST BE AN EVEN MULTIPLE
    OF, OR EQUAL TO DT): DTW
    6
B.7 NUMBER OF WAVE COMPONENTS PER TIME STEP: N WAVES
    1
```

B.8 DATE WHEN WAVE FILE STARTS (FORMAT YYMMDD: 1 MAY 1992 - 920501): WDATS
770101

C----- BEACH -----C

C.1 EFFECTIVE GRAIN SIZE DIAMETER IN MILLIMETERS: D50
0.4

C.2 AVERAGE BERM HEIGHT FROM MEAN WATER LEVEL: ABH
8

C.3 CLOSURE DEPTH: DCLOS
16

D----- NONDIFFRACTING GROINS -----D

D.1 ANY NONDIFFRACTING GROINS? (NO=0, YES=1): INDG
1

D.2 COMMENT: IF NO NONDIFFRACTING GROINS, CONTINUE TO E.

D.3 NUMBER OF NONDIFFRACTING GROINS: NNDG
2

D.4 GRID CELL NUMBERS OF NONDIFFRACTING GROINS (NNDG VALUES): IXNDG(I)
1 50

D.5 LENGTHS OF NONDIFFRACTING GROINS FROM X-AXIS (NNDG VALUES): YNDG(I)
164 360

E----- DIFFRACTING (LONG) GROINS AND JETTIES -----E

E.1 ANY DIFFRACTING GROINS OR JETTIES? (NO=0, YES=1): IDG
0

E.2 COMMENT: IF NO DIFFRACTING GROINS, CONTINUE TO F.

E.3 NUMBER OF DIFFRACTING GROINS/JETTIES: NDG

E.4 GRID CELL NUMBERS OF DIFFRACTING GROINS/JETTIES (NDG VALUES): IXDG(I)

E.5 LENGTHS OF DIFFRACTING GROINS/JETTIES FROM X-AXIS (NDG VALUES): YDG(I)

E.6 DEPTHS AT SEAWARD END OF DIFFRACTING GROINS/JETTIES(NDG VALUES): DDG(I)

F----- ALL GROINS/JETTIES -----F

F.1 COMMENT: IF NO GROINS OR JETTIES, CONTINUE TO G.

F.2 REPRESENTATIVE BOTTOM SLOPE NEAR GROINS: SLOPE2
0.056 (1:18)

F.3 PERMEABILITIES OF ALL GROINS AND JETTIES (NNDG+NDG VALUES): PERM(I)
0.0 0.0

F.4 IF GROIN OR JETTY ON LEFT-HAND BOUNDARY, DISTANCE FROM SHORELINE
OUTSIDE GRID TO SEAWARD END OF GROIN OR JETTY: YG1
70

F.5 IF GROIN OR JETTY ON RIGHT-HAND BOUNDARY, DISTANCE FROM SHORELINE
OUTSIDE GRID TO SEAWARD END OF GROIN OR JETTY: YGN
180

G----- DETACHED BREAKWATERS -----G

G.1 ANY DETACHED BREAKWATERS? (NO=0, YES=1): IDB
1

G.2 COMMENT: IF NO DETACHED BREAKWATERS, CONTINUE TO H.

G.3 NUMBER OF DETACHED BREAKWATERS: NDB
3

G.4 ANY DETACHED BREAKWATER ACROSS LEFT-HAND CALCULATION BOUNDARY
(NO=0, YES=1): IDB1
0

G.5 ANY DETACHED BREAKWATER ACROSS RIGHT-HAND CALCULATION BOUNDARY
(NO=0, YES=1): IDBN
0

G.6 GRID CELL NUMBERS OF TIPS OF DETACHED BREAKWATERS
(2 * NDB - (IDB1+IDBN) VALUES): IXDB(I)
2 12 18 28 36 46

G.7 DISTANCES FROM X-AXIS TO TIPS OF DETACHED BREAKWATERS
(1 VALUE FOR EACH TIP SPECIFIED IN G.6): YDB(I)
445 477 498 509 525 525

G.8 DEPTHS AT DETACHED BREAKWATER TIPS (1 VALUE FOR EACH TIP
SPECIFIED IN G.6): DDB(I)
10 10.5 11 11.5 11.7 11.7

G.9 DETACHED BREAKWATER TRANSMISSION COEFFICIENTS (NDB VALUES): TRANDB(I)
0.5 0.22 0.3

H----- SEAWALLS -----H

H.1 ANY SEAWALL ALONG THE SIMULATED SHORELINE? (YES=1; NO=0): ISW
1

H.2 COMMENT: IF NO SEAWALL, CONTINUE TO I.

H.3 GRID CELL NUMBERS OF START AND END OF SEAWALL (ISWEND = -1 MEANS
ISWEND = N): ISWBEG, ISWEND
1 -1

I----- BEACH FILLS -----I

I.1 ANY BEACH FILLS DURING SIMULATION PERIOD? (NO=0, YES=1): IBF
0

I.2 COMMENT: IF NO BEACH FILLS, CONTINUE TO K.

I.3 NUMBER OF BEACH FILLS DURING SIMULATION PERIOD: NBF

I.4 DATES OR TIME STEPS WHEN THE RESPECTIVE FILLS START
(DATE FORMAT YYMMDD: 1 MAY 1992 = 920501, NBF VALUES): BFDATS(I)

I.5 DATES OR TIME STEPS WHEN THE RESPECTIVE FILLS END
(DATE FORMAT YYMMDD: 1 MAY 1992 = 920501, NBF VALUES): BFDATE(I)

I.6 GRID CELL NUMBERS OF START OF RESPECTIVE FILLS (NBF VALUES): IBFS(I)

I.7 GRID CELL NUMBERS OF END OF RESPECTIVE FILLS (NBF VALUES): IBFE(I)

I.8 ADDED BERM WIDTHS AFTER ADJUSTMENT TO EQUILIBRIUM CONDITIONS
(NBF VALUES): YADD(I)

----- END -----

File START_VER representing the verified version of the START file. Only lines that are different from those in START_CAL are shown.

```
A----- MODEL SETUP -----A
A.1 RUN TITLE
    LAKEVIEW PARK CASE STUDY, MAY-JUNE 1989, VERIFICATION
A.6 DATE WHEN SHORELINE SIMULATION STARTS
    (DATE FORMAT YYMMDD: 1 MAY 1992 = 920501): SIMDATS
    781009
A.7 DATE WHEN SHORELINE SIMULATION ENDS OR TOTAL NUMBER OF TIME STEPS
    (DATE FORMAT YYMMDD: 1 MAY 1992 = 920501): SIMDATE
    791117

B----- WAVES -----B
B.8 DATE WHEN WAVE FILE STARTS (FORMAT YYMMDD: 1 MAY 1992 = 920501): WDATS
    780101

F----- ALL GROINS/JETTIES -----F
F.4 IF GROIN OR JETTY ON LEFT-HAND BOUNDARY, DISTANCE FROM SHORELINE
    OUTSIDE GRID TO SEAWARD END OF GROIN OR JETTY: YG1
    128
----- END -----
```

SHORL Files

File SHORL_771024 holding shoreline position 24 October 1977. DX = 25 ft.

SHORL.DAT HOLDS SHORELINE POSITIONS. MUST CONTAIN NN VALUES.

EXACTLY 10 ENTRIES ON EACH LINE! LVP, 771024

151.2	154.2	157.2	162.2	173.2	194.2	212.2	215.2	220.2	220.2
218.2	215.2	212.2	210.2	210.2	212.2	215.2	226.2	233.2	244.2
255.2	263.2	273.2	279.2	281.2	284.2	279.2	273.2	263.2	257.2
255.2	257.2	263.2	273.2	279.2	287.2	295.2	295.2	295.2	295.2
297.2	292.2	287.2	281.2	279.2	273.2	271.2	263.2	252.2	

File SHORL_781009 holding shoreline position 9 October 1978. DX = 25 ft.

SHORL.DAT HOLDS SHORELINE POSITIONS. MUST CONTAIN NN VALUES.

EXACTLY 10 ENTRIES ON EACH LINE! LVP, 781009

131.4	139.4	148.4	158.4	168.4	183.4	191.4	202.4	208.4	208.4
207.4	208.4	209.4	213.4	217.4	216.4	219.4	227.4	238.4	249.4
264.4	277.4	283.4	279.4	275.4	272.4	273.4	278.4	275.4	273.4
272.4	269.4	270.4	272.4	277.4	282.4	289.4	299.4	310.4	320.4
325.4	318.4	307.4	301.4	296.4	294.4	285.4	281.4	276.4	

File SHORL_791117 holding shoreline position 17 November 1979. DX = 25 ft.

SHORL.DAT HOLDS SHORELINE POSITIONS. MUST CONTAIN NN VALUES.

EXACTLY 10 ENTRIES ON EACH LINE! LVP, 791117

86.5	92.5	101.5	109.5	127.5	144.5	161.5	172.5	184.5	198.5
202.5	203.5	205.5	204.5	205.5	211.5	219.5	229.5	238.5	250.5
263.5	277.5	297.5	305.5	303.5	292.5	283.5	272.5	268.5	269.5
268.5	267.5	270.5	272.5	279.5	290.5	305.5	318.5	330.5	339.5
345.5	349.5	349.5	334.5	325.5	315.5	304.5	294.5	289.5	

SEAWL File

File SEAWL holding seawall position. DX = 25 ft.

SEAWL.DAT HOLDS SEAWALL POSITIONS. MUST CONTAIN NN VALUES.

EXACTLY 10 ENTRIES ON EACH LINE! LAKEVIEW PARK. DX = 25 FT.

-84.0	-45.0	-39.0	-41.0	-41.9	-42.8	-43.7	-44.6	-45.5	-46.4
-47.3	-48.2	-49.0	-49.9	-50.8	-51.7	-52.6	-53.5	-54.4	-55.3
-56.2	-57.1	-58.0	-58.9	-27.0	-27.0	-27.0	-27.0	-27.0	-76.0
-68.0	-63.0	-57.0	-53.0	-50.0	-48.0	-47.0	-49.0	-52.0	-54.0
-57.0	-60.0	-62.0	-63.0	-120.5	-178.0	-180.0	-182.0	-184.0	

WAVES File

File WAVES_LVP holding wave data for a representative year. DT = 6 hrs.

WAVES FOR LAKEVIEW PARK. PRODUCED USING TM 37, SAVILLE, 1953.
SHADOWING FROM THE HARBOR & ICE FROM DECEMBER TO MARCH ACCOUNTED FOR.

-0.00 0.00 0.00 JAN
-0.00 0.00 0.00
-0.00 0.00 0.00
-0.00 0.00 0.00

. . .
.
(wave data are given
in tabular form below)

. . .
.
-0.00 0.00 0.00

Wave data in wave file WAVES_LVP.DAT:

T	H	α	T	H	α	T	H	α
-0.00	0.00	0.00 J	4.00	0.86	-10.00	4.00	0.86	-10.00
-0.00	0.00	0.00 A	6.00	1.76	-30.00	8.00	2.40	60.00
-0.00	0.00	0.00 N	4.00	0.86	-10.00	4.00	0.86	-10.00
.	.	.	4.00	0.86	-10.00	4.00	0.86	-10.00
.	.	.	8.00	3.06	-33.00	8.00	5.59	60.00
(a total of 360			4.00	0.86	-10.00	4.00	0.86	-10.00
"zero" lines from			4.00	0.86	-10.00	4.00	0.86	-10.00
Jan 1 to Mar 31)			8.00	2.45	-33.00	7.00	2.00	60.00
.			4.00	0.86	-10.00	4.00	0.86	-10.00
.			4.00	0.86	-10.00	4.00	0.86	-10.00
-0.00	0.00	0.00	6.00	2.20	-30.00	8.00	2.40	38.00
-0.00	0.00	0.00	4.00	0.86	-10.00	4.00	0.86	-10.00
-0.00	0.00	0.00	4.00	0.86	-10.00	4.00	0.86	-10.00
6.00	1.60	38.00 A	6.00	1.93	-8.00	8.00	2.00	38.00
4.00	0.86	-10.00 P	4.00	0.86	-10.00	4.00	0.86	-10.00
4.00	0.86	-10.00 R	4.00	0.86	-10.00	4.00	0.86	-10.00
5.00	1.19	38.00	6.00	1.93	-8.00	8.00	2.67	15.00
4.00	0.86	-10.00	4.00	0.86	-10.00	4.00	0.86	-10.00
4.00	0.86	-10.00	4.00	0.86	-10.00	4.00	0.86	-10.00
6.00	1.75	15.00	6.00	2.36	38.00	7.00	3.02	15.00
4.00	0.86	-10.00	4.00	0.86	-10.00	4.00	0.86	-10.00
4.00	0.86	-10.00	4.00	0.86	-10.00	4.00	0.86	-10.00
6.00	1.93	-8.00	8.00	2.40	38.00	8.00	3.91	-8.00
4.00	0.86	-10.00	4.00	0.86	-10.00	4.00	0.86	-10.00
4.00	0.86	-10.00	4.00	0.86	-10.00	4.00	0.86	-10.00
6.00	1.93	-8.00	8.00	2.40	38.00	8.00	2.65	-30.00
4.00	0.86	-10.00	4.00	0.86	-10.00	4.00	0.86	-10.00

4.00 0.86 -10.00
6.00 1.26 -33.00
4.00 0.86 -10.00
4.00 0.86 -10.00
6.00 1.26 -33.00
4.00 0.86 -10.00
4.00 0.86 -10.00
6.00 1.76 -30.00
4.00 0.86 -10.00
4.00 0.86 -10.00
8.00 3.10 -30.00
4.00 0.86 -10.00
4.00 0.86 -10.00
8.00 3.91 -8.00
4.00 0.86 -10.00
4.00 0.86 -10.00
8.00 2.96 -8.00
4.00 0.86 -10.00
4.00 0.86 -10.00
8.00 3.46 15.00
4.00 0.86 -10.00
4.00 0.86 -10.00
8.00 3.46 15.00
4.00 0.86 -10.00
4.00 0.86 -10.00
8.00 3.56 38.00
4.00 0.86 -10.00
4.00 0.86 -10.00
8.00 4.33 15.00
4.00 0.86 -10.00
4.00 0.86 -10.00
8.00 4.33 15.00
4.00 0.86 -10.00
4.00 0.86 -10.00
8.00 2.96 -8.00
4.00 0.86 -10.00
4.00 0.86 -10.00
8.00 5.20 15.00
4.00 0.86 -10.00
4.00 0.86 -10.00
8.00 3.59 38.00
4.00 0.86 -10.00
4.00 0.86 -10.00
6.00 2.39 60.00
4.00 0.86 -10.00
4.00 0.86 -10.00
8.00 5.56 38.00
4.00 0.86 -10.00
4.00 0.86 -10.00
8.00 4.35 15.00
4.00 0.86 -10.00
4.00 0.86 -10.00

6.00 1.04 -8.00 M
4.00 0.86 -10.00 A
4.00 0.86 -10.00 Y
6.00 1.04 -8.00
4.00 0.86 -10.00
4.00 0.86 -10.00
6.00 1.04 -8.00
4.00 0.86 -10.00
4.00 0.86 -10.00
6.00 0.90 -30.00
4.00 0.86 -10.00
4.00 0.86 -10.00
6.00 0.90 -30.00
4.00 0.86 -10.00
4.00 0.86 -10.00
6.00 0.90 -30.00
4.00 0.86 -10.00
4.00 0.86 -10.00
6.00 1.04 -8.00
4.00 0.86 -10.00
4.00 0.86 -10.00
6.00 1.04 -8.00
4.00 0.86 -10.00
4.00 0.86 -10.00
6.00 2.89 -8.00
4.00 0.86 -10.00
4.00 0.86 -10.00
5.00 2.39 -8.00
4.00 0.86 -10.00
4.00 0.86 -10.00
6.00 2.64 -30.00
4.00 0.86 -10.00
4.00 0.86 -10.00
6.00 2.64 -30.00
4.00 0.86 -10.00
4.00 0.86 -10.00
6.00 0.49 -33.00
4.00 0.86 -10.00
4.00 0.86 -10.00
8.00 1.01 -33.00
4.00 0.86 -10.00
4.00 0.86 -10.00
8.00 1.85 -33.00
4.00 0.86 -10.00
4.00 0.86 -10.00
8.00 2.47 -33.00

4.00 0.86 -10.00
8.00 1.01 -33.00
4.00 0.86 -10.00
4.00 0.86 -10.00
6.00 0.49 -33.00
4.00 0.86 -10.00
4.00 0.86 -10.00
6.00 0.49 -33.00
4.00 0.86 -10.00
4.00 0.86 -10.00
6.00 2.20 -30.00
4.00 0.86 -10.00
4.00 0.86 -10.00
8.00 2.65 -30.00
4.00 0.86 -10.00
8.00 2.56 -8.00
4.00 0.86 -10.00
4.00 0.86 -10.00
7.00 1.34 15.00
4.00 0.86 -10.00
4.00 0.86 -10.00
8.00 2.40 38.00
4.00 0.86 -10.00
4.00 0.86 -10.00
8.00 5.15 38.00
4.00 0.86 -10.00
8.00 4.80 60.00
4.00 0.86 -10.00
4.00 0.86 -10.00
8.00 2.40 38.00
4.00 0.86 -10.00
4.00 0.86 -10.00
6.00 1.60 38.00
4.00 0.86 -10.00
4.00 0.86 -10.00
8.00 2.67 15.00
4.00 0.86 -10.00
8.00 3.46 15.00
4.00 0.86 -10.00
4.00 0.86 -10.00
8.00 3.91 -8.00
4.00 0.86 -10.00
4.00 0.86 -10.00
8.00 3.54 -30.00
4.00 0.86 -10.00
4.00 0.86 -10.00
8.00 3.98 -30.00
4.00 0.86 -10.00
8.00 2.47 -33.00
4.00 0.86 -10.00
4.00 0.86 -10.00
8.00 2.97 -33.00

4.00 0.86 -10.00
4.00 0.86 -10.00
8.00 2.47 -33.00
4.00 0.86 -10.00
4.00 0.86 -10.00
8.00 1.85 -33.00
4.00 0.86 -10.00
4.00 0.86 -10.00
5.00 0.56 -33.00
4.00 0.86 -10.00
4.00 0.86 -10.00
4.00 0.86 -10.00
8.00 2.65 -30.00
4.00 0.86 -10.00
4.00 0.86 -10.00
8.00 3.91 -8.00
4.00 0.86 -10.00
4.00 0.86 -10.00
8.00 4.42 -8.00
4.00 0.86 -10.00
4.00 0.86 -10.00

4.00 0.95 -8.00 J
4.00 0.86 -10.00 U
4.00 0.86 -10.00 N
4.00 0.86 -10.00
4.00 1.31 -30.00
4.00 0.86 -10.00
4.00 0.86 -10.00
4.00 0.86 -10.00
6.00 1.93 -8.00
4.00 0.86 -10.00
4.00 0.86 -10.00
4.00 0.86 -10.00
6.00 1.93 -8.00
4.00 0.86 -10.00
4.00 0.86 -10.00
4.00 0.86 -10.00
5.00 1.29 15.00
4.00 0.86 -10.00
4.00 0.86 -10.00
4.00 0.86 -10.00
6.00 1.60 38.00
4.00 0.86 -10.00
4.00 0.86 -10.00
4.00 0.86 -10.00
4.00 0.86 -10.00
7.00 2.76 38.00
4.00 0.86 -10.00
4.00 0.86 -10.00
4.00 0.86 -10.00
6.00 1.60 60.00
4.00 0.86 -10.00
4.00 0.86 -10.00

4.00 0.86 -10.00
6.00 2.39 60.00
4.00 0.86 -10.00
4.00 0.86 -10.00
4.00 0.86 -10.00
4.00 0.86 -10.00
6.00 1.60 60.00
4.00 0.86 -10.00
4.00 0.86 -10.00
4.00 0.86 -10.00
7.00 2.40 60.00
4.00 0.86 -10.00
4.00 0.86 -10.00
4.00 0.86 -10.00
5.00 1.19 38.00
4.00 0.86 -10.00
4.00 0.86 -10.00
4.00 0.86 -10.00
4.00 0.86 -10.00
6.00 1.75 15.00
4.00 0.86 -10.00
4.00 0.86 -10.00
4.00 0.86 -10.00
6.00 1.75 15.00
4.00 0.86 -10.00
4.00 0.86 -10.00
4.00 0.86 -10.00
6.00 1.93 -8.00
4.00 0.86 -10.00
4.00 0.86 -10.00
4.00 0.86 -10.00
5.00 1.43 -8.00
4.00 0.86 -10.00
4.00 0.86 -10.00
4.00 0.86 -10.00
6.00 1.76 -30.00
4.00 0.86 -10.00
4.00 0.86 -10.00
4.00 0.86 -10.00
6.00 1.90 -33.00
4.00 0.86 -10.00
4.00 0.86 -10.00
4.00 0.86 -10.00
8.00 1.85 -33.00
4.00 0.86 -10.00
4.00 0.86 -10.00
4.00 0.86 -10.00
5.00 2.19 -30.00
4.00 0.86 -10.00
4.00 0.86 -10.00

4.00 0.86 -10.00
6.00 2.89 -8.00
4.00 0.86 -10.00
4.00 0.86 -10.00
4.00 0.86 -10.00
4.00 0.86 -10.00
8.00 3.91 -8.00
4.00 0.86 -10.00
4.00 0.86 -10.00
4.00 0.86 -10.00
8.00 2.65 -30.00
4.00 0.86 -10.00
4.00 0.86 -10.00
4.00 0.86 -10.00
5.00 0.97 -33.00
4.00 0.86 -10.00
4.00 0.86 -10.00
4.00 0.86 -10.00
4.00 0.86 -10.00
4.00 0.86 -10.00
8.00 2.16 -33.00
4.00 0.86 -10.00
4.00 0.86 -10.00
4.00 0.86 -10.00
7.00 1.13 -33.00
4.00 0.86 -10.00
4.00 0.86 -10.00
4.00 0.86 -10.00
4.00 0.86 -10.00
8.00 2.65 -30.00
4.00 0.86 -10.00
4.00 0.86 -10.00
4.00 0.86 -10.00
8.00 2.65 -30.00
4.00 0.86 -10.00
4.00 0.86 -10.00
4.00 0.86 -10.00
4.00 1.75 -30.00 J
4.00 0.86 -10.00 U
4.00 0.86 -10.00 L
4.00 0.86 -10.00
4.00 0.86 -10.00
5.00 1.91 -8.00
4.00 0.86 -10.00
4.00 0.86 -10.00
4.00 0.86 -10.00
4.00 0.86 -10.00
4.00 0.86 -10.00
4.00 0.86 -10.00
4.00 1.27 15.00
4.00 0.86 -10.00
4.00 0.86 -10.00
4.00 0.86 -10.00
4.00 0.86 -10.00

4.00 0.86 -10.00
 8.00 4.39 60.00
 4.00 0.86 -10.00
 4.00 0.86 -10.00
 6.00 1.20 60.00
 4.00 0.86 -10.00
 4.00 0.86 -10.00
 4.00 0.86 -10.00
 8.00 2.67 15.00
 4.00 0.86 -10.00
 4.00 0.86 -10.00
 8.00 2.96 -8.00
 4.00 0.86 -10.00
 4.00 0.86 -10.00
 8.00 3.10 -30.00
 4.00 0.86 -10.00
 4.00 0.86 -10.00
 8.00 1.01 -33.00
 4.00 0.86 -10.00
 4.00 0.86 -10.00
 4.00 0.86 -10.00
 4.00 0.86 -10.00
 8.00 1.85 -33.00
 4.00 0.86 -10.00
 4.00 0.86 -10.00
 8.00 3.09 -33.00
 4.00 0.86 -10.00
 4.00 0.86 -10.00
 8.00 3.91 -8.00
 4.00 0.86 -10.00
 4.00 0.86 -10.00
 4.00 0.86 -10.00
 8.00 3.91 -8.00
 4.00 0.86 -10.00
 4.00 0.86 -10.00
 8.00 2.67 15.00
 4.00 0.86 -10.00
 4.00 0.86 -10.00
 8.00 2.80 38.00
 4.00 0.86 -10.00
4.00 0.86 -10.00
 6.00 1.60 38.00 O
 4.00 0.86 -10.00 C
 4.00 0.86 -10.00 T
 4.00 0.86 -10.00
 5.00 1.70 15.00
 4.00 0.86 -10.00
 4.00 0.86 -10.00
 4.00 0.86 -10.00
 4.00 0.86 -10.00
 4.00 0.86 -10.00
 7.00 2.91 -8.00
 4.00 0.86 -10.00
 4.00 0.86 -10.00

4.00 0.86 -10.00
 6.00 1.76 -30.00
 4.00 0.86 -10.00
 4.00 0.86 -10.00
 4.00 0.86 -10.00
 4.00 0.86 -10.00
 6.00 1.76 -30.00
 4.00 0.86 -10.00
 4.00 0.86 -10.00
 4.00 0.86 -10.00
 6.00 1.26 -33.00
 4.00 0.86 -10.00
 4.00 0.86 -10.00
 4.00 0.86 -10.00
 8.00 1.01 -33.00
 4.00 0.86 -10.00
 4.00 0.86 -10.00
 4.00 0.86 -10.00
 4.00 0.86 -10.00
 8.00 2.47 -33.00
 4.00 0.86 -10.00
 4.00 0.86 -10.00
 4.00 0.86 -10.00
 4.00 0.86 -10.00
 8.00 1.85 -33.00
 4.00 0.86 -10.00
 4.00 0.86 -10.00
 4.00 0.86 -10.00
 6.00 1.26 -33.00
 4.00 0.86 -10.00
 4.00 0.86 -10.00
 4.00 0.86 -10.00
 6.00 2.64 -30.00
 4.00 0.86 -10.00
 4.00 0.86 -10.00
 4.00 0.86 -10.00
 4.00 0.86 -10.00
 6.00 1.93 -8.00
 4.00 0.86 -10.00
 4.00 0.86 -10.00
 4.00 0.86 -10.00

4.00 0.86 -10.00
 7.00 2.04 -8.00
 4.00 0.86 -10.00
 4.00 0.86 -10.00
 4.00 0.86 -10.00
 4.00 0.86 -10.00
 7.00 2.59 15.00
 4.00 0.86 -10.00
 4.00 0.86 -10.00
 4.00 0.86 -10.00
 4.00 0.86 -10.00
 8.00 1.60 38.00
 4.00 0.86 -10.00
 4.00 0.86 -10.00
 4.00 1.19 60.00
 4.00 0.86 -10.00
 4.00 0.86 -10.00
 4.00 0.86 -10.00
 8.00 2.40 38.00
 4.00 0.86 -10.00
 4.00 0.86 -10.00
 4.00 0.86 -10.00
 7.00 2.39 38.00
 4.00 0.86 -10.00
 4.00 0.86 -10.00
 4.00 0.86 -10.00
 7.00 2.00 60.00
 4.00 0.86 -10.00
 4.00 0.86 -10.00
 4.00 0.86 -10.00
 4.00 0.86 -10.00
 8.00 3.18 38.00
 4.00 0.86 -10.00
 4.00 0.86 -10.00
 4.00 0.86 -10.00
 4.00 0.86 -10.00
 8.00 4.35 38.00
 4.00 0.86 -10.00
 4.00 0.86 -10.00
 4.00 0.86 -10.00
 4.00 0.86 -10.00
 8.00 4.39 38.00
 4.00 0.86 -10.00

4.00	0.86	-10.00	
4.00	0.86	-10.00	
4.00	0.86	-10.00	
7.00	4.31	15.00	
4.00	0.86	-10.00	
4.00	0.86	-10.00	
4.00	0.86	-10.00	
4.00	0.86	-10.00	
<u>4.00</u>	<u>0.86</u>	<u>-10.00</u>	
5.00	1.70	15.00	N
4.00	0.86	-10.00	O
4.00	0.86	-10.00	V
4.00	0.86	-10.00	
4.00	0.86	-10.00	
6.00	2.36	38.00	
4.00	0.86	-10.00	
4.00	0.86	-10.00	
4.00	0.86	-10.00	
4.00	0.86	-10.00	
6.00	1.97	38.00	
4.00	0.86	-10.00	
4.00	0.86	-10.00	
4.00	0.86	-10.00	
4.00	0.86	-10.00	
4.00	0.86	-10.00	
7.00	2.00	60.00	
4.00	0.86	-10.00	
4.00	0.86	-10.00	
4.00	0.86	-10.00	
8.00	3.19	60.00	
4.00	0.86	-10.00	
4.00	0.86	-10.00	
4.00	0.86	-10.00	
8.00	7.20	60.00	
4.00	0.86	-10.00	
4.00	0.86	-10.00	
4.00	0.86	-10.00	
7.00	2.39	38.00	
4.00	0.86	-10.00	
4.00	0.86	-10.00	
4.00	0.86	-10.00	
4.00	0.86	-10.00	
4.00	0.86	-10.00	
8.00	2.67	15.00	
4.00	0.86	-10.00	
4.00	0.86	-10.00	
4.00	0.86	-10.00	
4.00	0.86	-10.00	
8.00	2.67	15.00	
4.00	0.86	-10.00	
4.00	0.86	-10.00	
4.00	0.86	-10.00	
4.00	0.86	-10.00	
8.00	2.23	15.00	
4.00	0.86	-10.00	
4.00	0.86	-10.00	
4.00	0.86	-10.00	
8.00	3.18	38.00	
4.00	0.86	-10.00	
4.00	0.86	-10.00	
4.00	0.86	-10.00	
4.00	0.86	-10.00	
8.00	3.18	38.00	
4.00	0.86	-10.00	
4.00	0.86	-10.00	
4.00	0.86	-10.00	
4.00	0.86	-10.00	
8.00	4.40	-8.00	
4.00	0.86	-10.00	
4.00	0.86	-10.00	
4.00	0.86	-10.00	
8.00	4.44	-30.00	
4.00	0.86	-10.00	
4.00	0.86	-10.00	
4.00	0.86	-10.00	
8.00	1.85	-33.00	
4.00	0.86	-10.00	
4.00	0.86	-10.00	
4.00	0.86	-10.00	
4.00	0.86	-10.00	
8.00	1.56	-33.00	
4.00	0.86	-10.00	
4.00	0.86	-10.00	
4.00	0.86	-10.00	
8.00	1.85	-33.00	
4.00	0.86	-10.00	
4.00	0.86	-10.00	
4.00	0.86	-10.00	
8.00	1.85	-33.00	
4.00	0.86	-10.00	
4.00	0.86	-10.00	
5.00	0.97	-33.00	
4.00	0.86	-10.00	
4.00	0.86	-10.00	
4.00	0.86	-10.00	
7.00	1.78	-30.00	
4.00	0.86	-10.00	
4.00	0.86	-10.00	
4.00	0.86	-10.00	
6.00	1.93	-8.00	
4.00	0.86	-10.00	
4.00	0.86	-10.00	
4.00	0.86	-10.00	
8.00	8.24	-8.00	
4.00	0.86	-10.00	
4.00	0.86	-10.00	
4.00	0.86	-10.00	
8.00	5.69	15.00	
4.00	0.86	-10.00	

4.00	0.86	-10.00	
4.00	0.86	-10.00	
4.00	0.86	-10.00	
8.00	3.07	15.00	
4.00	0.86	-10.00	
4.00	0.86	-10.00	
4.00	0.86	-10.00	
8.00	3.95	38.00	
4.00	0.86	-10.00	
4.00	0.86	-10.00	
4.00	0.86	-10.00	
8.00	3.99	38.00	
4.00	0.86	-10.00	
4.00	0.86	-10.00	
8.00	3.97	38.00	
4.00	0.86	-10.00	
4.00	0.86	-10.00	
8.00	6.37	38.00	
4.00	0.86	-10.00	
4.00	0.86	-10.00	
<u>4.00</u>	<u>0.86</u>	<u>-10.00</u>	
-0.00	0.00	0.00	D
-0.00	0.00	0.00	E
-0.00	0.00	0.00	C
.			
.			
(a total of 120			
"zero" lines from			
Dec 1 to Dec 30)			
.			
.			
-0.00	0.00	0.00	
-0.00	0.00	0.00	
-0.00	0.00	0.00	

OUTPT Files

File OUTPT_CAL resulting from the calibration calculation:

RUN: LAKEVIEW PARK CASE STUDY, MAY-JUNE 1989, CALIBRATION

INITIAL SHORELINE

151.2	154.2	157.2	162.2	173.2	194.2	212.2	215.2	220.2	220.2
218.2	215.2	212.2	210.2	210.2	212.2	215.2	226.2	233.2	244.2
255.2	263.2	273.2	279.2	281.2	284.2	279.2	273.2	263.2	257.2
255.2	257.2	263.2	273.2	279.2	287.2	295.2	295.2	295.2	295.2
297.2	292.2	287.2	281.2	279.2	273.2	271.2	263.2	252.2	

LAST TIME STEP. WAVES ORIGINATING FROM ENERGY WINDOW NO. 1

BREAKING WAVE HEIGHT

0.91	0.34	0.29	0.24	0.19	0.15	0.12	0.09	0.07	0.06
0.05	0.04	0.03	0.	0.	0.	0.	0.	0.	0.
0.	0.	0.	0.	0.	0.	0.	0.	0.	0.
0.	0.	0.	0.	0.	0.	0.	0.	0.	0.
0.	0.	0.	0.	0.	0.	0.	0.	0.	

BREAKING WAVE ANGLE TO X-AXIS

11.31	11.27	18.12	22.58	24.79	25.87	23.82	22.38	16.36	10.18
7.83	7.57	7.21	0.	0.	0.	0.	0.	0.	0.
0.	0.	0.	0.	0.	0.	0.	0.	0.	0.
0.	0.	0.	0.	0.	0.	0.	0.	0.	0.
0.	0.	0.	0.	0.	0.	0.	0.	0.	

LAST TIME STEP. WAVES ORIGINATING FROM ENERGY WINDOW NO. 2

BREAKING WAVE HEIGHT

0.	0.53	0.53	0.53	0.53	0.53	0.53	0.53	0.54	0.54
0.54	0.	0.	0.	0.	0.	0.	0.	0.	0.
0.	0.	0.	0.	0.	0.	0.	0.	0.	0.
0.	0.	0.	0.	0.	0.	0.	0.	0.	0.
0.	0.	0.	0.	0.	0.	0.	0.	0.	

BREAKING WAVE ANGLE TO X-AXIS

0.	11.74	13.97	15.22	15.59	15.58	13.22	11.92	9.14	6.50
5.26	0.	0.	0.	0.	0.	0.	0.	0.	0.
0.	0.	0.	0.	0.	0.	0.	0.	0.	0.
0.	0.	0.	0.	0.	0.	0.	0.	0.	0.
0.	0.	0.	0.	0.	0.	0.	0.	0.	

LAST TIME STEP. WAVES ORIGINATING FROM ENERGY WINDOW NO. 3

BREAKING WAVE HEIGHT

0.09	0.11	0.12	0.13	0.15	0.16	0.19	0.22	0.27	0.32
0.37	0.94	0.96	0.96	0.94	0.89	0.59	0.50	0.41	0.33
0.25	0.18	0.14	0.10	0.09	0.07	0.06	0.06	0.05	0.04
0.04	0.04	0.	0.	0.	0.	0.	0.	0.	0.
0.	0.	0.	0.	0.	0.	0.	0.	0.	

BREAKING WAVE ANGLE TO X-AXIS

13.92	8.96	15.34	18.77	19.63	19.38	16.12	13.99	8.15	3.15
2.16	4.93	4.70	4.55	4.46	4.46	4.37	11.15	16.20	18.91
22.57	23.76	23.67	5.66	-2.96	-6.73	-1.32	-1.80	-1.30	-0.45
0.71	2.27	0.	0.	0.	0.	0.	0.	0.	0.
0.	0.	0.	0.	0.	0.	0.	0.	0.	0.

LAST TIME STEP. WAVES ORIGINATING FROM ENERGY WINDOW NO. 4

BREAKING WAVE HEIGHT

0.	0.	0.	0.	0.	0.	0.	0.	0.	0.
0.	0.	0.	0.	0.	0.	0.24	0.24	0.24	0.24
0.24	0.24	0.24	0.24	0.24	0.24	0.	0.	0.	0.
0.	0.	0.	0.	0.	0.	0.	0.	0.	0.
0.	0.	0.	0.	0.	0.	0.	0.	0.	0.

BREAKING WAVE ANGLE TO X-AXIS

0.	0.	0.	0.	0.	0.	0.	0.	0.	0.
0.	0.	0.	0.	0.	0.	6.52	10.22	12.54	13.17
14.49	14.17	13.11	1.29	-4.19	-6.64	0.	0.	0.	0.
0.	0.	0.	0.	0.	0.	0.	0.	0.	0.
0.	0.	0.	0.	0.	0.	0.	0.	0.	0.

LAST TIME STEP. WAVES ORIGINATING FROM ENERGY WINDOW NO. 5

BREAKING WAVE HEIGHT

0.06	0.06	0.06	0.06	0.06	0.06	0.06	0.06	0.07	0.07
0.08	0.08	0.09	0.10	0.11	0.12	0.13	0.15	0.16	0.18
0.21	0.24	0.28	0.34	0.43	0.53	0.87	0.95	1.00	1.03
1.03	1.01	0.98	0.93	0.53	0.44	0.35	0.27	0.20	0.15
0.11	0.09	0.07	0.06	0.05	0.05	0.04	0.04	0.04	0.04

BREAKING WAVE ANGLE TO X-AXIS

14.70	9.55	16.47	20.31	21.44	21.38	17.93	15.57	8.53	1.78
-0.73	-1.06	-1.47	-1.46	-1.04	-0.39	2.04	8.20	11.97	12.93
15.13	14.76	13.41	-4.08	-10.56	-11.93	-1.98	-2.16	-2.11	-1.88
-1.46	-0.90	-0.21	0.57	6.77	13.78	17.17	18.57	21.11	19.79
13.01	-1.31	-6.40	-9.64	-8.02	-8.47	-8.29	-7.88	-6.83	

LAST TIME STEP. WAVES ORIGINATING FROM ENERGY WINDOW NO. 6

BREAKING WAVE HEIGHT

0.	0.	0.	0.	0.	0.	0.	0.	0.	0.
0.	0.	0.	0.	0.	0.	0.	0.	0.	0.
0.	0.	0.	0.	0.	0.	0.	0.	0.	0.
0.	0.	0.	0.	0.33	0.33	0.33	0.33	0.33	0.33
0.33	0.33	0.33	0.34	0.	0.	0.	0.	0.	0.

BREAKING WAVE ANGLE TO X-AXIS

0.	0.	0.	0.	0.	0.	0.	0.	0.	0.
0.	0.	0.	0.	0.	0.	0.	0.	0.	0.
0.	0.	0.	0.	0.	0.	0.	0.	0.	0.
0.	0.	0.	0.	5.78	9.26	10.30	10.03	10.43	8.51
3.90	-4.07	-7.20	-9.36	0.	0.	0.	0.	0.	

LAST TIME STEP. WAVES ORIGINATING FROM ENERGY WINDOW NO. 7

BREAKING WAVE HEIGHT

0.03	0.03	0.03	0.03	0.03	0.03	0.03	0.03	0.03	0.03
0.03	0.04	0.04	0.04	0.04	0.04	0.04	0.04	0.04	0.04
0.04	0.04	0.04	0.04	0.05	0.05	0.05	0.06	0.06	0.07
0.08	0.08	0.09	0.10	0.11	0.12	0.14	0.15	0.17	0.20
0.24	0.31	0.39	0.50	0.93	1.00	1.05	1.08	1.10	

BREAKING WAVE ANGLE TO X-AXIS

15.85	10.67	17.76	21.71	22.90	22.89	19.44	17.09	9.96	3.09
0.58	0.32	-0.02	0.09	0.64	1.43	4.15	10.94	15.24	16.54
19.28	19.22	18.05	-2.71	-11.86	-15.63	-10.07	-10.50	-9.97	-9.11
-7.96	-6.45	-4.50	-3.00	5.10	11.39	13.07	12.51	13.56	10.71
3.06	-10.01	-13.23	-14.05	-8.71	-8.59	-8.48	-8.42	-8.38	

GROSS TRANSPORT VOLUME (YARDS3) FOR CALCULATED PART OF YEAR 1

36310	45967	48287	49323	47485	44151	40880	35693	31864	30314
28894	28696	27242	24888	23349	21664	19094	17224	16488	16620
17036	17966	18560	17964	16192	15805	19627	20727	22050	22664
23225	23226	24940	25258	22169	21343	21325	21280	21442	20334
18728	16679	16973	17843	21430	22789	22271	22319	19340	1501

NET TRANSPORT VOLUME (YARDS3) FOR CALCULATED PART OF YEAR 1

4228	4780	5253	5570	5729	5850	6156	6621	6938	7226
7446	7576	7596	7511	7340	7122	6893	6648	6495	6297
6130	5961	5725	5480	5354	5348	5525	5647	5694	5573
5361	5135	4967	4924	5078	5253	5420	5557	5490	5203
4727	4193	3604	3012	2429	1924	1411	976	480	-154

TRANSPORT VOLUME TO THE LEFT (YARDS3) FOR CALCULATED PART OF YEAR 1

-16040	-20592	-21516	-21876	-20877	-19149	-17368	-14436	-12461	-11543
-10724	-10559	-9822	-8689	-8001	-7271	-6098	-5287	-4996	-5161
-5478	-6002	-6417	-6241	-5419	-5228	-7051	-7540	-8178	-8544
-8933	-9045	-9986	-10166	-8545	-8044	-7952	-7861	-7975	-7565
-7000	-6243	-6684	-7415	-9500	-10432	-10429	-10670	-9429	-828

TRANSPORT VOLUME TO THE RIGHT (YARDS3) FOR CALCULATED PART OF YEAR 1

20269	25373	26770	27446	26607	25001	23510	21253	19400	18768
18169	18136	17419	16199	15348	14393	12995	11936	11492	11458
11608	11964	12144	11722	10773	10577	12576	13187	13872	14119
14293	14180	14953	15090	13623	13298	13373	13419	13466	12768
11727	10438	10288	10427	11929	12356	11841	11648	9910	673

OUTPUT OF BREAKING WAVE STATISTICS FOR SELECTED LOCATIONS
 N.B. WAVE DIFFRACTION IS NOT ACCOUNTED FOR!

GRID CELL NUMBERS

1	2	3	4	5	6	7	8	9	10
11	12	13	14	15	16	17	18	19	20
21	22	23	24	25	26	27	28	29	30
31	32	33	34	35	36	37	38	39	40
41	42	43	44	45	46	47	48	49	

AVERAGE UNDIFFRACTED BREAKING WAVE HEIGHT

1.0	1.0	1.0	1.0	1.0	1.0	1.0	1.0	1.0	1.0
1.0	1.0	1.0	1.0	1.0	1.0	1.0	1.0	1.0	1.0
1.0	1.0	1.0	1.0	1.1	1.1	1.1	1.1	1.1	1.1
1.1	1.1	1.1	1.0	1.0	1.0	1.0	1.0	1.0	1.0
1.1	1.1	1.1	1.1	1.1	1.1	1.1	1.1	1.1	

AVERAGE UNDIFFRACTED BREAKING WAVE ANGLE TO SHORELINE (DEG)

-5.7	-4.4	-7.4	-8.7	-9.6	-10.4	-9.5	-7.0	-4.2	0.7
2.7	2.4	2.1	1.6	0.4	-1.2	-3.9	-7.5	-9.4	-11.1
-13.9	-13.7	-11.1	-2.0	6.0	11.3	6.1	5.3	4.6	3.1
2.1	1.0	-1.6	-2.9	-6.7	-9.7	-11.0	-12.9	-13.6	-11.7
-8.2	-0.3	7.6	9.4	4.5	3.9	3.0	1.8	1.0	

AVERAGE LONGSHORE TRANSPORT RATE WITHOUT DIFFRACTION (FT3/SEC)

-0.034	-0.033	-0.064	-0.077	-0.087	-0.102	-0.089	-0.042	-0.017	0.047
0.075	0.088	0.086	0.077	0.054	0.031	-0.009	-0.055	-0.085	-1.010
0.148	-0.150	-0.117	0.009	0.130	0.179	0.142	0.127	0.117	0.086
0.072	0.053	0.016	-0.006	-0.047	-0.090	-0.107	-0.137	-0.146	-0.114
-0.074	0.038	0.137	0.162	0.113	0.101	0.084	0.059	0.045	0.0

LONGSHORE TRANSPORT (FT3/SEC)

0.	-0.002	-0.004	-0.005	-0.006	-0.006	-0.005	-0.005	-0.003	-0.001
0.000	0.001	0.001	0.001	0.000	-0.002	-0.003	-0.002	-0.001	-0.001
-0.01	-0.001	-0.002	-0.001	-0.001	0.000	0.005	0.007	0.007	0.006
0.04	0.002	-0.002	-0.003	-0.003	-0.003	-0.002	-0.002	-0.002	-0.002
-0.02	0.000	0.000	0.001	0.006	0.009	0.010	0.009	0.006	0.0

CALCULATED SHORELINE

126.4	132.9	143.0	155.0	167.8	180.4	191.3	201.0	207.2	210.4
212.4	214.3	216.0	217.9	220.0	222.5	226.2	233.1	242.1	251.7
262.8	273.8	284.2	284.9	281.5	276.3	273.7	271.1	268.7	266.7
265.4	264.8	265.1	266.3	271.4	279.7	289.0	298.2	308.1	316.6
321.2	318.7	313.8	307.4	301.9	296.2	290.7	285.5	280.8	

CALCULATED SEAWARDEST SHORELINE POSITION

151.2	159.3	171.2	189.3	211.3	236.3	271.6	273.8	237.5	236.5
227.9	221.8	222.2	223.4	225.2	228.5	234.3	241.2	250.3	261.3
276.0	287.8	298.5	303.1	296.1	286.2	279.2	273.8	269.9	267.0
265.4	266.1	267.9	273.2	279.2	287.2	295.2	301.2	315.1	326.0
344.7	332.5	328.8	320.0	310.7	303.5	298.5	295.7	295.6	

CALCULATED LANDWARDMOST SHORELINE POSITION

91.9	106.4	122.6	139.9	152.5	167.9	179.2	186.7	195.6	197.2
206.0	207.5	208.4	207.2	208.1	211.4	215.2	214.5	224.6	237.5
253.6	263.2	272.5	279.2	278.7	271.1	264.7	258.8	251.4	247.0
241.2	243.9	247.4	243.8	250.9	259.8	271.1	284.9	295.2	295.2
296.5	292.2	287.2	281.2	278.4	273.1	267.4	261.7	252.2	

CALCULATED REPRESENTATIVE OFFSHORE CONTOUR

1110.6	1119.7	1128.7	1137.8	1146.9	1155.9	1163.8	1171.1	1177.8	1184.1
1189.8	1195.2	1200.5	1205.6	1210.6	1215.6	1220.5	1225.5	1230.3	1235.1
1239.5	1243.6	1247.1	1249.9	1251.9	1253.5	1254.7	1255.6	1256.5	1257.5
1258.7	1260.3	1262.3	1264.7	1267.5	1270.6	1273.9	1277.0	1279.8	1281.8
1283.0	1283.4	1282.9	1281.6	1278.3	1274.9	1271.6	1268.3	1265.0	

CALIBRATION/VERIFICATION ERROR = 4.03645

File OUTPT_VER resulting from the verification calculation (Year 1 refers to the period 9 Oct 1978 through 8 Oct 1979, Year 2 refers to the period 9 Oct 1979 till the end of the simulation period):

RUN: LAKEVIEW PARK CASE STUDY, MAY-JUNE 1989, VERIFICATION

INITIAL SHORELINE

131.4	139.4	148.4	158.4	168.4	183.4	191.4	202.4	208.4	208.4
207.4	208.4	209.4	213.4	217.4	216.4	219.4	227.4	238.4	249.4
264.4	277.4	283.4	279.4	275.4	272.4	273.4	278.4	275.4	273.4
272.4	269.4	270.4	272.4	277.4	282.4	289.4	299.4	310.4	320.4
325.4	318.4	307.4	301.4	296.4	294.4	285.4	281.4	276.4	

GROSS TRANSPORT VOLUME (YARDS3) FOR CALCULATED PART OF YEAR 1

21131	44696	54797	59264	61894	60843	58831	54605	48872	45301
42159	40481	38028	34870	31417	28324	25605	21766	20514	20193
21028	22150	22910	22744	21335	21105	27188	28573	29633	30039
30478	30148	32153	32072	28076	26760	26519	26352	26282	24090
21536	19155	20025	22020	28047	29819	29210	29023	29061	4254

NET TRANSPORT VOLUME (YARDS3) FOR CALCULATED PART OF YEAR 1

-1540	-563	444	1441	2373	3190	3987	4643	5244	5709
6036	6235	6370	6445	6528	6618	6600	6559	6529	6532
6542	6614	6698	6635	6404	6174	5979	5846	5871	5872
5862	5853	5785	5728	5689	5643	5517	5317	5100	4893
4707	4527	4241	3826	3437	3061	2769	2402	2063	1719

TRANSPORT VOLUME TO THE LEFT (YARDS3) FOR CALCULATED PART OF YEAR 1

-11335	-22629	-27175	-28911	-29759	-28826	-27422	-24981	-21813	-19795
-19061	-17123	-15828	-14213	-12439	-10852	-9502	-7600	-6992	-6829
-7243	-7768	-8106	-8054	-7465	-7464	-10604	-11361	-11882	-12083
-12308	-12146	-13184	-13172	-11194	-10557	-10500	-10517	-10591	-9598
-8414	-7313	-7891	-9096	-12304	-13378	-13219	-13308	-13493	-1267

TRANSPORT VOLUME TO THE RIGHT (YARDS3) FOR CALCULATED PART OF YEAR 1

9795	22066	27620	30353	32133	32016	31409	29622	27055	25501
24096	23357	22199	20657	18976	17471	16102	14165	13522	13363
13785	14381	14804	14689	13869	13639	16584	17210	17752	17956
18170	18000	18968	18899	16881	16202	16019	15835	15691	14491
13120	11841	12133	12923	15742	16440	15990	15714	15566	2987

LAST TIME STEP. WAVES ORIGINATING FROM ENERGY WINDOW NO. 1

BREAKING WAVE HEIGHT

0.99	0.38	0.34	0.29	0.24	0.19	0.15	0.12	0.09	0.07
0.06	0.05	0.04	0.04	0.	0.	0.	0.	0.	0.
0.	0.	0.	0.	0.	0.	0.	0.	0.	0.
0.	0.	0.	0.	0.	0.	0.	0.	0.	0.
0.	0.	0.	0.	0.	0.	0.	0.	0.	0.

BREAKING WAVE ANGLE TO X-AXIS

14.24	7.68	14.51	21.57	27.32	31.06	31.41	32.26	32.86	31.58
6.25	7.10	6.42	7.51	0.	0.	0.	0.	0.	0.
0.	0.	0.	0.	0.	0.	0.	0.	0.	0.
0.	0.	0.	0.	0.	0.	0.	0.	0.	0.
0.	0.	0.	0.	0.	0.	0.	0.	0.	0.

LAST TIME STEP. WAVES ORIGINATING FROM ENERGY WINDOW NO. 2

BREAKING WAVE HEIGHT

0.	0.56	0.56	0.56	0.56	0.56	0.57	0.57	0.57	0.58
0.58	0.	0.	0.	0.	0.	0.	0.	0.	0.
0.	0.	0.	0.	0.	0.	0.	0.	0.	0.
0.	0.	0.	0.	0.	0.	0.	0.	0.	0.
0.	0.	0.	0.	0.	0.	0.	0.	0.	0.

BREAKING WAVE ANGLE TO X-AXIS

0.	12.64	14.76	16.92	18.58	19.51	18.44	17.98	17.45	16.30
7.88	0.	0.	0.	0.	0.	0.	0.	0.	0.
0.	0.	0.	0.	0.	0.	0.	0.	0.	0.
0.	0.	0.	0.	0.	0.	0.	0.	0.	0.
0.	0.	0.	0.	0.	0.	0.	0.	0.	0.

LAST TIME STEP. WAVES ORIGINATING FROM ENERGY WINDOW NO. 3

BREAKING WAVE HEIGHT

0.11	0.12	0.14	0.15	0.17	0.19	0.21	0.24	0.28	0.33
0.38	0.99	1.02	1.03	1.01	0.97	0.91	0.56	0.47	0.37
0.28	0.20	0.15	0.11	0.09	0.08	0.07	0.06	0.06	0.05
0.05	0.04	0.04	0.03	0.	0.	0.	0.	0.	0.
0.	0.	0.	0.	0.	0.	0.	0.	0.	0.

BREAKING WAVE ANGLE TO X-AXIS

17.81	4.73	11.34	17.96	22.89	25.45	24.38	24.07	23.77	22.04
0.66	8.99	8.69	8.47	8.30	8.34	8.42	15.14	18.77	22.86
25.48	28.66	28.25	11.70	-2.74	-15.69	-7.82	-8.11	-6.57	-4.74
-2.46	0.61	5.05	10.69	0.	0.	0.	0.	0.	0.
0.	0.	0.	0.	0.	0.	0.	0.	0.	0.

LAST TIME STEP. WAVES ORIGINATING FROM ENERGY WINDOW NO. 4

BREAKING WAVE HEIGHT

0.	0.	0.	0.	0.	0.	0.	0.	0.	0.
0.	0.	0.	0.	0.	0.	0.	0.26	0.26	0.26
0.26	0.26	0.26	0.27	0.27	0.27	0.	0.	0.	0.
0.	0.	0.	0.	0.	0.	0.	0.	0.	0.
0.	0.	0.	0.	0.	0.	0.	0.	0.	0.

BREAKING WAVE ANGLE TO X-AXIS

0.	0.	0.	0.	0.	0.	0.	0.	0.	0.
0.	0.	0.	0.	0.	0.	0.	14.50	15.42	16.62
16.83	17.51	15.89	4.85	-3.97	-11.59	0.	0.	0.	0.
0.	0.	0.	0.	0.	0.	0.	0.	0.	0.
0.	0.	0.	0.	0.	0.	0.	0.	0.	0.

LAST TIME STEP. WAVES ORIGINATING FROM ENERGY WINDOW NO. 5

BREAKING WAVE HEIGHT

0.07	0.07	0.08	0.08	0.08	0.08	0.08	0.08	0.08	0.08
0.09	0.09	0.10	0.11	0.12	0.13	0.15	0.16	0.18	0.20
0.22	0.25	0.29	0.35	0.45	0.57	0.96	1.05	1.11	1.13
1.14	1.12	1.08	1.02	0.59	0.49	0.39	0.30	0.21	0.15
0.11	0.08	0.06	0.06	0.05	0.05	0.04	0.04	0.04	0.04

BREAKING WAVE ANGLE TO X-AXIS

18.52	4.66	11.79	19.06	24.60	27.65	26.71	26.59	26.41	24.31
-2.88	-2.09	-2.82	-1.80	0.68	5.73	7.99	13.26	15.07	17.40
18.07	19.61	17.52	0.66	-11.02	-19.07	-2.88	-2.85	-2.60	-2.18
-1.45	-0.44	0.77	2.20	13.06	16.14	21.65	25.24	26.94	25.83
21.25	12.85	1.31	-20.76	-15.67	-15.72	-15.13	-14.26	-11.65	

LAST TIME STEP. WAVES ORIGINATING FROM ENERGY WINDOW NO. 6

BREAKING WAVE HEIGHT

0.	0.	0.	0.	0.	0.	0.	0.	0.	0.
0.	0.	0.	0.	0.	0.	0.	0.	0.	0.
0.	0.	0.	0.	0.	0.	0.	0.	0.	0.
0.	0.	0.	0.	0.36	0.36	0.36	0.36	0.36	0.36
0.36	0.37	0.37	0.37	0.	0.	0.	0.	0.	0.

BREAKING WAVE ANGLE TO X-AXIS

0.	0.	0.	0.	0.	0.	0.	0.	0.	0.
0.	0.	0.	0.	0.	0.	0.	0.	0.	0.
0.	0.	0.	0.	0.	0.	0.	0.	0.	0.
0.	0.	0.	0.	10.67	11.78	14.07	14.94	14.57	12.37
8.57	3.21	-3.25	-14.21	0.	0.	0.	0.	0.	0.

LAST TIME STEP. WAVES ORIGINATING FROM ENERGY WINDOW NO. 7

BREAKING WAVE HEIGHT

0.04	0.04	0.04	0.04	0.04	0.04	0.04	0.04	0.04	0.04
0.04	0.04	0.04	0.04	0.04	0.04	0.05	0.05	0.05	0.05
0.05	0.05	0.05	0.05	0.05	0.05	0.06	0.06	0.07	0.08
0.09	0.09	0.10	0.12	0.13	0.14	0.15	0.16	0.18	0.20
0.23	0.29	0.38	0.51	1.02	1.11	1.16	1.19	1.21	

BREAKING WAVE ANGLE TO X-AXIS

19.89	5.78	13.15	20.65	26.36	29.51	28.62	28.55	28.43	26.36
-1.61	-0.70	-1.38	-0.21	2.53	8.05	10.64	16.52	18.73	21.58
22.69	24.83	22.99	3.41	-12.08	-24.99	-17.10	-17.30	-15.72	-13.89
-11.65	-8.67	-4.41	1.00	13.25	14.37	18.42	20.06	19.70	16.62
10.60	1.95	-7.74	-23.04	-10.70	-10.27	-10.22	-10.22	-10.22	

GROSS TRANSPORT VOLUME (YARDS3) FOR CALCULATED PART OF YEAR 2

4840	12749	12402	15443	17352	15912	14307	14700	12777	9941
8875	8667	8191	7630	7159	6720	6307	5651	5320	5186
5363	5533	5344	5148	4766	4335	5060	5185	5354	5579
5891	6100	7276	7359	6255	6262	6488	6476	6418	5628
4698	4343	4332	4341	4895	4758	4267	4442	4225	423

NET TRANSPORT VOLUME (YARDS3) FOR CALCULATED PART OF YEAR 2

3343	3431	3566	3735	3929	4128	4306	4442	4518	4505
4300	4176	4102	4082	4101	4134	4127	4058	3939	3789
3601	3397	3153	2898	2644	2376	2228	2166	2187	2277
2423	2612	2826	3037	3206	3283	3328	3325	3260	3128
2932	2646	2217	1699	1293	969	722	548	443	389

TRANSPORT VOLUME TO THE LEFT (YARDS3) FOR CALCULATED PART OF YEAR 2

-748	-4658	-4417	-5854	-6711	-5891	-5000	-5129	-4129	-2718
-2286	-2245	-2044	-1774	-1528	-1293	-1090	-795	-691	-698
-881	-1068	-1095	-1124	-1060	-979	-1416	-1509	-1583	-1651
-1734	-1743	-2225	-2160	-1524	-1489	-1580	-1575	-1578	-1250
-883	-848	-1057	-1320	-1800	-1894	-1772	-1946	-1890	-16

TRANSPORT VOLUME TO THE RIGHT (YARDS3) FOR CALCULATED PART OF YEAR 2

4092	8090	7984	9589	10640	10020	9307	9571	8648	7223
6589	6422	6146	5856	5630	5427	5217	4855	4629	4488
4482	4465	4248	4023	3705	3356	3644	3675	3771	3928
4157	4356	5051	5198	4731	4773	4908	4900	4839	4378
3815	3494	3275	3020	3094	2863	2494	2495	2334	406

OUTPUT OF BREAKING WAVE STATISTICS FOR SELECTED LOCATIONS

N.B. WAVE DIFFRACTION IS NOT ACCOUNTED FOR!

GRID CELL NUMBERS

1	2	3	4	5	6	7	8	9	10
11	12	13	14	15	16	17	18	19	20
21	22	23	24	25	26	27	28	29	30
31	32	33	34	35	36	37	38	39	40
41	42	43	44	45	46	47	48	49	

AVERAGE UNDIFFRACTED BREAKING WAVE HEIGHT

1.2	1.2	1.2	1.2	1.2	1.2	1.2	1.2	1.2	1.2
1.2	1.2	1.2	1.2	1.2	1.2	1.2	1.2	1.2	1.2
1.2	1.2	1.2	1.2	1.2	1.2	1.2	1.2	1.2	1.2
1.2	1.2	1.2	1.2	1.2	1.2	1.2	1.2	1.2	1.2
1.2	1.2	1.2	1.2	1.2	1.2	1.2	1.2	1.2	1.2

AVERAGE UNDIFFRACTED BREAKING WAVE ANGLE TO SHORELINE (DEG)

-6.9	-3.9	-6.4	-8.4	-10.3	-11.3	-11.8	-10.7	-8.7	-3.1
-0.1	1.7	2.1	1.7	0.5	-1.1	-2.4	-7.6	-10.1	-12.0
-15.3	-15.6	-13.3	-3.4	6.3	13.3	6.5	5.9	5.1	3.6
2.6	1.3	-1.3	-2.9	-7.5	-10.5	-12.2	-14.9	-15.6	-14.2
-8.4	0.2	8.2	11.2	5.3	4.5	3.6	2.2	1.0	

AVERAGE LONGSHORE TRANSPORT RATE WITHOUT DIFFRACTION (FT3/SEC)

-0.051	-0.035	-0.060	-0.091	-0.106	-0.126	-0.135	-0.117	-0.064	-0.003
0.051	0.081	0.112	0.107	0.082	0.052	0.023	-0.051	-0.095	-0.133
-0.184	-0.196	-0.162	0.003	0.168	0.240	0.188	0.173	0.161	0.122
0.105	0.078	0.034	-0.002	-0.057	-0.109	-0.136	-0.184	-0.197	-0.172
-0.079	0.064	0.178	0.222	0.159	0.141	0.122	0.089	0.057	0.0

LONGSHORE TRANSPORT (FT3/SEC)

0.0	0.001	-0.002	-0.005	-0.007	-0.008	-0.009	-0.009	-0.010	-0.010
0.003	0.012	0.014	0.011	0.003	-0.009	-0.012	-0.004	-0.002	-0.002
-0.002	-0.002	-0.002	-0.002	-0.001	0.002	0.020	0.025	0.025	0.022
0.017	0.010	-0.001	-0.012	-0.006	-0.004	-0.003	-0.003	-0.003	-0.003
-0.003	-0.002	-0.001	0.003	0.022	0.028	0.031	0.030	0.020	0.0

CALCULATED SHORELINE

83.5	88.0	96.0	107.8	122.7	139.6	155.8	172.0	188.1	202.9
204.1	205.6	206.9	208.8	211.9	217.5	224.3	234.1	245.0	257.4
270.4	284.5	297.7	301.2	297.7	287.9	282.1	276.3	271.3	267.3
264.3	262.8	263.4	266.6	276.0	286.1	298.5	312.1	325.6	337.6
346.3	350.6	349.3	337.2	327.9	318.6	309.7	301.3	294.3	

CALCULATED SEAWARDMOST SHORELINE POSITION

140.1	146.1	187.5	163.7	212.5	194.2	243.4	251.6	267.4	248.6
243.1	233.7	226.1	226.5	228.5	233.1	238.4	244.5	252.0	264.4
278.9	294.9	308.9	311.3	306.4	295.1	287.1	281.7	277.6	274.5
273.3	274.0	276.1	280.2	285.6	293.4	302.5	315.0	332.9	361.6
357.9	352.2	349.7	339.5	328.7	321.6	318.0	316.0	316.1	

CALCULATED LANDWARDMOST SHORELINE POSITION

22.5	31.0	30.6	33.2	70.1	41.0	94.9	136.9	177.7	187.8
191.7	194.2	196.3	198.3	200.6	208.2	213.3	216.4	224.1	238.0
253.4	267.9	279.4	279.4	275.4	272.4	269.5	264.8	256.2	250.7
244.6	247.4	248.8	247.6	255.9	266.8	280.9	295.2	308.5	315.2
319.0	316.7	307.4	299.4	293.8	287.6	281.7	276.0	268.3	

CALCULATED REPRESENTATIVE OFFSHORE CONTOUR

1067.8	1079.1	1090.5	1101.8	1113.1	1124.5	1135.1	1145.2	1154.9	1164.1
1172.8	1181.2	1189.2	1197.1	1204.7	1212.2	1219.4	1226.3	1232.8	1239.0
1244.6	1249.7	1253.8	1257.0	1259.2	1260.5	1261.3	1261.8	1262.3	1263.1
1264.3	1266.1	1268.7	1272.2	1276.3	1281.1	1286.1	1291.1	1295.7	1299.2
1301.7	1302.8	1302.7	1301.3	1296.7	1292.1	1287.6	1283.0	1278.5	

CALIBRATION/VERIFICATION ERROR = 4.06798

APPENDIX E: NOTATION

This appendix contains separate lists for mathematical notation and the names of variables in the computer program that appear in the input START file and elsewhere. Length units are given as meters (m), but "feet" (ft) may be substituted if American customary units are selected in the modeling.

Mathematical Notation

a_1	Longshore sand transport parameter (contains K_1 ; see below)
a_2	Longshore sand transport parameter (contains K_2 ; see below)
A	Bottom profile shape parameter, $m^{1/3}$
b	Subscript denoting condition at wave breaking
B'	Composite of variables in the double-sweep algorithm (sec/m^2)
C	Wave phase speed, m/sec
C_g	Wave group speed, m/sec
C_{gb}	Wave group speed at breaking, m/sec
D	Water depth, m
d_{50}	Median sand grain size, mm
D_b	Water depth at wave breaking, m
D_B	Average berm height, m
D_C	Depth of closure, m
D_G	Water depth at groin tip, m
D_{LT}	Depth of active longshore transport, m
D_{LT0}	Maximum depth of longshore transport, m
E_i	Double sweep recurrence coefficient
F	Total fraction of sand passing over, around, or through a shore-connected structure (groin or jetty)
F_i	Double sweep recurrence coefficient, m^2/sec
g	Acceleration due to gravity, m/sec^2
H	Wave height, m
H_2	Breaking wave height at arbitrary point "Point 2," m
H_o	Deepwater wave height, m
H_b	Breaking wave height, m

H'_b	Breaking wave height without diffraction, m
H_{ref}	Wave height at the reference depth, m
H_{rf}	Wave height at reference line, m
i	Subscript denoting grid cell number; also, arbitrary counter
K_1	Longshore transport rate calibration parameter; also K1
K_2	Longshore transport rate calibration parameter; also K2
K_D	Diffraction coefficient for combined wave diffraction
K_{DL}	Diffraction coefficient for diffracting source on left
K_{DR}	Diffraction coefficient for diffracting source on right
K_{DT}	Wave diffraction coefficient for a transmissive structure
K_R	Refraction coefficient
K_S	Shoaling coefficient
K_T	Wave transmission coefficient for a single structure
L	Wavelength, m
L_b	Wavelength at breakpoint, m
L_o	Wavelength in deep water, m
M	Number of independent wave components
N	Number of calculation grid cells; also NN
p	Sediment porosity
q	Cross-shore sand transport rate, $m^3/sec/m$
q_o	Cross-shore sand transport rate from offshore, $m^3/sec/m$
q_s	Cross-shore sand transport rate from the shore, $m^3/sec/m$
Q	Longshore sand transport rate, m^3/sec
Q_g	Gross longshore sand transport rate, m^3/sec
Q_G	Longshore sand transport rate at a groin, m^3/sec
Q_{lt}	Longshore sand transport to the left, m^3/sec
Q_n	Net longshore sand transport rate, m^3/sec
Q_{rt}	Longshore sand transport to the right, m^3/sec
R_{KT}	Ratio of smaller valued to larger valued transmission coefficients
R_s	Stability parameter
t	Time, sec
T	Wave period, sec
V	Mean longshore current speed, m/sec
x	Longshore coordinate, m

X_b	Width of surf zone, m
y	Shoreline position, m
y_{diff}	Shoreline position difference, m
y_{G1}	Length of groin on left side of cell 1, m
y_{GN}	Length of groin on right side of cell N, m
y_{LT}	Width of littoral zone, m
Y_{add}	Added shoreline width of a beach fill, m
Y_{diff}	Difference in calculated and measured shoreline positions, m
$\tan \beta$	Average nearshore bottom slope, deg
γ	Wave breaking proportionality constant
ϵ	Calculation scheme stability coefficient, m^2/sec
ϵ_1	Calculation scheme stability coefficient, m^2/sec
ϵ_2	Calculation scheme stability coefficient, m^2/sec
θ	Angle of wave crest to depth contour, deg
θ_o	Mean value of sinusoidally varying wave angle, deg
θ_1	Angle of wave ray started at Point 1 that will reach a given location (Point 2), deg
θ_b	Angle of wave crests to x-axis, deg
θ_{bs}	Angle of wave crests to the shoreline, deg
θ_D	Angle used to determine the value of the diffraction coefficient, deg
θ_G	Angle defined by Points 1 and 2 used to approximate angle θ_1 , deg
θ_s	Angle of shoreline to x-axis, deg
ρ	Density of water, kg/m^3
ρ_s	Density of sediment, kg/m^3
ΔQ	Change in longshore sand transport rate, m^3/sec
Δt	Time step, sec
ΔV	Change in volume of small beach section, m^3
Δx	Grid spacing alongshore, m
Δy	Change in shoreline position, m
'	Prime; denotes new time level

Program Variable Names

ABH Average berm height (also, D_B), m

BFDATE Array holding ending dates of beach fills

BFDATS Array holding starting dates of beach fills

BYP Groin bypassing factor

DDB Array holding depths at tips of detached breakwaters, m

DDG Array holding depths at seaward ends of diffracting groins and jetties, m

D50 Median grain size, mm

DCLOS Depth of closure (also, D_C), m

DLTZ Maximum depth of longshore sand transport (also, D_{LTO}), m

DT Time step, hr

DTW Time increment in the WAVES data file, hr

DX Longshore cell length, m

DZ Depth of offshore wave input, m

H Wave height, m

HCNGF Wave height change factor; a factor that can be applied to increase or decrease the input wave height

I As the first letter of a variable, denotes that the variable is an integer or an array of integers

IBF Toggle denoting existence of beach fills; no (0), yes (1)

IBFE Array holding grid cell numbers of end (right side) of beach fills

IBFS Array holding grid cell numbers of start (left side) of beach fills

ICONV Toggle specifying a conversion factor for whether metric (1) or American customary length units (2) will be input

IDB Toggle denoting existence of detached breakwaters; no (0), yes (1)

IDB1 Toggle denoting existence of a detached breakwater crossing the left boundary; no (0), yes (1)

IDBN Toggle denoting existence of a detached breakwater crossing the right boundary; no (0), yes (1)

IDG Toggle denoting existence of diffracting groins; no (0), yes (1)

INDG Toggle denoting existence of nondiffracting groins; no (0), yes (1)

IPRINT Toggle turning the time step display off (0) and on (1)

IRWN Toggle turning repeated warning messages on (1) and off (0)

ISMOOTH Number of calculation cells included in smoothing the shoreline to define the shape of a representative offshore contour
 ISBW Number of shoreline calculation cells per wave model element (valid only if an external wave model was used, NWD = 1)
 ISPW Number of shoreline calculation cells per wave model element
 ISW Toggle denoting existence of a seawall; no (0), yes (1)
 ISWBEG Beginning grid cell number of the seawall
 ISWEND Ending grid cell number of the seawall
 IXDB Array holding grid cell locations of detached breakwaters
 IXDG Array holding grid cell numbers of diffracting groins
 IXNDG Array holding grid cell numbers of nondiffracting groins
 IZH Integer variable holding compressed wave data
 K1 Longshore transport rate calibration parameter for oblique wave incidence
 K2 Longshore transport rate calibration parameter for longshore gradient in wave height
 NBF Number of beach fills during the simulation period
 NDB Number of detached breakwaters
 NDG Number of diffracting groins
 NN Number of calculation grid cells
 NNDG Number of nondiffracting groins
 NOUT Number of intermediate outputs (not including that from the last time step, which is a default output)
 NWD Toggle specifying whether an external wave model was used to provide a nearshore wave data input file; no (0), yes (1)
 NWAVES Number of wave components per time step
 PERM Array of groin permeability coefficients (empirical)
 SIMDATE Ending date of the simulation
 SIMDATS Starting date of the simulation
 SLOPE2 Representative bottom slope near groins
 STAB Stability parameter
 TOUT Array holding dates or time steps of intermediate printouts
 TRANDB Array holding transmission coefficients of detached breakwaters (empirical)
 WDATS Starting date of WAVES file
 X Longshore coordinate, m

Y Shoreline position, m

YADD Added shoreline width of a beach fill after adjustment of fill to equilibrium, m

YDB Array holding distances of detached breakwater tips measured from the x-axis, m

YDIFF Difference in calculated and measured shoreline positions, m

YG1 Length of groin on left side of cell 1, m

YGN Length of groin on right side of cell N, m

YLT Width of littoral zone, m

YNDG Array holding lengths of nondiffracting groins, measured from the x-axis, m

Z As a first letter, denotes an angle

ZCNGA Wave angle change amount; an angle (positive or negative) that can be applied to shift all input wave angles by the specified amount, deg

ZCNGF Wave angle change factor; a factor that can be applied to the input wave angle which acts to increase or decrease the wave angle range (compress or expand the wave rose)

APPENDIX F: INDEX

- Beach change models
 - analytical model, 21
 - fully 3-D model, 23
 - profile erosion model, 22
 - schematic 3-D model, 23
 - shoreline change model, 22
- Beach fill
 - added distance for, 91
 - as direct shoreline change, 54
 - representation of, 90, 146
- Beach profile shape
 - discussion of, 56
 - equation for, 56
 - equilibrium shape, 56
- Beach profile shape,
 - width of littoral zone, 57
- Berm elevation
 - in shoreline change equation, 50
- Boundary conditions
 - default, 99
 - equations for, 86, 87
 - gated, 42, 100
 - general discussion of, 41
 - pinned beach, 42, 87, 101
- Breaker index
 - equation for, 65
- Bypassing
 - discussion of, 88
 - equation for, 89
- Calibration
 - definition of, 44
- Coastal experience
 - advantages and disadvantages, 15
 - and calibration procedure, 44
- Contour modification
 - discussion of, 69
- DEPTH file
 - discussion of, 126
- Depth of closure
 - determination of, 57
 - for Oarai Beach, 57
 - for Oceanside Beach, 57
 - in shoreline change equation, 50
 - Lakeview Park, 156
 - predictive equation for, 61
- Depth of longshore transport
 - discussion of, 54
 - equation for, 55
 - maximum, 55
- Detached breakwaters
 - parameters describing, 142
- Diffraction
 - diffraction coefficient, 67
 - multiple, 80
- Error messages
 - discussion of, 136
- External wave transformation model
 - calculation procedure, 74
- GENESIS
 - acronym for, 9
 - basic assumptions of, 48
 - boundary conditions, 86
 - capabilities and limitations, 20
 - cautions, 13
 - coordinate system and grid for, 97
 - design mode, 32
 - external wave model, 61
 - general structure of, 97
 - history of, 11
 - input data, 33
 - Input files for, 102
 - internal wave model, 61
 - number of structures in, 139
 - numerical solution scheme of, 81
 - output files for, 129
 - sand transport calculation
 - domains, 77
 - scoping mode, 32
 - theory of, 47
 - wave energy windows, 77
- Groins
 - complex configurations of, 143
 - legal representation of, 143
- Input data
 - list of, 36
 - minimum requirements, 34
- Internal wave transformation model
 - calculation procedure, 62
- Lakeview Park
 - as case study, 149
 - calibration and verification for, 166
 - five-year simulation for, 175
 - location map, 150
 - model sensitivity tests, 169
 - transport rate coefficients for, 170
 - WAVES file for, 161
- Line sources and sinks
 - in shoreline change equation, 50
 - uses of, 54
- Longshore sand transport rate
 - effective threshold for, 94
 - empirical predictive equation, 52
 - gross, 93
 - in shoreline change equation, 50
 - multiple wave sources for, 92
 - net, 93
 - practical considerations of, 91
 - transport rate coefficients, 52
- Numerical solution
 - diffusion (heat) equation, 82
 - discussion of, 81
 - equations for implicit scheme, 86
 - explicit scheme, 83
 - grid system for, 84
 - implicit scheme, 84
 - numerical and physical accuracy, 81
 - stability parameter for, 83
- Oarai Beach, 17
 - depth of closure of, 57
 - shoreline change at, 18
- Oceanside Beach
 - depth of closure of, 57
- OUTPUT file
 - discussion of, 129, 132
- Planning process
 - and shoreline change models, 25
 - comprehensive planning, 25
 - five general issues in, 28
 - role of shoreline change modeling, 29
 - single-project planning, 25
- RCPWAVE
 - acronym for, 74
- Representative offshore contour
 - discussion of, 73
- Sand bypassing
 - at groins and jetties, 54
 - discussion of, 88
 - equation for, 89
- Sand transmission
 - discussion of, 88

permeability factor for, 89
 Sand transport calculation domains
 definition of, 77
 examples of, 78
 Seawall
 discussion of, 90
 representation of, 90, 145
 SEAWL file
 discussion of, 125
 example of, 126
 Sensitivity testing
 definition of, 45
 SETUP file
 example of, 132
 SHORC file
 discussion of, 136
 Shoreline change
 governing equation of, 50
 Shoreline change model
 duration of simulation, 17
 history, 16
 role in planning process, 29
 spatial extent, 19
 SHORL file
 discussion of, 123
 example of, 123
 SHORM file
 discussion of, 124
 example of, 125
 Snell's law
 equation for, 65
 Stability parameter
 equation for, 83
 START file
 general discussion, 104
 lines in, 104
 Structures
 detached breakwaters, 142
 general effects of, 138
 groins, 143
 illegal positioning, 141
 legal positioning, 140
 permissible number of, 139
 representation of, 138
 rules for placement, 139
 seawalls, 145
 time-varying configurations, 148
 Transmission coefficient
 for transmissive detached breakwaters,
 72
 properties of, 71
 Transport rate coefficients
 as model transport parameters, 53
 definition of, 52
 empirical values of, 53
 for Lakeview Park, 170
 Variability in coastal processes
 problem of, 42
 Verification
 definition of, 44
 Warning messages
 discussion of, 136
 Wave angle
 definition of, 65
 Wave breaking
 under combined transformations, 67
 Wave calculation
 angle, 65
 breaker index, 65
 breaking wave height, 67
 depth-limited breaking, 65
 external wave model (RCPWAVE), 74
 external wave model, 61
 general discussion of, 61
 internal wave model 61, 62
 limiting wave steepness, 76
 multiple diffraction, 80
 representative offshore contour
 73
 Snell's law, 65
 transmission, 71
 Wave energy windows
 discussion of, 77
 examples of, 78
 Wave transmission
 for Lakeview Park breakwaters,
 171
 transmission coefficient, 71
 WAVES file
 discussion of, 126
 for Lakeview Park, 161
 with nearshore wave data, 130
 without nearshore wave data, 130